快速指南

RIGOL

文件编号 QGA03009-1110

2014 年 02 月

DM3058/DM3058E 数字万用表

版权信息

1. 北京普源精电科技有限公司版权所有。
2. 公司产品受已获准及尚在审批的中华人民共和国专利的保护。
3. 本手册提供的信息取代以往出版的所有资料。
4. 本公司保留改变规格及价格的权利。

注：RIGOL 是北京普源精电科技有限公司的注册商标。

一般安全概要

了解下列安全性预防措施，以避免受伤，并防止损坏本产品或与本产品连接的任何产品。为避免可能的危险，请务必按照规定使用本产品。

只有授权人员才能执行维修程序。

避免起火和人身伤害。

使用正确的电源线。只允许使用所在国家认可的本产品专用电源线。

将产品接地。本产品通过电源的接地导线接地。为避免电击，接地导体必须与地相连。在连接本产品的输入或输出端之前，请务必将本产品正确接地。

查看所有终端额定值。为避免起火和过大电流的冲击，请查看产品上所有的额定值和标记说明，请在连接产品前查阅产品手册以了解额定值的详细信息。

请勿开盖操作。外盖或面板打开时，请勿运行本产品。

使用合适的保险丝。请使用本产品指定类型和额定指标的保险丝。

避免电路外露。电源接通后，请勿接触外露的接头和元件。

怀疑产品出故障时，请勿进行操作。如果您怀疑本产品已经出故障，可请 **RIGOL** 授权的专业维修人员进行检查。

保持适当的通风。

请勿在潮湿环境下操作。

请勿在易燃易爆的环境下操作。

请保持产品表面的清洁和干燥。

所有型号的干扰试验符合 A 类标准，基于 EN 61326:

1997+A1+A2+A3 的标准，但是不符合 B 类标准。

输入端子保护极限

保护极限是为输入端子定义的：

1. 主输入 (HI 和 LO) 端子。

HI 和 LO 输入端子用于电压、电阻、电容、连通性、频率和二极管测试测量。这两个端子定义了以下两个保护极限：

- 1) HI 到 LO 保护极限。HI 到 LO 保护极限为 1000 VDC 或 750 VAC，这也是可测量的最大电压。此极限也可表示为最大 1000Vpk。

2) LO 到接地保护极限。LO 输入端子相对于地来说最大可以安全地“浮动”到 500Vpk。

HI 端子的保护极限相对于地来说最大为 1000Vpk。因此，“浮动”电压和测得的电压之和不得超过 1000Vpk。

2. 取样 (HI Sense 和 LO Sense) 端子。

HI Sense 和 LO Sense 端子用于四线电阻测试测量。这两个端子定义了以下两个保护极限：

1) HI Sense 到 LO Sense 保护极限。HI Sense 和 LO Sense 保护极限为 200Vpk。

2) LO Sense 到 LO 保护极限。LO Sense 和 LO 保护极限为 2Vpk。

3. 电流输入(I)端子。

I 和 LO 端子用于电流测试测量。后面板保险丝对流过 I 端子的电流提供最大 10A 保护极限。

注意：电流输入端子的电压与 LO 端子的电压差不多。为了维持良好的保护，只能用指定类型和等级的保险丝来替代该保险丝。

IEC 测量类别 II 过压保护

为了避免电击危险，DM3058/DM3058E 数字万用表为同时满足以下两个条件的电力干线连接提供过压保护。

1. HI 和 LO 输入端子在测量类别 II 条件下（如下所述）连接到电力干线。
2. 电力干线的最大线路电压为 600VAC。

警告：IEC 测量类别 II 包括通过分支电路上的某一插座连接到电力干线的电气装置。这些装置包括大多数小家电、测试设备以及插到支路插座上的其他设备。

DM3058/DM3058E 数字万用表可用于进行这样的测量：HI 和 LO 输入端子连接到这些设备中的电力干线（最高 600VAC），或自身连接到支路插座。不过，DM3058/DM3058E 的 HI 和 LO 输入端子不能连接到永久安装的电气装置中的电力干线，如主断路器配电盘、分配电盘断路器或永久连线的电机。这些装置和电路容易出现超过 DM3058/DM3058E 保护极限的过压现象。

注意：高于 600VAC 的电压只能与电力干线断开的电路中测量。不过，与电力干线断开的电路中也存在瞬态过电压。DM3058/DM3058E 可以安全地承受高达 4000Vpk 的偶然瞬态过电压。请勿使用该设备来测量瞬态过电压可能超出这一水平的电路。

安全术语和符号

本手册中的术语。以下术语可能出现在本手册中：



警告。警告性声明指出可能会危害生命安全的条件和行为。



注意。注意性声明指出可能导致此产品和其它财产损坏的条件和行为。



CAT I (1000V) IEC测量类别I。HI-LO端的最大可测量电压为1000Vpk。



CAT II (600V) IEC测量类别II。在类别II过压情况下，输入可能连接到电力干线（高达 600 VAC）。

产品上的术语。以下术语可能出现在产品上：

危险表示您如果进行此操作可能会立即对您造成损害。

警告表示您如果进行此操作可能不会立即对您造成损害。

注意表示您如果进行此操作可能会对本产品或其它财产造成损害。

产品上的符号。以下符号可能出现在产品上：



高电压



安全警告



保护性接地端



壳体接地端



测量接地端

目录

目录.....	V
必要的检查.....	1
如何调整手柄.....	4
如何连接电源.....	5
如何连接测试引线.....	7
如何连接 USB、RS232、LAN 和 GPIB 接口.....	13
常见故障处理.....	14
联系我们.....	15

必要的检查

1. 检查是否存在因运输造成的损坏。

如发现包装纸箱或泡沫塑料保护垫严重破损，请先保留，直到整机和附件通过电性和机械性测试。

2. 检查整机。

如发现仪器外观破损，请和负责此业务的 **RIGOL** 经销商或 **RIGOL** 当地办事处联系。

如果因运输造成仪器的损坏，请注意保留包装。通知运输部门和负责此业务的 **RIGOL** 经销商。**RIGOL** 会安排维修或更换。

3. 检查附件。

关于提供的附件明细，在本手册下面已进行说明，您可以参照说明检查附件是否有缺失。

如发现附件缺少或损坏，请和负责此业务的 **RIGOL** 经销商或 **RIGOL** 的当地办事处联系。

I. 整机外观

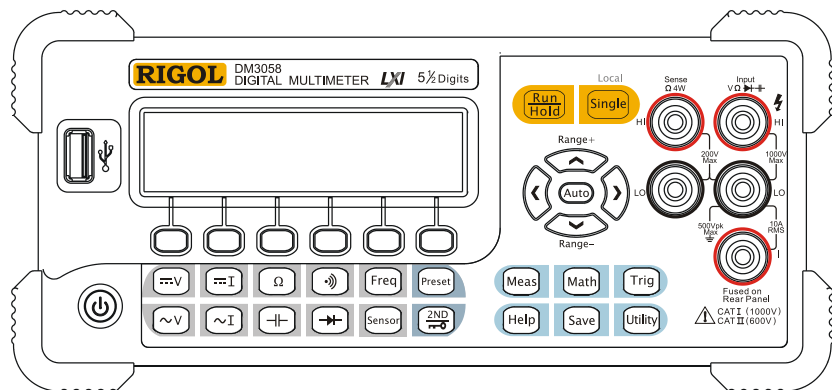

前面板示意图

II. 标准附件示意图



一根符合所在国标准的电源线



一根 USB 数据线



表笔 2 根



鳄鱼夹 2 个（配合表笔使用）



一张光盘*



备份保险丝



一本快速指南



一份保修卡

注*：光盘内含《用户手册》、上位机应用软件等。

III. 选配件示意图



RS232 串口线



开尔文测试夹

注意：

所有附件（标准附件和选购附件），请向当地的 **RIGOL** 办事处订购。

如何调整手柄

要调整数字万用表的手柄，请握住表体两侧的手柄并向外拉。然后将手柄旋转到所需位置。操作方法如下图所示。

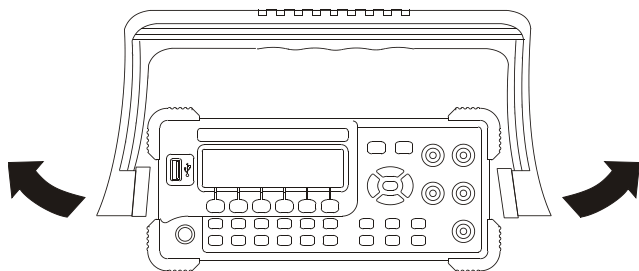

调整手柄

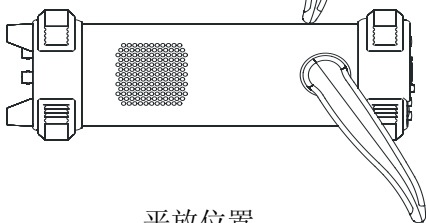
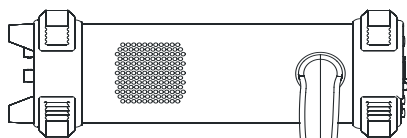
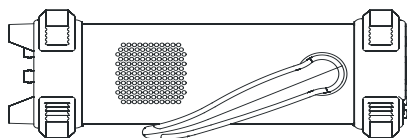

平放位置

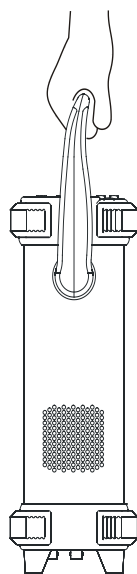

移动位置

如何连接电源

连接电源线之前，请根据您的电源电压选择万用表后面板的电压选择器，然后按下图连接电源并给仪器上电。

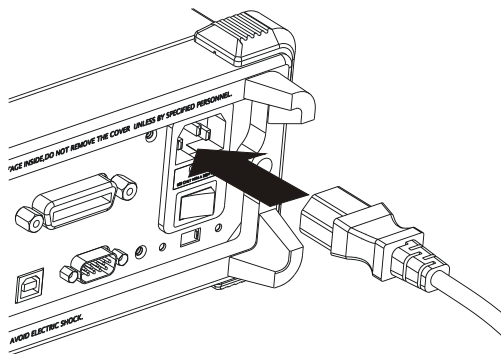

电源连接示意图

电源线连接完毕后，打开电源插孔下面的电源开关，然后按下前面板的电源键。此时，请检查仪器是否正常启动，如没有启动，请按照下面步骤进行检查：

1. 检查电源线是否接触良好；
2. 检查后面板电源开关是否已经打开；
3. 如经检查无误后，仪器仍未启动，请检查保险丝是否已熔断，如有必要，请更换保险丝。
4. 若经上述检查无误后，仪器仍未启动，请联系 **RIGOL** 技术支持部或当地经销商进行解决。

电源电压选择

万用表能够工作于多种电源标准，必须根据供电电压对其进行设置。如果所选的电源电压不同于使用时的工作电压，必须修改万用表的电源电压设置。电源电压选择器位于万用表后面板电源开关下方。

更换电力保险丝

电力保险丝位于万用表后面板的保险丝座内，万用表在出厂时已安装了一个电力保险丝。该保险丝是一种快熔、防爆、F300mA、5×20mm的保险丝。

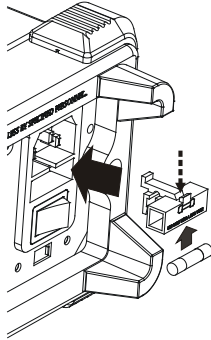

更换电力保险丝

操作步骤：

1. 拔掉电源线，用一字螺丝刀按下卡舌（虚线箭头所指位置），之后拔出保险丝座。
2. 在电压选择开关处选择正确的电压档位。
3. 放置好保险丝后，将保险丝座重新装入卡槽中。



注意。为避免电击或火灾，请勿使用不合适的保险丝或将保险丝支架短路。

如何连接测试引线

1. 直流电压测量

如下图所示连接测试引线和被测电路，红色测试引线接高电压 HI 端，黑色测试引线接低电压 LO 端。

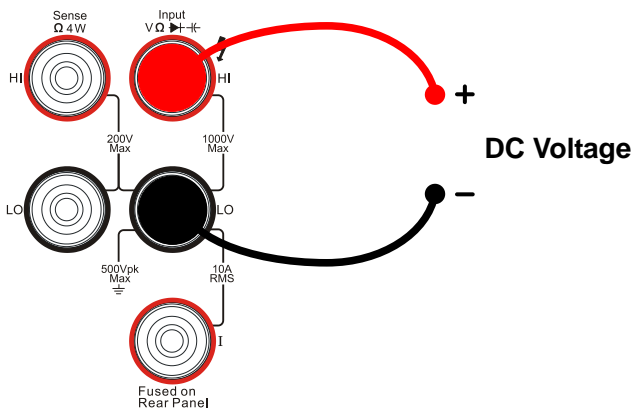

2. 交流电压测量

如下图所示连接测试引线和被测电路，红色测试引线接高电压 HI 端，黑色测试引线接低电压 LO 端。

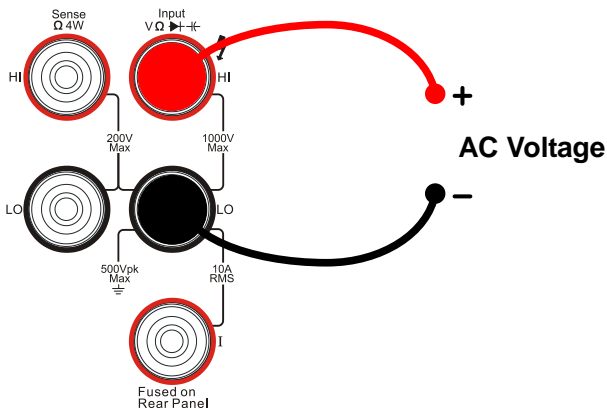

3. 直流电流测量

如下图所示连接测试引线和被测电路，红色测试引线接高电压 HI 端，黑色测试引线接低电压 LO 端。

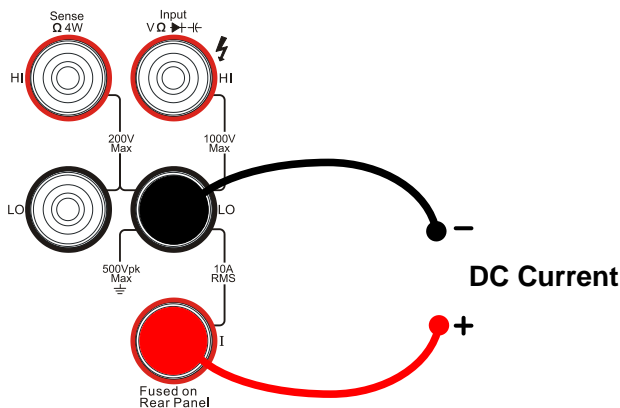

4. 交流电流测量

如下图所示连接测试引线和被测电路，红色测试引线接高电压 HI 端，黑色测试引线接低电压 LO 端。

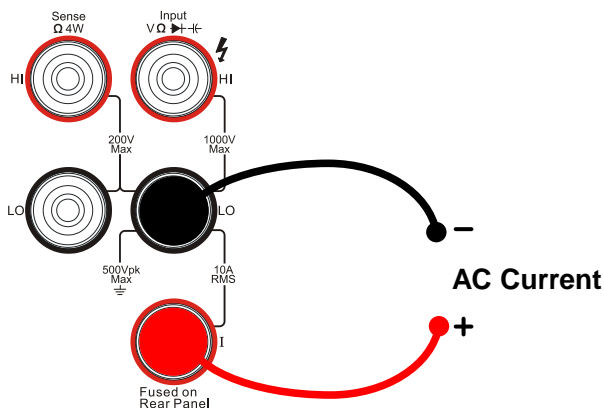

5. 二线电阻测量

如下图所示连接测试引线和被测电阻，红色测试引线接高电压 HI 端，黑色测试引线接低电压 LO 端。

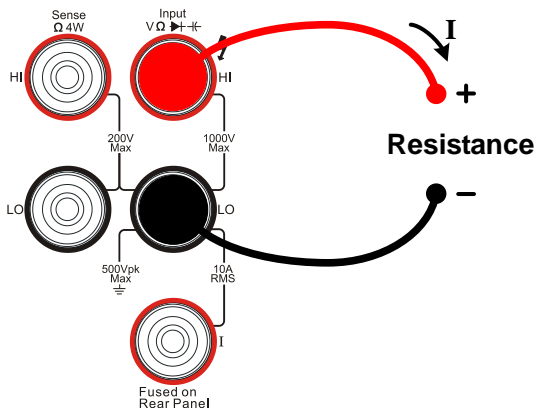

6. 四线电阻测量

如下图所示连接测试引线，红色测试引线接高电压 HI 端，黑色测试引线接低电压 LO 端。

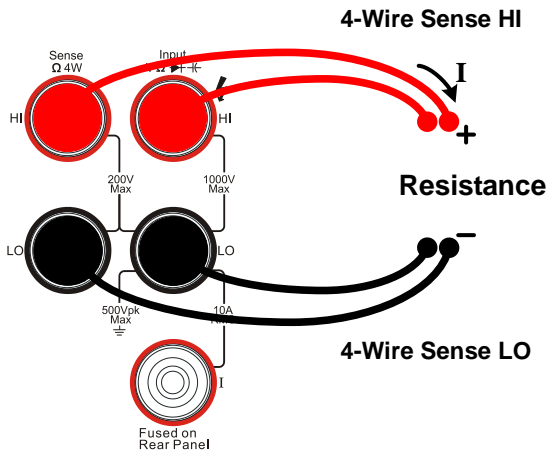

7. 电容测量

如下图所示将测试引线接于被测电容两端，红色测试引线接电容的正极，黑色测试引线接入电容的负极。

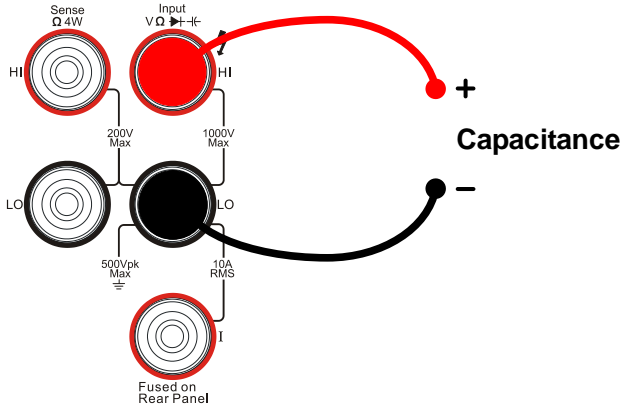

8. 连通性测量

如下图所示连接测试引线和被测电路，红色测试引线接高电压 HI 端，黑色测试引线接低电压 LO 端。

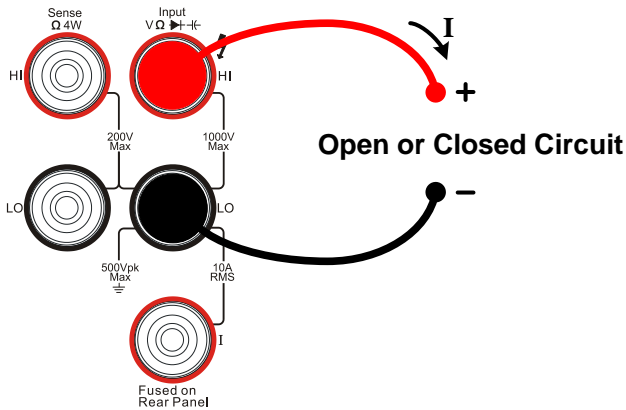

9. 二极管测量

如下图所示连接测试引线 and 被测二极管，红色测试引线接高电压 HI 端，黑色测试引线接低电压 LO 端。

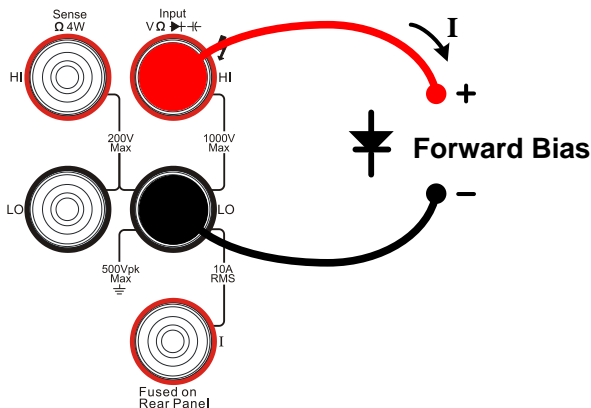

10. 频率/周期测量

如下图所示连接测试引线，红色测试引线接高电压 HI 端，黑色测试引线接低电压 LO 端。

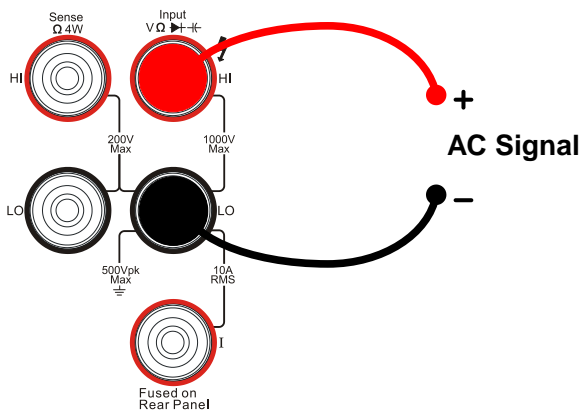

11. 任意传感器测量

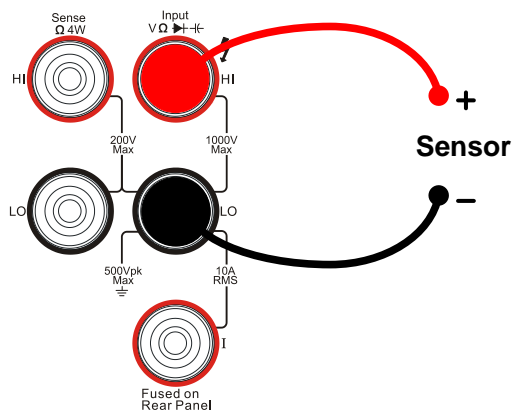

电压、电阻、热电偶、频率型传感器连接

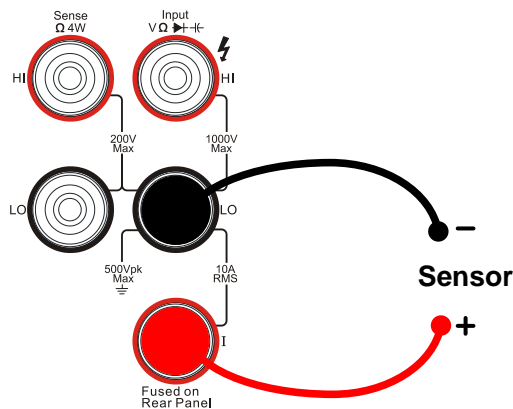

电流型传感器连接

如何连接 USB、RS232、LAN 和 GPIB 接口

DM3058/DM3058E 数字万用表有丰富的接口，这些接口的连接方法如下所示：

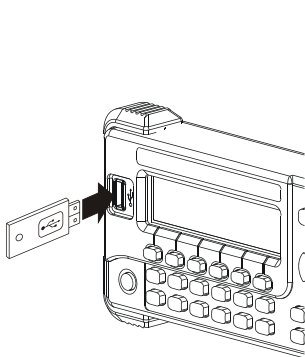

前面板 USB Host 接口连接

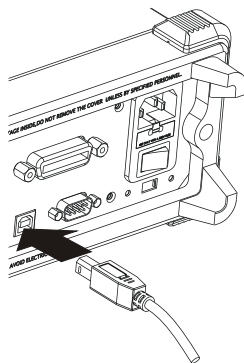

后面板 USB Device 接口连接

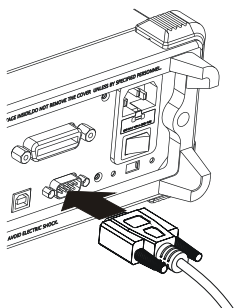

RS232 接口连接

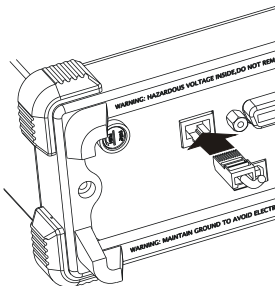

LAN 接口连接*

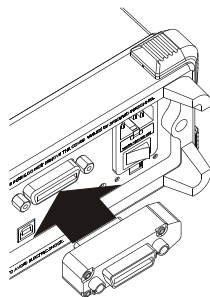

GPIB 口连接*

注*：仅 DM3058 支持 LAN 和 GPIB 接口。

常见故障处理

1. 如果按下电源开关，万用表仍然黑屏，没有任何显示：

- (1) 检查电源插头是否接好。
- (2) 检查背面的电源总开关是否已经打开。
- (3) 检查背面电源输入的保险丝是否已经熔断。如果已经熔断，请按要求更换保险管。
- (4) 做完上述检查后，重新启动仪器。
- (5) 如果仍然无法正常使用本产品，请与 **RIGOL** 维修中心联络，让我们为您服务。

2. 接入一个电流信号，读数没有任何改变：

- (1) 检查表笔是否正确插入电流插孔和 LO 插孔。
- (2) 检查背面的电流档位保险管是否已经熔断。
- (3) 检查测量档位是否已经正确切换到 DCI 或者 ACI 档位。
- (4) 检查是否由于输入的是 ACI，而档位却处于 DCI 档位。

3. 当接入一个 DC 电源信号，读数显示不正常：

- (1) 检查表笔是否正确插入电流插孔和 LO 插孔。
- (2) 检查背面的电流档位保险管是否已经熔断。
- (3) 检查测量档位是否已经正确切换到 DCI 或者 DCV 档位。
- (4) 检查是否由于输入的是 DCI，而档位却处于 ACI 档位。

联系我们

如您在使用此产品或本手册的过程中有任何问题或需求，可与

RIGOL 联系：

电子邮箱：service@rigol.com

网 址：www.rigol.com

Quick Guide

RIGOL

Publication number QGA03109-1110

Feb. 2014

DM3058/DM3058E Digital Multimeter

© 2008 RIGOL Technologies, Inc.

All Rights Reserved

Copyright

- © 2008 RIGOL Technologies, Inc. All Rights Reserved.
- RIGOL products are protected by patent laws in and outside of the P.R. China.
- Information in this publication replaces all previous corresponding material.
- RIGOL reserves the right to modify or change part of or all the specifications and pricing policies at company's sole decision.

NOTE:

RIGOL is registered trademark of **RIGOL** Technologies, Inc.

Safety Notice

Review the following safety precautions carefully before operating the instrument to avoid any personal injuries or damages to the instrument and any products connected to it.

The instrument should be serviced by qualified personnel only.

Avoid Fire or Personal Injury.

Use Proper Power Cord. Use the power cord designed for the instrument as authorized in your country only.

Ground the Instrument. The instrument is grounded through the grounding conductor of the power cord. To avoid electric shock the instrument grounding conductor(s) must be grounded properly before making connections to the input or output terminals of the instrument.

Observe all Terminal Ratings. To avoid fire or shock hazard, observe all ratings and marks on the instrument. Follow the user's guide for further ratings information before making connections to the instrument.

Do not Operate Without Covers. Do not operate the instrument with covers or panels removed.

Use Proper Fuse. Use the fuse of the type, voltage and current ratings as specified for the instrument.

Avoid Circuit or Wire Exposure. Do not touch exposed connections and components when power is on.

Do not Operate With Suspected Failures. If suspected damage occurs with the instrument, have it inspected by qualified service personnel before further operations.

Do not Operate in Wet/Damp Conditions.

Do not Operate in an Explosive atmosphere.

Keep Product Surfaces Clean and Dry.

The disturbance test of all the models meet the limit values of A in the standard of EN 61326: 1997+A1+A2+A3, but can't meet the limit values of B.

Input Terminal Protection Limitation

Protection limitation is defined for the input terminal:

1. Main input (HI and LO) terminal

HI and LO terminals are used for Voltage, Resistance, Capacitance, Continuity, Frequency and Diodes measurement. Two protection limitations are defined:

- 1) **HI-LO** protection limitation: 1000VDC or 750VAC. It is the maximum measurable voltage. The limitation can be expressed as 1000Vpk.

- 2) **LO-ground protection limitation.** **LO** terminal can safely “float” 500Vpk relative to the ground.

The maximum protection limitation of **HI** terminal relative to the ground is 1000Vpk. Therefore, the sum of the “float” voltage and the measured voltage cannot exceed 1000Vpk.

2. **Sampling (HI Sense and LO Sense) terminal**

HI Sense and **LO Sense** are used for 4-Wire Resistance Measurement. Two protection limitations are defined:

- 1) **HI Sense-LO Sense** protection limitation: 200Vpk.
- 2) **LO Sense-LO** protection limitation: 2Vpk.

3. **Current input (I) terminal**

I and **LO** terminal are used for current measurement. The maximum current which go through the **I** terminal is limited to 10A by the fuse on the rear panel.

NOTE: Voltage on the current input terminal corresponds to voltage on **LO** terminal. To obtain favorable protection, specified fuse should be used.

IEC Measurement Category II Overvoltage Protection

To protect against the danger of electric shock, DM3058/DM3058E provides overvoltage protection for line-voltage mains connections meeting both of the following conditions:

1. The **HI** and **LO** input terminals are connected to the mains under Measurement Category II conditions, defined below.
2. The mains are limited to a maximum line voltage of 600VAC.

WARNING: IEC Measurement Category II includes electrical devices connected to mains at an outlet on a branch circuit. Such devices include most small appliances, test equipment, and other devices that plug into a branch outlet or socket.

DM3058/DM3058E may be used to make measurements with the **HI** and **LO** inputs connected to mains in such devices (up to 600VAC), or to the branch outlet itself. However, DM3058/DM3058E may not be used with its **HI** and **LO** inputs connected to mains in permanently installed electrical devices such as the main circuit-breaker panel, sub-panel disconnected boxes, or permanently wired motors. Such devices and circuits are subject to overvoltage that may exceed the protection limits of DM3058/DM3058E.

NOTE: Voltages above 600VAC may be measured only in circuits that are isolated from mains. However, transient overvoltage is also present on circuits that are isolated from mains. DM3058/DM3058E is designed to safely withstand occasional transient overvoltage up to 4000Vpk. Do not use this equipment to measure circuits where transient overvoltage could exceed this level.

Safety Terms and Symbols

Terms in This Guide. These terms may appear in this manual:



WARNING: Warning statements indicate the conditions or practices that could result in injury or loss of life.



CAUTION: Caution statements indicate the conditions or practices that could result in damage to this product or other property.



CAT I (1000V) IEC Measurement Category II. The highest measureable voltage is 1000Vpk in the HI-LO terminal.



CAT II (600V): IEC Measurement Category II. Inputs may be connected to mains (up to 600VAC) under Category II overvoltage conditions.

Terms on the Product. These terms may appear on the product:

DANGER indicates an injury or hazard that may immediately happen.

WARNING indicates an injury or hazard that may not immediately happen.

CAUTION indicates that a potential damage to the instrument or other property might occur.

Symbols on the Product. These symbols may appear on the product:



**Hazardous
Voltage**



**Safety
Warning**



**Protective
Earth
Terminal**



**Chassis
Ground**



**Test
Ground**

Contents

Contents	V
Necessary Inspection.....	1
Handle Adjustment.....	4
To Connect Power Cord.....	5
To Connect Test Lead	7
To Connect USB, RS232, LAN and GPIB Ports.....	13
Troubleshooting	14
Contact Us.....	15

Necessary Inspection

1. Inspect the shipping container for damage.

Keep the damaged shipping container or cushioning material until the contents of the shipment have been checked for completeness and the instrument has been checked mechanically and electrically.

2. Inspect the instrument.

In case there is any mechanical damage or defect, notify the **RIGOL** Sales Representative. If the shipping container is damaged, or the cushioning materials show signs of stress, notify the carrier as well as the **RIGOL** sales office. Keep the shipping materials for the carrier's inspection.

3. Check the accessories.

Accessories supplied with the instrument are listed in the following pages.

If the contents are incomplete or damaged, notify the **RIGOL** Sales Representative.

I. Front Panel of the Instrument

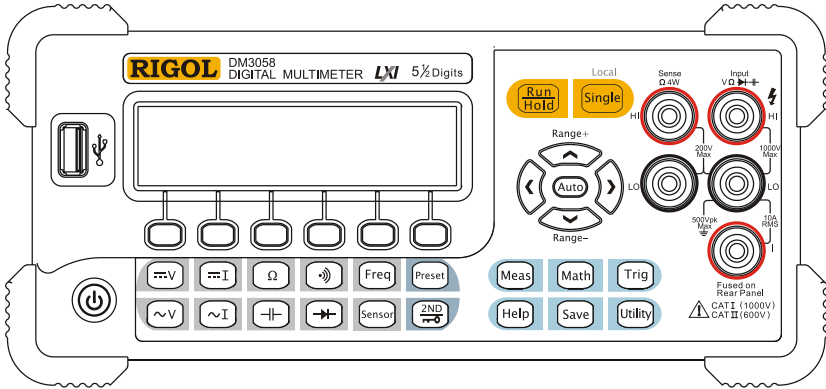

Front Panel

II. Standard Accessory



A Power Cord



A USB Cable



Two Test Leads



Two Alligator Clips
(Use with the test lead)



A CD-ROM*



Backup Fuse



A Quick Guide

NOTE*:

The CD-ROM includes 《User's Guide》 and Application Software.

III. Optional Accessories

RS232 Cable



Kelvin Test Clips

NOTE:

All the accessories (standard and optional) are available by contacting your local **RIGOL** office.

Handle Adjustment

To adjust the handle position of DM3058/DM3058E Multimeter, please grip the handle by the sides and pull it outward. Then, rotate the handle to the desired position as shown in the following figure.

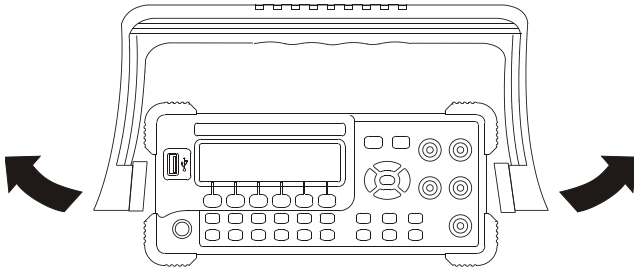

To Adjust the Handle

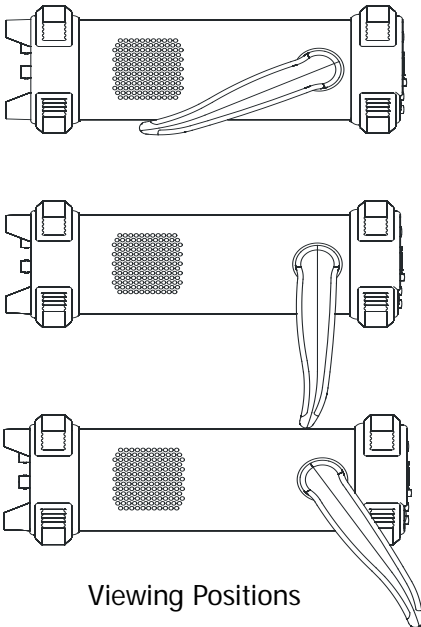

Viewing Positions

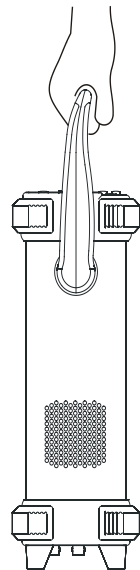

Carrying Position

To Connect Power Cord

Before you connect the instrument to a power source, please select the voltage selector according to the power supply. Then, connect the power cord as shown in the following figure.

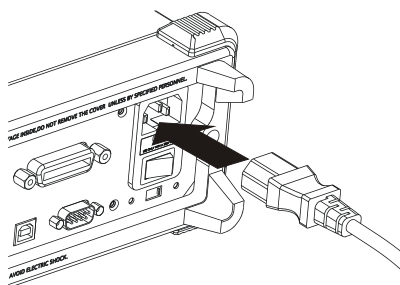

To Connect Power Cord

Turn on the power switch on the rear panel, then press the power key on the front panel to start up the Multimeter.

If unable to start up the Multimeter, take the following steps:

1. Check the power cord connection;
2. Check if the power switch on the rear panel has been turned on;
3. After the inspections, if the power key is not lit, please take out the fuse and check, refer to the fuse specification shown in the User' Guide to change the fuse if needed.
4. After the above inspections, the power key is still not lit, please contact **RIGOL** for help.

Power Selection

The Multimeter operates on multiple power distribution standards and must be set up to operate on the line voltage that will power it. If the selected line voltage does not match the power that the Multimeter will be plugged into, the Multimeter's linevoltage setting must be changed. The power selector is under the power switch on the rear panel.

To change the fuse

The fuse located in the rear panel of the Multimeter, it is a kind of fast-melt, no-burst, F300mA, 5×20mm one.

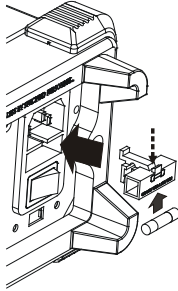

To Change the Fuse

Operation steps:

1. Disconnect the power. Use the Straight Screwdriver to press down the block (as the dashed line point out), and then pull out the seat of the fuse.
2. Choose the correct voltage shelves location in the voltage selected switches.
3. Enclose the seat of the fuse to the slot after placed the fuse.



WARNING: To avoid electric shock or fire, do not use makeshift fuses or short-circuit the fuse holder.

To Connect Test Lead

1. DC Voltage Measurement

Connect test leads as shown in the following figure; red test lead to the HI Terminal, black test lead to the LO Terminal.

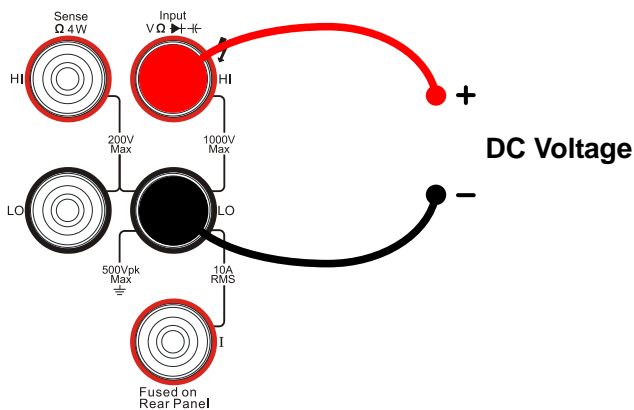

2. AC Voltage Measurement

Connect test leads as shown in the following figure; red test lead to the HI Terminal, black test lead to the LO Terminal.

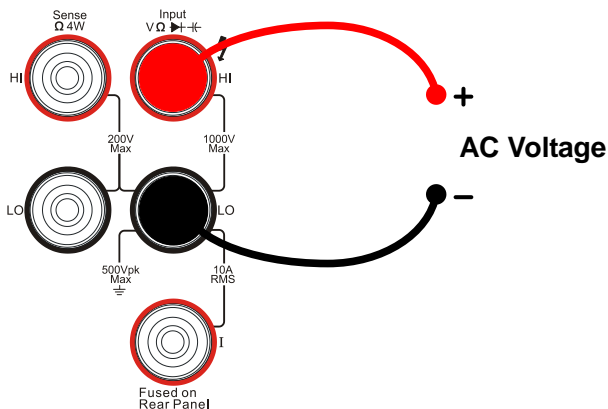

3. DC Current Measurement

Connect test leads as shown in the following figure; red test lead to the HI Terminal, black test lead to the LO Terminal.

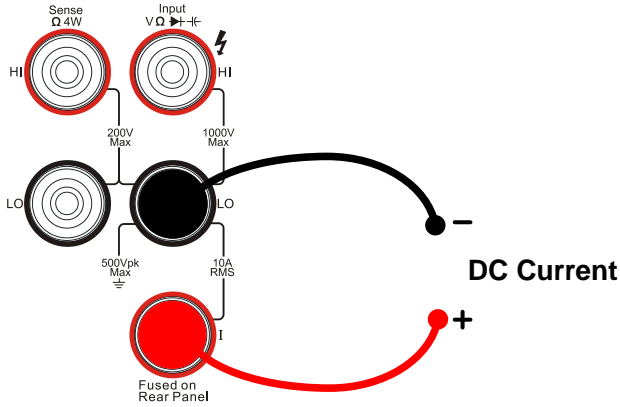

4. AC Current Measurement

Connect test leads as shown in the following figure; red test lead to the HI Terminal, black test lead to the LO Terminal.

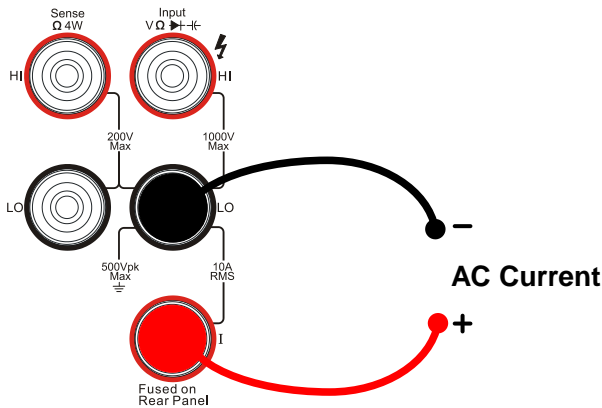

5. 2-Wire Resistance Measurement

Connect test leads as shown in the following figure; red test lead to the HI Terminal, black test lead to the LO Terminal.

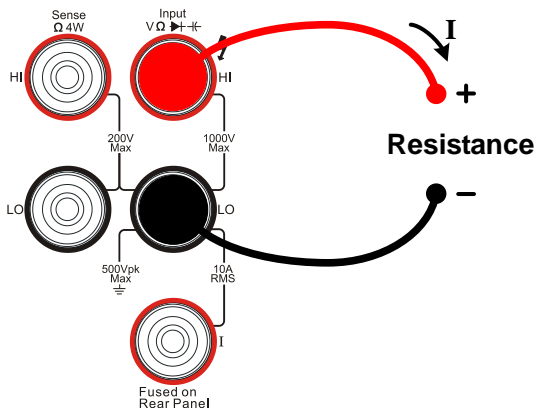

6. 4-Wire Resistance Measurement

Connect test leads as shown in the following figure; red test lead to the HI Terminal, black test lead to the LO Terminal.

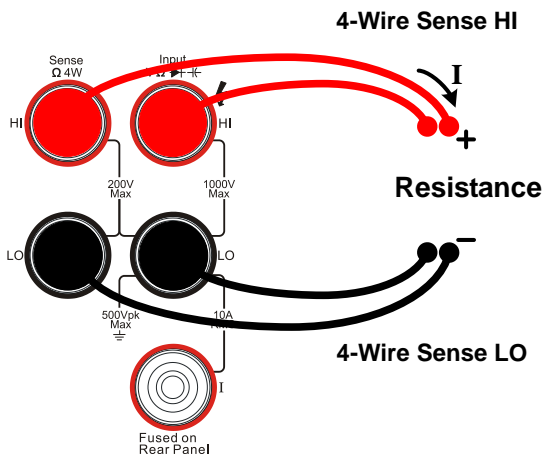

7. Capacitance Measurement

Connect test leads with the Capacitance as shown in the following figure; red test lead to the positive pole, black test lead to the negative pole.

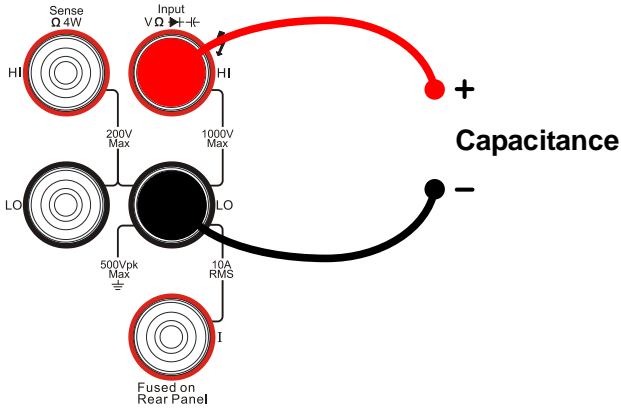

8. Continuity Testing

Connect test leads as shown in the following figure; red test lead to the HI Terminal, black test lead to the LO Terminal.

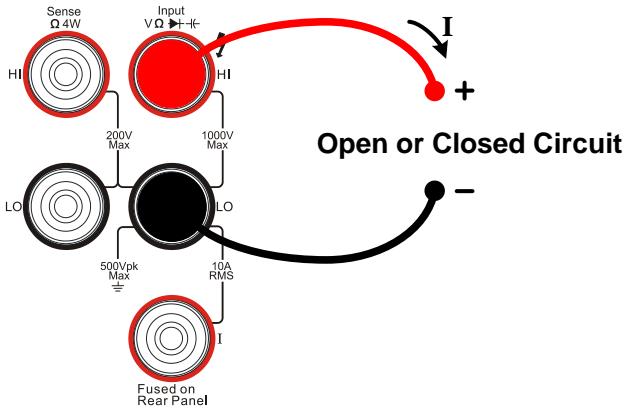

9. Diode Testing

Connect test leads as shown in the following figure; red test lead to the HI Terminal, black test lead to the LO Terminal.

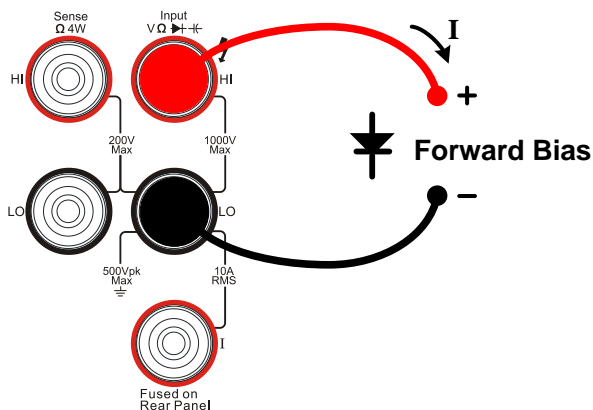

10. Frequency/Period Measurement

Connect test leads as shown in the following figure; red test lead to the HI Terminal, black test lead to the LO Terminal.

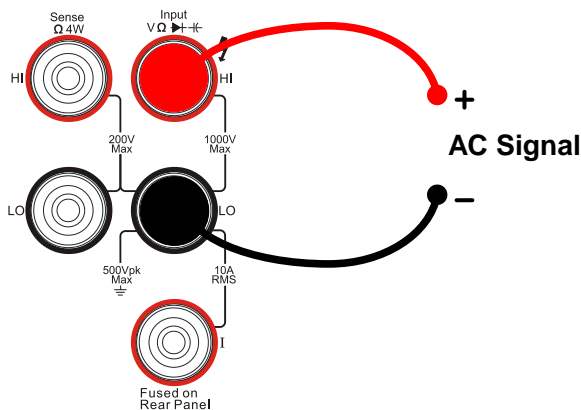

11. Sensor Measurement

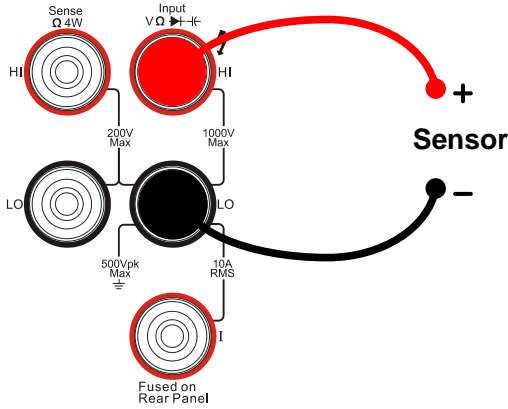

Voltage, Resistance, thermocouple and Frequency Sensor

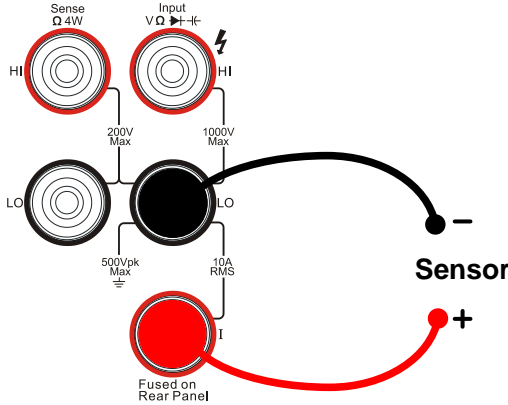

Current Sensor

To Connect USB, RS232, LAN and GPIB Ports

DM3058/DM3058E has plenty of I/O ports. To use any of the ports, follow the next instruction.

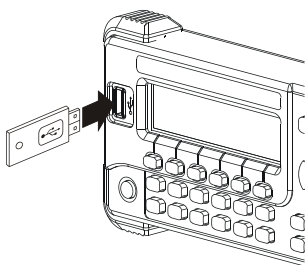

Connect USB Host

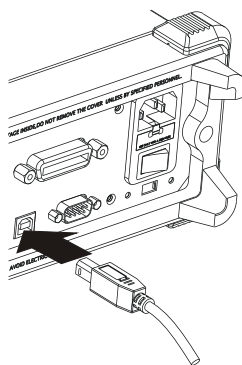

Connect USB Device

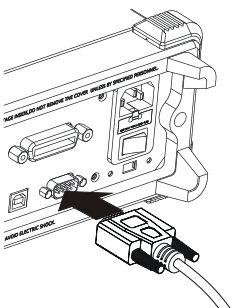

Connect RS232 Port

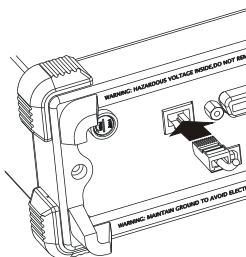

Connect LAN Port*

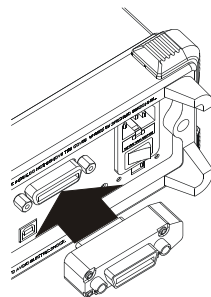

Connect GPIB Port*

Note*: LAN and GPIB interfaces are only supported by DM3058.

Troubleshooting

1. When pressing the power switch, the Multimeter has blank screen with nothing displaying:

- (1) Check if the power is correctly connected.
- (2) Check if the main power switch on the rear panel has been turned on.
- (3) Check if the safety fuse has been blown, replace it if necessary.
- (4) Restart the instrument.
- (5) If it still can't work properly, please contact **RIGOL** for help.

2. When connecting a current signal, the reading has not change:

- (1) Check if the test lead is correctly connected to current jack or the LO jack.
- (2) Check if the safety fuse in the current location on the rear panel has blown.
- (3) Check if the measure location has switched to the DCI or ACI place correctly.
- (4) Check whether the input is ACI but the shelves location is DCI.

3. When connecting a DC power signal, the reading display is abnormality:

- (1) Check if the test lead is correctly connected with the current jack or the LO jack.
- (2) Check if the safety fuse in the current location on the back panel has been blown.
- (3) Check the measure location has switched to the DCI or DCV place correctly.
- (4) Check whether the input is DCI but the shelves location is ACI.

Contact Us

If you have any problem or requirement when using our products or this manual, please contact RIGOL Technologies, Inc.

E-mail: service@rigol.com

Website: www.rigol.com