



RIGOL

DHO800/DHO900 Series

Digital Oscilloscope

Programming Guide

Jan.2024



Guaranty and Declaration

Copyright

© 2023 RIGOL TECHNOLOGIES CO., LTD. All Rights Reserved.

Trademark Information

RIGOL® is the trademark of RIGOL TECHNOLOGIES CO., LTD.

Notices

- RIGOL products are covered by P.R.C. and foreign patents, issued and pending.
- RIGOL reserves the right to modify or change parts of or all the specifications and pricing policies at the company's sole decision.
- Information in this publication replaces all previously released materials.
- Information in this publication is subject to change without notice.
- RIGOL shall not be liable for either incidental or consequential losses in connection with the furnishing, use, or performance of this manual, as well as any information contained.
- Any part of this document is forbidden to be copied, photocopied, or rearranged without prior written approval of RIGOL.

Product Certification

RIGOL guarantees that this product conforms to the national and industrial standards in China as well as the ISO9001:2015 standard and the ISO14001:2015 standard. Other international standard conformance certifications are in progress.

Contact Us

If you have any problem or requirement when using our products or this manual, please contact RIGOL.

E-mail: service@rigol.com

Website: <http://www.rigol.com>

Section	Description	Page
	List of Figures.....	XIX
	List of Tables.....	XX
1	Document Overview	1
2	Programming Overview	3
2.1	SCPI Command Overview	3
2.2	Remote Control	5
2.2.1	Remote Control via USB	6
2.2.2	Remote Control via LAN	6
2.3	Sequential Commands and Overlapped Commands	8
2.4	Compatible Command	10
3	Command System	12
3.1	Root Commands	12
3.1.1	:CLEar	12
3.1.2	:RUN	12
3.1.3	:STOP	13
3.1.4	:SINGle	14
3.1.5	:TFORce	14
3.2	:AUToset Commands	15
3.2.1	:AUToset	15
3.2.2	:AUToset:PEAK	16
3.2.3	:AUToset:OPENch	16
3.2.4	:AUToset:OVERlap	17
3.2.5	:AUToset:KEEPcoup	18
3.2.6	:AUToset:LOCK	18
3.2.7	:AUToset:ENABle	19
3.3	:ACQuire Commands	20
3.3.1	:ACQuire:AVERages	20
3.3.2	:ACQuire:MDEPth	21
3.3.3	:ACQuire:MEMDepth?	22
3.3.4	:ACQuire:TYPE	23
3.3.5	:ACQuire:SRATE?	24
3.3.6	:ACQuire:ULTRa:MODE	24
3.3.7	:ACQuire:ULTRa:TIMeout	26

3.3.8	:ACQuire:ULTRa:MAXFrame	26
3.4	:BUS<n> Commands	27
3.4.1	:BUS<n>:MODE	27
3.4.2	:BUS<n>:DISPlay	27
3.4.3	:BUS<n>:FORMat	28
3.4.4	:BUS<n>:EVENT	29
3.4.5	:BUS<n>:LABel	29
3.4.6	:BUS<n>:DATA?	30
3.4.7	:BUS<n>:EEXPort	31
3.4.8	:BUS<n>:POSition	32
3.4.9	:BUS<n>:THReshold	32
3.4.10	:BUS<n>:PARallel	34
3.4.10.1	:BUS<n>:PARallel:BUS	34
3.4.10.2	:BUS<n>:PARallel:CLK	35
3.4.10.3	:BUS<n>:PARallel:SLOPe	36
3.4.10.4	:BUS<n>:PARallel:WIDTh	36
3.4.10.5	:BUS<n>:PARallel:BITX	37
3.4.10.6	:BUS<n>:PARallel:SOURce	38
3.4.10.7	:BUS<n>:PARallel:ENDian	39
3.4.10.8	:BUS<n>:PARallel:POLarity	39
3.4.11	:BUS<n>:RS232	40
3.4.11.1	:BUS<n>:RS232:TX	41
3.4.11.2	:BUS<n>:RS232:RX	42
3.4.11.3	:BUS<n>:RS232:POLarity	42
3.4.11.4	:BUS<n>:RS232:PARity	43
3.4.11.5	:BUS<n>:RS232:ENDian	44
3.4.11.6	:BUS<n>:RS232:BAUD	45
3.4.11.7	:BUS<n>:RS232:DBITs	45
3.4.11.8	:BUS<n>:RS232:SBITs	46
3.4.12	:BUS<n>:IIC	47
3.4.12.1	:BUS<n>:IIC:SCLK:SOURce	47
3.4.12.2	:BUS<n>:IIC:SDA:SOURce	48
3.4.12.3	:BUS<n>:IIC:EXCHange	48
3.4.12.4	:BUS<n>:IIC:ADDRes	49
3.4.13	:BUS<n>:SPI	50
3.4.13.1	:BUS<n>:SPI:SCLK:SOURce	50
3.4.13.2	:BUS<n>:SPI:SCLK:SLOPe	51

3.4.13.3	:BUS<n>:SPI:MISO:SOURce	51
3.4.13.4	:BUS<n>:SPI:MOSI:SOURce	52
3.4.13.5	:BUS<n>:SPI:POLarity	53
3.4.13.6	:BUS<n>:SPI:MISO:POLarity	54
3.4.13.7	:BUS<n>:SPI:MOSI:POLarity	54
3.4.13.8	:BUS<n>:SPI:DBITs	55
3.4.13.9	:BUS<n>:SPI:ENDian	56
3.4.13.10	:BUS<n>:SPI:MODE	56
3.4.13.11	:BUS<n>:SPI:TIMEout:TIME	57
3.4.13.12	:BUS<n>:SPI:SS:SOURce	58
3.4.13.13	:BUS<n>:SPI:SS:POLarity	59
3.4.14	:BUS<n>:CAN	59
3.4.14.1	:BUS<n>:CAN:SOURce	60
3.4.14.2	:BUS<n>:CAN:STYPe	61
3.4.14.3	:BUS<n>:CAN:BAUD	62
3.4.14.4	:BUS<n>:CAN:SPOint	62
3.4.15	:BUS<n>:LIN	63
3.4.15.1	:BUS<n>:LIN:PARity	63
3.4.15.2	:BUS<n>:LIN:SOURce	64
3.4.15.3	:BUS<n>:LIN:STANdard	64
3.5	:BODeploT Commands	65
3.5.1	:BODeploT:ENABle	65
3.5.2	:BODeploT:RUNStop	66
3.5.3	:BODeploT:SWEEptype	67
3.5.4	:BODeploT:REF:IN	67
3.5.5	:BODeploT:REF:OUT	68
3.5.6	:BODeploT:STARt	68
3.5.7	:BODeploT:STOP	69
3.5.8	:BODeploT:POINts	70
3.5.9	:BODeploT:VOLTagE	70
3.6	:CHANnel<n> Commands	71
3.6.1	:CHANnel<n>:BWLimit	72
3.6.2	:CHANnel<n>:COUPLing	73
3.6.3	:CHANnel<n>:DISPlay	73
3.6.4	:CHANnel<n>:INVert	74
3.6.5	:CHANnel<n>:OFFSet	75
3.6.6	:CHANnel<n>:TCALibrate	75

3.6.7	:CHANnel<n>:SCALe	76
3.6.8	:CHANnel<n>:PROBe	77
3.6.9	:CHANnel<n>:LABel:SHOW	78
3.6.10	:CHANnel<n>:LABel:CONTent	78
3.6.11	:CHANnel<n>:UNITs	79
3.6.12	:CHANnel<n>:VERNier	80
3.6.13	:CHANnel<n>:POSition	80
3.7	:COUNter Commands	81
3.7.1	:COUNter:CURRent?	81
3.7.2	:COUNter:ENABle	82
3.7.3	:COUNter:SOURce	82
3.7.4	:COUNter:MODE	83
3.7.5	:COUNter:NDIGits	84
3.7.6	:COUNter:TOTALize:ENABle	84
3.7.7	:COUNter:TOTALize:CLEar	85
3.8	:CURSor Commands	85
3.8.1	:CURSor:MODE	87
3.8.2	:CURSor:MEASure:INDicator	88
3.8.3	:CURSor:MANual	89
3.8.3.1	:CURSor:MANual:TYPE	89
3.8.3.2	:CURSor:MANual:SOURce	89
3.8.3.3	:CURSor:MANual:CAX	90
3.8.3.4	:CURSor:MANual:CAY	91
3.8.3.5	:CURSor:MANual:CBX	91
3.8.3.6	:CURSor:MANual:CBY	92
3.8.3.7	:CURSor:MANual:AXValue?	93
3.8.3.8	:CURSor:MANual:AYValue?	93
3.8.3.9	:CURSor:MANual:BXValue?	94
3.8.3.10	:CURSor:MANual:BYValue?	94
3.8.3.11	:CURSor:MANual:XDELta?	95
3.8.3.12	:CURSor:MANual:IXDELta?	95
3.8.3.13	:CURSor:MANual:YDELta?	96
3.8.4	:CURSor:TRACk	96
3.8.4.1	:CURSor:TRACk:SOURce1	96
3.8.4.2	:CURSor:TRACk:SOURce2	97
3.8.4.3	:CURSor:TRACk:CAX	98
3.8.4.4	:CURSor:TRACk:CBX	98

3.8.4.5	:CURSor:TRACk:CAY	99
3.8.4.6	:CURSor:TRACk:CBY	100
3.8.4.7	:CURSor:TRACk:AXValue?	100
3.8.4.8	:CURSor:TRACk:AYValue?	101
3.8.4.9	:CURSor:TRACk:BXValue?	101
3.8.4.10	:CURSor:TRACk:BYValue?	102
3.8.4.11	:CURSor:TRACk:XDELta?	102
3.8.4.12	:CURSor:TRACk:YDELta?	103
3.8.4.13	:CURSor:TRACk:IXDelta?	103
3.8.4.14	:CURSor:TRACk:MODE	104
3.8.5	:CURSor:XY	104
3.8.5.1	:CURSor:XY:AX	104
3.8.5.2	:CURSor:XY:BX	105
3.8.5.3	:CURSor:XY:AY	106
3.8.5.4	:CURSor:XY:BY	106
3.8.5.5	:CURSor:XY:AXValue?	107
3.8.5.6	:CURSor:XY:AYValue?	107
3.8.5.7	:CURSor:XY:BXValue?	108
3.8.5.8	:CURSor:XY:BYValue?	108
3.8.5.9	:CURSor:XY:XDELta?	108
3.8.5.10	:CURSor:XY:YDELta?	109
3.9	:DISPlay Commands	109
3.9.1	:DISPlay:CLEAr	110
3.9.2	:DISPlay:TYPE	110
3.9.3	:DISPlay:GRADing:TIME	111
3.9.4	:DISPlay:WBRightness	112
3.9.5	:DISPlay:GRID	112
3.9.6	:DISPlay:GBRightness	113
3.9.7	:DISPlay:DATA?	113
3.9.8	:DISPlay:RULers	114
3.9.9	:DISPlay:COLor	115
3.9.10	:DISPlay:WHOLd	115
3.10	:DVM Commands	116
3.10.1	:DVM:CURRent?	116
3.10.2	:DVM:ENABLE	116
3.10.3	:DVM:SOURce	117
3.10.4	:DVM:MODE	118

3.11	:HISTogram Commands	118
3.11.1	:HISTogram:ENABle	119
3.11.2	:HISTogram:TYPE	120
3.11.3	:HISTogram:SOURce	120
3.11.4	:HISTogram:HEIGHt	121
3.11.5	:HISTogram:RANGE:left	121
3.11.6	:HISTogram:RANGE:RIGHT	122
3.11.7	:HISTogram:RANGE:TOP	123
3.11.8	:HISTogram:RANGE:BOTTom	124
3.11.9	:HISTogram:STATistics:RESult?	125
3.12	IEEE488.2 Common Commands	125
3.12.1	*IDN?	127
3.12.2	*RST	128
3.12.3	*CLS	128
3.12.4	*ESE	128
3.12.5	*ESR?	129
3.12.6	*OPC	130
3.12.7	*RCL	130
3.12.8	*SAV	131
3.12.9	*SRE	131
3.12.10	*STB?	132
3.12.11	*WAI	132
3.12.12	*TST?	133
3.13	:LA Commands	134
3.13.1	:LA:ENABle	134
3.13.2	:LA:ACTive	134
3.13.3	:LA:AUTosort	135
3.13.4	:LA:DELeTe	136
3.13.5	:LA:DIGital:ENABle	136
3.13.6	:LA:DIGital:LABel	137
3.13.7	:LA:POD<n>:DISPlay	138
3.13.8	:LA:POD<n>:THReshold	138
3.13.9	:LA:SIZE	139
3.14	:LAN Commands	140
3.14.1	:LAN:DHCP	140
3.14.2	:LAN:AUTOip	141
3.14.3	:LAN:GATeway	141

3.14.4	:LAN:DNS	142
3.14.5	:LAN:MAC?	143
3.14.6	:LAN:DSErver?	143
3.14.7	:LAN:MANual	144
3.14.8	:LAN:IPADdress	144
3.14.9	:LAN:SMASk	145
3.14.10	:LAN:STATus?	146
3.14.11	:LAN:VISA?	146
3.14.12	:LAN:MDNS	147
3.14.13	:LAN:HOST:NAME	148
3.14.14	:LAN:DESCription	148
3.14.15	:LAN:APPLy	149
3.15	:MASK Commands	149
3.15.1	:MASK:ENABLE	149
3.15.2	:MASK:SOURce	150
3.15.3	:MASK:OPERate	151
3.15.4	:MASK:X	151
3.15.5	:MASK:Y	152
3.15.6	:MASK:CREate	153
3.15.7	:MASK:RESet	153
3.15.8	:MASK:FAILed?	154
3.15.9	:MASK:PASSed?	154
3.15.10	:MASK:TOTal?	155
3.15.11	:MASK:OUTPut:ENABLE	155
3.15.12	:MASK:OUTPut:EVENT	156
3.15.13	:MASK:OUTPut:TIME	156
3.16	:MATH<n> Commands	157
3.16.1	:MATH<n>:DISPlay	160
3.16.2	:MATH<n>:OPERator	161
3.16.3	:MATH<n>:SOURce1	161
3.16.4	:MATH<n>:SOURce2	163
3.16.5	:MATH<n>:LSourcE1	164
3.16.6	:MATH<n>:LSourcE2	164
3.16.7	:MATH<n>:SCALe	165
3.16.8	:MATH<n>:OFFSet	166
3.16.9	:MATH<n>:INVert	167
3.16.10	:MATH<n>:RESet	167

3.16.11	:MATH<n>:GRID	168
3.16.12	:MATH<n>:EXPand	168
3.16.13	:MATH<n>:WAVetype	169
3.16.14	:MATH<n>:FFT:SOURce	170
3.16.15	:MATH<n>:FFT:WINDow	171
3.16.16	:MATH<n>:FFT:UNIT	171
3.16.17	:MATH<n>:FFT:SCALE	172
3.16.18	:MATH<n>:FFT:OFFSet	173
3.16.19	:MATH<n>:FFT:HSCale	174
3.16.20	:MATH<n>:FFT:HCENter	174
3.16.21	:MATH<n>:FFT:FREQuency:STARt	175
3.16.22	:MATH<n>:FFT:FREQuency:END	176
3.16.23	:MATH<n>:FFT:SEARch:ENABle	176
3.16.24	:MATH<n>:FFT:SEARch:NUM	177
3.16.25	:MATH<n>:FFT:SEARch:THReshold	178
3.16.26	:MATH<n>:FFT:SEARch:EXCurSION	178
3.16.27	:MATH<n>:FFT:SEARch:ORDer	179
3.16.28	:MATH<n>:FFT:SEARch:RES?	179
3.16.29	:MATH<n>:FILTer:TYPE	180
3.16.30	:MATH<n>:FILTer:W1	181
3.16.31	:MATH<n>:FILTer:W2	182
3.16.32	:MATH<n>:SENSitivity	183
3.16.33	:MATH<n>:DISTance	184
3.16.34	:MATH<n>:THReshold1	184
3.16.35	:MATH<n>:THReshold2	185
3.16.36	:MATH<n>:THReshold3	186
3.16.37	:MATH<n>:THReshold4	187
3.16.38	:MATH<n>:WINDow:TITLe?	188
3.16.39	:MATH<n>:LABel:SHOW	188
3.17	:MEASure Commands	189
3.17.1	:MEASure:SOURce	195
3.17.2	:MEASure:ITEM	196
3.17.3	:MEASure:CLEar	197
3.17.4	:MEASure:AMSource	198
3.17.5	:MEASure:STATistic:COUNt	198
3.17.6	:MEASure:STATistic:DISPlay	199
3.17.7	:MEASure:STATistic:RESet	200

3.17.8	:MEASure:STATistic:ITEM	200
3.17.9	:MEASure:SETup:MAX	202
3.17.10	:MEASure:SETup:MID	203
3.17.11	:MEASure:SETup:MIN	204
3.17.12	:MEASure:SETup:PSA	204
3.17.13	:MEASure:SETup:PSB	205
3.17.14	:MEASure:SETup:DSA	206
3.17.15	:MEASure:SETup:DSB	207
3.17.16	:MEASure:THReshold:SOURce	207
3.17.17	:MEASure:THReshold:TYPE	208
3.17.18	:MEASure:THReshold:DEFault	209
3.17.19	:MEASure:AREA	209
3.17.20	:MEASure:INDicator	210
3.17.21	:MEASure:COUNter:ENABle	210
3.17.22	:MEASure:COUNter:SOURce	211
3.17.23	:MEASure:COUNter:VALue?	212
3.17.24	:MEASure:AMP:TYPE	212
3.17.25	:MEASure:AMP:MANual:TOP	213
3.17.26	:MEASure:AMP:MANual:BASE	213
3.17.27	:MEASure:CATegory	214
3.18	:QUICK Command	215
3.18.1	:QUICK:OPERation	215
3.19	:RECORD Commands	216
3.19.1	:RECORD:WRECORD:ENABle	216
3.19.2	:RECORD:ENABle	216
3.19.3	:RECORD:WRECORD:OPERate	217
3.19.4	:RECORD:STARt	218
3.19.5	:RECORD:WRECORD:FRAMES	218
3.19.6	:RECORD:FRAMES	219
3.19.7	:RECORD:WRECORD:FRAMES:MAX	219
3.19.8	:RECORD:WRECORD: FMAX?	220
3.19.9	:RECORD:WRECORD:FINTErval	220
3.19.10	:RECORD:WRECORD:PRoMpt	221
3.19.11	:RECORD:WREPlay:FCURrent	221
3.19.12	:RECORD:CURRent	222
3.19.13	:RECORD:WREPlay:FCURrent:TIME?	223
3.19.14	:RECORD:WREPlay:FStArt	223

3.19.15	:RECORD:WREPLAY:FEND	224
3.19.16	:RECORD:WREPLAY:FMAX?	224
3.19.17	:RECORD:WREPLAY:FINTEVAL	225
3.19.18	:RECORD:WREPLAY:MODE	225
3.19.19	:RECORD:WREPLAY:DIRECTION	226
3.19.20	:RECORD:WREPLAY:OPERATE	227
3.19.21	:RECORD:PLAY	227
3.19.22	:RECORD:WREPLAY:BACK	228
3.19.23	:RECORD:WREPLAY:NEXT	228
3.19.24	:RECORD:WREPLAY:PLAY	229
3.20	:REFERENCE Commands	229
3.20.1	:REFERENCE:SOURCE	229
3.20.2	:REFERENCE:VSCALE	230
3.20.3	:REFERENCE:VOFFSET	231
3.20.4	:REFERENCE:RESET	231
3.20.5	:REFERENCE:CURRENT	232
3.20.6	:REFERENCE:SAVE	232
3.20.7	:REFERENCE:COLOR	233
3.20.8	:REFERENCE:LABEL:ENABLE	234
3.20.9	:REFERENCE:LABEL:CONTENT	234
3.21	:SAVE Commands	235
3.21.1	:SAVE:IMAGE:INVERT	235
3.21.2	:SAVE:IMAGE:COLOR	236
3.21.3	:SAVE:IMAGE:FORMAT	236
3.21.4	:SAVE:IMAGE:HEADER	237
3.21.5	:SAVE:IMAGE:DATA?	237
3.21.6	:SAVE:IMAGE	238
3.21.7	:SAVE:SETUP	239
3.21.8	:SAVE:WAVEFORM	240
3.21.9	:SAVE:MEMORY:WAVEFORM	241
3.21.10	:SAVE:STATUS?	241
3.21.11	:SAVE:OVERLAP	242
3.21.12	:SAVE:PREFIX	242
3.21.13	:LOAD:SETUP	243
3.22	:SEARCH Commands	244
3.22.1	:SEARCH:COUNT?	244
3.22.2	:SEARCH:STATE	244

3.22.3	:SEARch:MODE	245
3.22.4	:SEARch:EVENT	245
3.22.5	:SEARch:VALue?	246
3.22.6	:SEARch:EDGE:SLOPe	246
3.22.7	:SEARch:EDGE:SOURce	247
3.22.8	:SEARch:EDGE:THReshold	248
3.22.9	:SEARch:PULSe:POLarity	248
3.22.10	:SEARch:PULSe:QUALifier	249
3.22.11	:SEARch:PULSe:SOURce	250
3.22.12	:SEARch:PULSe:UWIDth	250
3.22.13	:SEARch:PULSe:LWIDth	251
3.22.14	:SEARch:PULSe:THReshold	251
3.23	:NAVigate Commands	252
3.23.1	:NAVigate:ENABLE	252
3.23.2	:NAVigate:MODE	253
3.23.3	:NAVigate:TIME:SPEEd	253
3.23.4	:NAVigate:TIME:PLAY	254
3.23.5	:NAVigate:TIME:END	255
3.23.6	:NAVigate:TIME:STARt	255
3.23.7	:NAVigate:TIME:NEXT	256
3.23.8	:NAVigate:TIME:BACK	256
3.23.9	:NAVigate:SEARch:END	257
3.23.10	:NAVigate:SEARch:STARt	257
3.23.11	:NAVigate:SEARch:NEXT	257
3.23.12	:NAVigate:SEARch:BACK	258
3.23.13	:NAVigate:FRAMe:DISPlay:MODE	258
3.23.14	:NAVigate:FRAMe:END:FRAMe	260
3.23.15	:NAVigate:FRAMe:STARt:FRAMe	260
3.23.16	:NAVigate:FRAMe:END	261
3.23.17	:NAVigate:FRAMe:STARt	261
3.23.18	:NAVigate:FRAMe:NEXT	262
3.23.19	:NAVigate:FRAMe:BACK	262
3.23.20	:NAVigate:FRAMe:PLAY	263
3.24	:SYSTem Commands	263
3.24.1	:SYSTem:AOUTput	264
3.24.2	:SYSTem:BEEPer	264
3.24.3	:SYSTem:ERRor[:NEXT]?	265

3.24.4	:SYSTem:PON	265
3.24.5	:SYSTem:PStatus	266
3.24.6	:SYSTem:RAMount?	267
3.24.7	:SYSTem:RESet	267
3.24.8	:SYSTem:SEtUp	267
3.24.9	:SYSTem:LOCKed	268
3.24.10	:SYSTem:MODules?	269
3.24.11	:SYSTem:AUToscale	269
3.24.12	:SYSTem:GAMount?	270
3.24.13	:SYSTem:VERSion?	271
3.24.14	:SYSTem:DGStatus?	271
3.24.15	:SYSTem:KEYBOARDCheck?	272
3.25	:SOURce Commands	272
3.25.1	:SOURce:OUTPut:STATe	272
3.25.2	:SOURce:FUNcTion	273
3.25.3	:SOURce:FREQuency	273
3.25.4	:SOURce:PHASe	274
3.25.5	:SOURce:FUNcTion:RAMP:SYMMetry	275
3.25.6	:SOURce:FUNcTion:SQUare:DUYT	276
3.25.7	:SOURce:VOLTagE:AMPLitude	276
3.25.8	:SOURce:VOLTagE:OFFSet	277
3.25.9	:SOURce:MOD:STATe	278
3.25.10	:SOURce:MOD:TYPe	278
3.25.11	:SOURce:MOD:AM:DEPTH	279
3.25.12	:SOURce:MOD:AM:INTernal:FREQuency	280
3.25.13	:SOURce:MOD:AM:INTernal:FUNcTion	280
3.25.14	:SOURce:MOD:FM:DEViation	281
3.25.15	:SOURce:MOD:FM:INTernal:FREQuency	282
3.25.16	:SOURce:MOD:FM:INTernal:FUNcTion	283
3.25.17	:SOURce:MOD:PM:DEViation	283
3.25.18	:SOURce:MOD:PM:INTernal:FREQuency	284
3.25.19	:SOURce:MOD:PM:INTernal:FUNcTion	285
3.26	:TIMebase Commands	285
3.26.1	:TIMebase:DELay:ENABle	286
3.26.2	:TIMebase:DELay:OFFSet	287
3.26.3	:TIMebase:DELay:SCALE	288
3.26.4	:TIMebase[:MAIN][:OFFSet]	288

3.26.5	:TIMebase[:MAIN]:SCALe	289
3.26.6	:TIMebase:MODE	290
3.26.7	:TIMebase:HREFerence:MODE	291
3.26.8	:TIMebase:HREFerence:POSition	292
3.26.9	:TIMebase:VERNier	292
3.26.10	:TIMebase:HOTKeys	293
3.26.11	:TIMebase:ROLL	293
3.26.12	:TIMebase:XY:ENABLE	294
3.26.13	:TIMebase:XY:X	295
3.26.14	:TIMebase:XY:Y	295
3.26.15	:TIMebase:XY:Z	296
3.26.16	:TIMebase:XY:GRID	296
3.27	:TRIGger Commands	297
3.27.1	:TRIGger:MODE	297
3.27.2	:TRIGger:COUPling	298
3.27.3	:TRIGger:STATus?	299
3.27.4	:TRIGger:SWEp	299
3.27.5	:TRIGger:HOLDoff	300
3.27.6	:TRIGger:NREJect	301
3.27.7	:TRIGger:POSition?	301
3.27.8	:TRIGger:EDGE	302
3.27.8.1	:TRIGger:EDGE:SOURce	302
3.27.8.2	:TRIGger:EDGE:SLOPe	303
3.27.8.3	:TRIGger:EDGE:LEVel	303
3.27.9	:TRIGger:PULSe	304
3.27.9.1	:TRIGger:PULSe:SOURce	304
3.27.9.2	:TRIGger:PULSe:POLarity	305
3.27.9.3	:TRIGger:PULSe:WHEN	306
3.27.9.4	:TRIGger:PULSe:UWIDth	306
3.27.9.5	:TRIGger:PULSe:LWIDth	307
3.27.9.6	:TRIGger:PULSe:LEVel	308
3.27.10	:TRIGger:SLOPe	308
3.27.10.1	:TRIGger:SLOPe:SOURce	309
3.27.10.2	:TRIGger:SLOPe:POLarity	309
3.27.10.3	:TRIGger:SLOPe:WHEN	310
3.27.10.4	:TRIGger:SLOPe:TUPPer	311
3.27.10.5	:TRIGger:SLOPe:TLOWer	311

3.27.10.6	:TRIGger:SLOPe:WINDow	312
3.27.10.7	:TRIGger:SLOPe:ALEVel	313
3.27.10.8	:TRIGger:SLOPe:BLEVel	313
3.27.11	:TRIGger:VIDeo	314
3.27.11.1	:TRIGger:VIDeo:SOURce	314
3.27.11.2	:TRIGger:VIDeo:POLarity	315
3.27.11.3	:TRIGger:VIDeo:MODE	315
3.27.11.4	:TRIGger:VIDeo:LINE	316
3.27.11.5	:TRIGger:VIDeo:STANdard	317
3.27.11.6	:TRIGger:VIDeo:LEVel	318
3.27.12	:TRIGger:PATtern	319
3.27.12.1	:TRIGger:PATtern:PATtern	319
3.27.12.2	:TRIGger:PATtern:SOURce	321
3.27.12.3	:TRIGger:PATtern:LEVel	321
3.27.13	:TRIGger:DURation	322
3.27.13.1	:TRIGger:DURation:SOURce	323
3.27.13.2	:TRIGger:DURation:TYPE	324
3.27.13.3	:TRIGger:DURation:WHEN	325
3.27.13.4	:TRIGger:DURation:TUPPer	325
3.27.13.5	:TRIGger:DURation:TLOWer	326
3.27.13.6	:TRIGger:DURation:LEVel	327
3.27.14	:TRIGger:TIMeout	328
3.27.14.1	:TRIGger:TIMeout:SOURce	328
3.27.14.2	:TRIGger:TIMeout:SLOPe	329
3.27.14.3	:TRIGger:TIMeout:TIME	330
3.27.14.4	:TRIGger:TIMeout:LEVel	330
3.27.15	:TRIGger:RUNT	331
3.27.15.1	:TRIGger:RUNT:SOURce	331
3.27.15.2	:TRIGger:RUNT:POLarity	332
3.27.15.3	:TRIGger:RUNT:WHEN	332
3.27.15.4	:TRIGger:RUNT:WUPPer	333
3.27.15.5	:TRIGger:RUNT:WLOWer	334
3.27.15.6	:TRIGger:RUNT:ALEVel	335
3.27.15.7	:TRIGger:RUNT:BLEVel	335
3.27.16	:TRIGger:WINDows	336
3.27.16.1	:TRIGger:WINDows:SOURce	336
3.27.16.2	:TRIGger:WINDows:SLOPe	337

3.27.16.3	:TRIGger:WINDows:POSition	337
3.27.16.4	:TRIGger:WINDows:TIME	338
3.27.16.5	:TRIGger:WINDows:ALEVel	339
3.27.16.6	:TRIGger:WINDows:BLEVel	339
3.27.17	:TRIGger:DELaY	340
3.27.17.1	:TRIGger:DELaY:SA	340
3.27.17.2	:TRIGger:DELaY:ASLop	341
3.27.17.3	:TRIGger:DELaY:SB	342
3.27.17.4	:TRIGger:DELaY:BSLop	342
3.27.17.5	:TRIGger:DELaY:TYPE	343
3.27.17.6	:TRIGger:DELaY:TUPPer	344
3.27.17.7	:TRIGger:DELaY:TLOWer	344
3.27.17.8	:TRIGger:DELaY:ALEVel	345
3.27.17.9	:TRIGger:DELaY:BLEVel	346
3.27.18	:TRIGger:SHOLd	346
3.27.18.1	:TRIGger:SHOLd:DSRC	347
3.27.18.2	:TRIGger:SHOLd:CSRC	347
3.27.18.3	:TRIGger:SHOLd:SLOPe	348
3.27.18.4	:TRIGger:SHOLd:PATtern	349
3.27.18.5	:TRIGger:SHOLd:TYPE	349
3.27.18.6	:TRIGger:SHOLd:STIMe	350
3.27.18.7	:TRIGger:SHOLd:HTIMe	351
3.27.18.8	:TRIGger:SHOLd:DLEVel	351
3.27.18.9	:TRIGger:SHOLd:CLEVel	352
3.27.19	:TRIGger:NEDGe	353
3.27.19.1	:TRIGger:NEDGe:SOURce	353
3.27.19.2	:TRIGger:NEDGe:SLOPe	354
3.27.19.3	:TRIGger:NEDGe:IDLE	355
3.27.19.4	:TRIGger:NEDGe:EDGE	355
3.27.19.5	:TRIGger:NEDGe:LEVel	356
3.27.20	:TRIGger:RS232	356
3.27.20.1	:TRIGger:RS232:SOURce	357
3.27.20.2	:TRIGger:RS232:LEVel	357
3.27.20.3	:TRIGger:RS232:POLarity	358
3.27.20.4	:TRIGger:RS232:WHEN	359
3.27.20.5	:TRIGger:RS232:DATA	359
3.27.20.6	:TRIGger:RS232:BAUD	360

3.27.20.7	:TRIGger:RS232:WIDTh	361
3.27.20.8	:TRIGger:RS232:STOP	361
3.27.20.9	:TRIGger:RS232:PARity	362
3.27.21	:TRIGger:IIC	362
3.27.21.1	:TRIGger:IIC:SCL	363
3.27.21.2	:TRIGger:IIC:CLEVel	363
3.27.21.3	:TRIGger:IIC:SDA	364
3.27.21.4	:TRIGger:IIC:DLEVel	365
3.27.21.5	:TRIGger:IIC:WHEN	365
3.27.21.6	:TRIGger:IIC:AWIDth	367
3.27.21.7	:TRIGger:IIC:ADDResS	367
3.27.21.8	:TRIGger:IIC:DIRection	368
3.27.21.9	:TRIGger:IIC:DBYTeS	368
3.27.21.10	:TRIGger:IIC:DATA	369
3.27.21.11	:TRIGger:IIC:CURRbit	370
3.27.21.12	:TRIGger:IIC:CODE	370
3.27.22	:TRIGger:SPI	371
3.27.22.1	:TRIGger:SPI:CLK	371
3.27.22.2	:TRIGger:SPI:SCL	372
3.27.22.3	:TRIGger:SPI:CLEVel	373
3.27.22.4	:TRIGger:SPI:SLOPe	373
3.27.22.5	:TRIGger:SPI:MISO	374
3.27.22.6	:TRIGger:SPI:SDA	374
3.27.22.7	:TRIGger:SPI:DLEVel	375
3.27.22.8	:TRIGger:SPI:WHEN	376
3.27.22.9	:TRIGger:SPI:CS	377
3.27.22.10	:TRIGger:SPI:SLEVel	377
3.27.22.11	:TRIGger:SPI:MODE	378
3.27.22.12	:TRIGger:SPI:TIMEout	379
3.27.22.13	:TRIGger:SPI:WIDTh	379
3.27.22.14	:TRIGger:SPI:DATA	380
3.27.22.15	:TRIGger:SPI:CURRbit	381
3.27.22.16	:TRIGger:SPI:CODE	381
3.27.23	:TRIGger:CAN	382
3.27.23.1	:TRIGger:CAN:BAUD	382
3.27.23.2	:TRIGger:CAN:SOURce	383
3.27.23.3	:TRIGger:CAN:STYPe	383

3.27.23.4	:TRIGger:CAN:WHEN	384
3.27.23.5	:TRIGger:CAN:SPOint	386
3.27.23.6	:TRIGger:CAN:EXTended	386
3.27.23.7	:TRIGger:CAN:DEFine	387
3.27.23.8	:TRIGger:CAN:DWIDTH	388
3.27.23.9	:TRIGger:CAN:DATA	388
3.27.23.10	:TRIGger:CAN:CURRbit	389
3.27.23.11	:TRIGger:CAN:CODE	390
3.27.23.12	:TRIGger:CAN:LEVel	391
3.27.24	:TRIGger:LIN	391
3.27.24.1	:TRIGger:LIN:SOURce	392
3.27.24.2	:TRIGger:LIN:LEVel	392
3.27.24.3	:TRIGger:LIN:STANdard	393
3.27.24.4	:TRIGger:LIN:BAUD	394
3.27.24.5	:TRIGger:LIN:SAMPlepoint	394
3.27.24.6	:TRIGger:LIN:WHEN	395
3.27.24.7	:TRIGger:LIN:ERRor	396
3.27.24.8	:TRIGger:LIN:ID	396
3.27.24.9	:TRIGger:LIN:DATA	397
3.27.24.10	:TRIGger:LIN:CURRbit	397
3.27.24.11	:TRIGger:LIN:CODE	398
3.28	:WAVeform Commands	399
3.28.1	:WAVeform:SOURce	401
3.28.2	:WAVeform:MODE	402
3.28.3	:WAVeform:FORMat	403
3.28.4	:WAVeform:POINts	404
3.28.5	:WAVeform:DATA?	404
3.28.6	:WAVeform:XINCrement?	405
3.28.7	:WAVeform:XORigin?	406
3.28.8	:WAVeform:XREFerence?	406
3.28.9	:WAVeform:YINCrement?	407
3.28.10	:WAVeform:YORigin?	408
3.28.11	:WAVeform:YREFerence?	408
3.28.12	:WAVeform:STARt	409
3.28.13	:WAVeform:STOP	410
3.28.14	:WAVeform:PREamble?	410
4	Application Examples	412

4.1 To Configure Basic Parameters	412
4.2 To Set Measurements	413
4.3 To Read the Waveform	414
5 Programming Examples	416
5.1 Programming Preparations	416
5.2 LabVIEW Programming Example	416
5.3 Visual Basic Programming Example	420
5.4 Visual C++ Programming Example	422

List of Figures

Figure 3.1 Schematic Diagram of Parallel Decoding	34
Figure 3.2 Schematic Diagram of RS232 Serial Bus	40
Figure 3.3 I2C Serial Bus	47
Figure 3.4 SPI Serial Bus	50
Figure 3.5 Sample Position	60
Figure 3.6 Cursors	86
Figure 3.7 Schematic Diagram of RS232 Protocol	357
Figure 3.8 Sequence Diagram of I2C Protocol	363
Figure 3.9 Sequential Chart of SPI Bus	371
Figure 3.10 Data Frame Format of the CAN Bus	382
Figure 3.11 Data Frame Format of the LIN Bus	392
Figure 3.12 Parameter Definitions in NORMAL Mode	399
Figure 3.13 Parameter Definitions in RAW Mode	400

List of Tables

Table 3.128 Table of the Bit Definition of Standard Event Status Register	125
Table 3.129 Table of the Bit Definition of Status Byte Register	126
Table 3.161 Window Function	158
Table 3.162 Logic Operation Results	159

1 Document Overview

This manual introduces how to program and control DHO800 and DHO900 series via the remote interface by using the SCPI (Standard Commands for Programmable Instruments) commands. DHO800 and DHO900 series can communicate with PC via USB and LAN interfaces.



TIP

For the latest version of this manual, download it from RIGOL official website (<http://www.rigol.com>).

Publication Number

PGA39102-1110

Software Version

00.01.00

Software upgrade might change or add product features. Please acquire the latest version of the manual from RIGOL website or contact RIGOL to upgrade the software.

Format Conventions in this Manual

1. Key

The front panel key is denoted by the menu key icon. For example,  indicates the "Default" key.

2. Menu

The menu item is denoted by the format of "Menu Name (Bold) + Character Shading" in the manual. For example, **Setup** indicates the "Setup" sub-menu under the "Utility" function menu. You can click or tap **Setup** to access the "Setup" menu.

3. Operation Procedures

The next step of the operation is denoted by ">" in the manual. For example, 

> **Storage** indicates first clicking or tapping  and then clicking or tapping **Storage**.

4. Connector

The front/rear panel connector is denoted by "Brackets + Connector Name (Bold)", for example, [**AUX OUT**].

Content Conventions in this Manual

DHO800 series digital oscilloscope includes the following models. Four-channel models and two-channel models share the same operation method. Unless otherwise

specified, this manual takes the four-channel model DHO814 as an example to illustrate the operation methods of DHO800 series oscilloscope.

Model	Max. Analog Bandwidth	No. of Analog Channels
DHO802	70 MHz	2+EXT
DHO804	70 MHz	4
DHO812	100 MHz	2+EXT
DHO814	100 MHz	4

DHO900 series digital oscilloscope includes the following models. Unless otherwise specified, this manual takes DHO924S as an example to illustrate the operation methods of DHO900 series.

Model	Max. Analog Bandwidth	No. of Analog Channels
DHO914	125 MHz	4
DHO914S	125 MHz	4
DHO924	250 MHz	4
DHO924S	250 MHz	4

2 Programming Overview

2.1 SCPI Command Overview

SCPI (Standard Commands for Programmable Instruments) is a standardized instrument programming language that is built upon the existing standard IEEE 488.1 and IEEE 488.2 and conforms to various standards, such as the floating point operation rule in IEEE 754 standard, ISO 646 7-bit coded character set for information interchange (equivalent to ASCII programming). The SCPI commands provide a hierarchical tree structure, and consist of multiple subsystems. Each command subsystem consists of one root keyword and one or more sub-keywords.

Syntax

The command line usually starts with a colon; the keywords are separated by colons, and following the keywords are the parameter settings available. The command ending with a quotation mark indicates querying a certain function and returns the query results. The keywords of the command and the first parameter are separated by a space.

For example,

```
:ACQuire:TYPE <type>
```

```
:ACQuire:TYPE?
```

ACQuire is the root keyword of the command, **TYPE** is the second-level keyword. The command line starts with a colon ":", and different levels of keywords are also separated by colons. *<type>* indicates a settable parameter. The command ending with a quotation mark "?" indicates querying a certain function. The command keywords **:ACQuire:TYPE** and the parameter *<type>* are separated by a space.

In some commands with parameters, "," is often used to separate multiple parameters. For example,

```
:SYSTem:DATE <year>,<month>,<day>
```

Symbol Description

The following symbols are not sent with the commands.

1. Braces { }

The contents in the braces can contain one or multiple parameters. These parameters can be omitted or used for several times. Parameters are usually separated by the vertical bar "|". When using the command, you must select one of the parameters.

2. Vertical Bar |

The vertical bar is used to separate multiple parameters. When using the command, you must select one of the parameters.

3. Square Brackets []

The contents in the square brackets can be omitted.

4. Angle Brackets < >

The parameter enclosed in the angle brackets must be replaced by an effective value.

Parameter Type

1. Bool

The parameter can be set to ON, OFF, 1, or 0. For example,

```
:SYSTem:BEEPer <bool>
```

```
:SYSTem:BEEPer?
```

Wherein, <bool> can be set to {{1|ON}}{0|OFF}}. The query returns 1 or 0.

2. Discrete

The parameter can be any of the values listed. For example,

```
:SYSTem:PSTatus <sat>
```

```
:SYSTem:PSTatus?
```

Wherein,

- <sat> can be set to DEFault|OPEN.
- The query returns an abbreviated form: DEF or OPEN.

3. Integer

Unless otherwise specified, the parameter can be any integer (NR1 format) within the effective value range.



CAUTION

Do not set the parameter to a decimal, otherwise, errors will occur.

For example,

```
:DISPlay:GBrightness <brightness>
```

```
:DISPlay:GBrightness?
```

Wherein, <brightness> can be set to an integer ranging from 1 to 100. The query returns an integer ranging from 1 to 100.

4. Real

The parameter can be any real number within the effective value range, and this command accepts parameter input in decimal (NR2 format) and scientific notation (NR3 format). For example,

```
:TRIGger:TIMEout:TIME <time>
```

```
:TRIGger:TIMEout:TIME?
```

Wherein, <time> can be set to any real number ranging from 1.6E-8 (16 ns) to 1E+1 (10 s). The query returns a real number in scientific notation.

5. ASCII String

The parameter can be the combinations of ASCII characters. For example,

```
:LAN:GATeway <string>
```

Wherein, <string> can be set to

```
192.168.1.1
```

Command Abbreviation

The keywords of all the commands are case-insensitive. They can all be in upper case or in lower case. If an abbreviation is used, you must input all the capital letters in the command. For example,

```
:DISPlay:GBRrightness?
```

can be abbreviated as

```
:DISP:GBR?
```

2.2 Remote Control

This instrument can be connected to the PC via the USB, or LAN interface to set up communication and realize remote control through the PC. The remote control can be realized by using SCPI (Standard Commands for Programmable Instruments) commands.

PC Software

Users usually need to use the PC software to send commands to control the instrument remotely. RIGOL Ultra Sigma is recommended. When the instrument is connected to the PC via the USB, or LAN interface, the Ultra Sigma software can search for instrument resources and enable command interaction.

Log in to the RIGOL official website. Click **Support** and select **Soft/Firmware** to obtain the Ultra Sigma software package and help documentation.

Web Control

When the instrument is connected to the PC via the LAN interface, you can use Web Control to send SCPI commands from the PC to the instrument.

The operation procedures are as follows:

1. Obtain the instrument's IP address and input it in the browser address bar to log in to the Web Control page.
2. After you enter the Web Control interface, click the "SCPI Panel Control" button to enter the SCPI Command interface.
3. Input the specified SCPI command and then click **Send & Read** to send the command. The operation process and the returned value will be displayed in the current interface.

2.2.1 Remote Control via USB

1. Connect the device

Use the USB cable to connect the rear-panel USB DEVICE interface of the instrument to the USB HOST interface of the PC.

2. Search for the device resource

Start up Ultra Sigma and the software will automatically search for the resource currently connected to the PC via the USB interface. You can also click **USB-TMC** to search for the resource.

3. View the device resource

The resources found will appear under the "RIGOL Online Resource" directory, and the model number and USB interface information of the instrument will also be displayed.

4. Control the instrument remotely

Right-click the device resource name and select "SCPI Panel Control" to open the remotely command control panel. Then you can send commands and read data through the panel. For details about the SCPI commands and programming, refer to the Programming Guide of this instrument.

2.2.2 Remote Control via LAN

1. Connect the device

Use the network cable to connect the instrument to your local area network (LAN).

2. Configure network parameters

Configure the network parameters of the instrument in **Utility>IO** menu.

Click or tap the Notification Area at the lower-right corner of the screen, then the **Utility** menu is displayed. Click or tap **IO**, and then click or tap the input field of **GPIB** to input the GPIB address with the pop-up numeric keypad.

3. Search for Search device resource

Start up Ultra Sigma and click **LAN** to open the panel as shown in the figure below. Click **Search** and the software searches for the instrument resources currently connected to the LAN and the resources found are displayed at the right section of the window as shown in the figure below. Click **OK** to add it.



Besides, you can input the IP address of the instrument manually into the text field under "Manual Input LAN Instrument IP", then click **TEST**. If the instrument passes the test, click **Add** to add the instrument to the LAN instrument resource list in the right section; if the instrument fails the test, please check whether the IP address that you input is correct, or use the auto search method to add the instrument resource.

4. View the device resource

The resources found will appear under the "RIGOL Online Resource" directory.

5. Control the instrument remotely

Right-click the device resource name and select "SCPI Panel Control" to open the remotely command control panel. Then you can send commands and read data through the panel.

6. Load LXI webpage

As this instrument conforms to LXI CORE 2011 DEVICE standards, you can load LXI web page through Ultra Sigma (right-click the instrument resource name and select "LXI-Web"). Various important information about the instrument (including the model, manufacturer, serial number, description, MAC address, and IP address) will be displayed on the web page. You can also directly input the IP address of the instrument in the address bar of the PC browser to load the LXI web page.

2.3 Sequential Commands and Overlapped Commands

IEEE488.2 defines the differentiation between the Sequential commands and the Overlapped commands.

- **Sequential Commands**

Commands that shall be executed in sequence. Before completing the execution of one sequential command, another command shall not be executed. A command is a Sequential Command when Execution Control waits for the resulting device action to complete before it initiates the next device action.

The following figure shows the example of the sequence order for the sequential command.

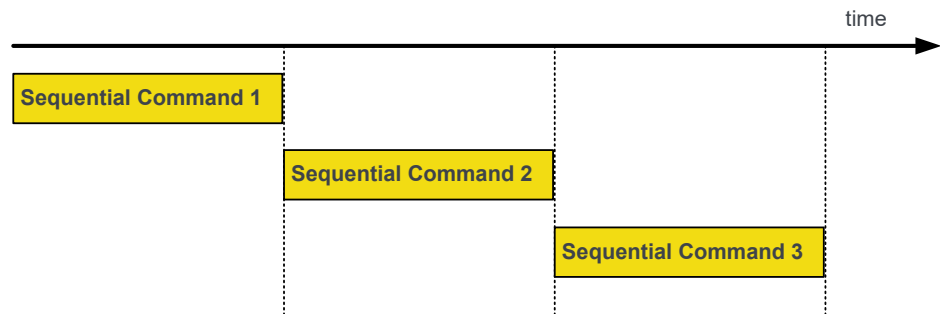

- **Overlapped Commands**

Commands that can be executed with several other commands being executed in parallel. During the execution process, several commands may be overlapped with each other. An overlapped command is a command that allows execution of subsequent commands while the device operations initiated by that overlapped command are still in progress.

The following figure shows the example of the sequence order for the overlapped command.

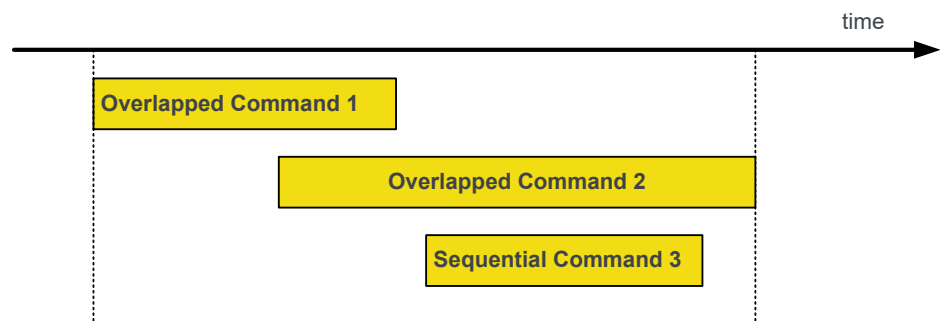

To ensure that the instrument functions can be synchronized through the commands executed in the specified order and query the command execution status, IEEE488.2

defines three general commands (**WAI*, **OPC*, and **OPC?*) to check the operation complete (OPC) function of the instrument.

- ***WAI:** The **WAI* command shall prevent the instrument from executing further commands or queries until all the received commands have been completely executed. The **WAI* command will not operate on the register.

If you want the overlapped commands to be executed in sequence just like the sequential commands, you can send the **WAI* command before or after the specified overlapped command. For example,

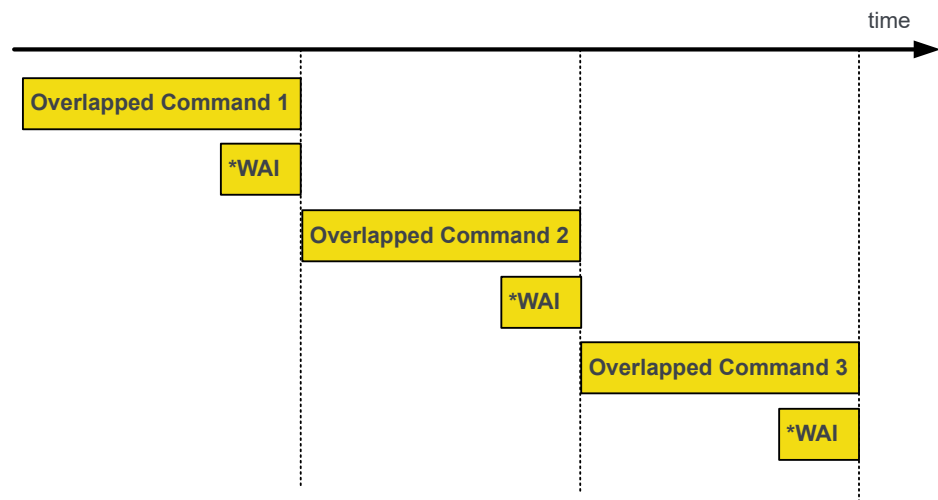

- ***OPC:** Upon receiving the **OPC* command, the instrument will wait until all the previously received commands have been completely executed. Meanwhile, it will set Bit 0 in the *Standard Event Register* to 1, and then execute the following commands.
- ***OPC?:** Upon receiving the **OPC?* Command, the instrument will query whether all the previous received commands have been completely executed. If completed, the query returns 1; if not, it will wait until all the pending operations have been completed and then returns 1. The **OPC?* command shall not operate on the register.

If you want to query the execution status of a series of commands and control the execution sequence of the command, send the **OPC?* Command. For example,

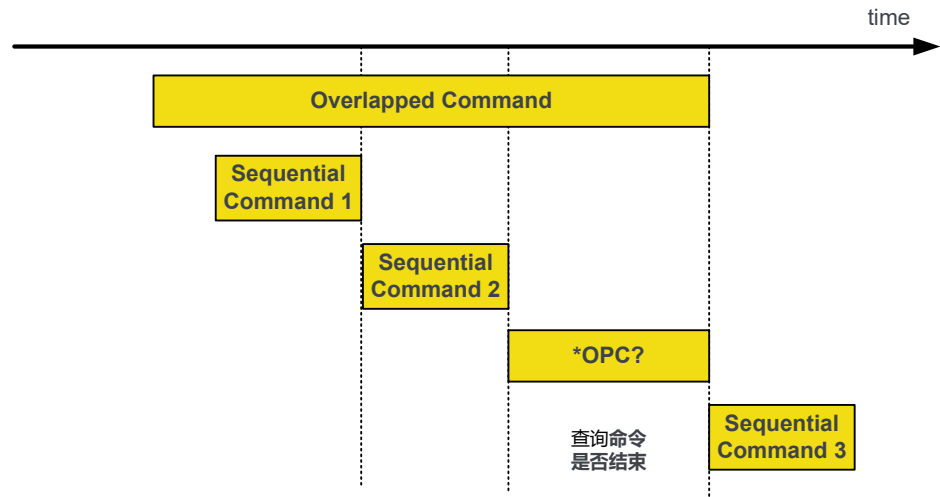

The following table lists the overlapped commands that support the Operation Complete (OPC) function. While using the overlapped commands, pay attention to the execution order of the command to avoid causing any abnormalities to the results.

Command	Constraint Condition
<i>*RST</i>	-

2.4 Compatible Command

The compatible command in this manual refers to the backward compatible command. After the command has been updated to the new version, the old one can still be used and executed.

The following table lists the backward compatible command and its current new command.

Current Command	Compatible Command
<i>:ACquire:MDEPth</i>	<i>:ACquire:MEMDepth?</i>
<i>:BUS<n>:SPI:POLarity</i>	<i>:BUS<n>:SPI:MISO:POLarity</i> <i>:BUS<n>:SPI:MOSI:POLarity</i>
<i>:RECORD:WRECORD:ENABLE</i>	<i>:RECORD:ENABLE</i>
<i>:RECORD:WRECORD:OPERate</i>	<i>:RECORD:START</i>
<i>:RECORD:WRECORD:FRAMES</i>	<i>:RECORD:FRAMES</i>
<i>:RECORD:WREPlay:FCURRENT</i>	<i>:RECORD:CURRENT</i>
<i>:RECORD:WREPlay:OPERate</i>	<i>:RECORD:PLAY</i>

Current Command	Compatible Command
<i>:TRIGger:SPI:CLK</i>	<i>:TRIGger:SPI:SCL</i>
<i>:TRIGger:SPI:MISO</i>	<i>:TRIGger:SPI:SDA</i>

3 Command System

This chapter introduces the syntax, functions, parameters, and usage of each command. By default, only CH1 is enabled.



NOTE

For the parameter setting command (time, frequency, amplitude, etc.), the digital oscilloscope can only recognize the numbers, unable to recognize the unit sent together with them. The unit of the parameter is a default one. For the default units of various parameters, refer to the descriptions for the specified command.

3.1 Root Commands

Root level commands only have the root keywords, without the next level keywords. They control many of the basic operations of the instrument.

3.1.1 :CLEAr

Syntax

:CLEAr

Description

Clears all the waveforms on the screen.

This command functions the same as the front-panel key .

Parameter

N/A

Remarks

N/A

Return Format

N/A

Example

N/A



3.1.2 :RUN

Syntax

:RUN

Description

The :RUN command starts running the oscilloscope

This command functions the same as clicking or tapping the icon  in the quick operation bar at the upper-right part of the screen; or the  tap the on the front panel.

Parameter

N/A

Remarks

N/A

Return Format

N/A

Example

N/A



3.1.3 :STOP

Syntax

:STOP

Description

The :STOP command stops running the oscilloscope.

This command functions the same as clicking or tapping the icon  in the quick operation bar at the upper-right part of the screen; or the  key on the front panel.

Parameter

N/A

Remarks

N/A

Return Format

N/A

Example

N/A

3.1.4 :SINGle

Syntax

:SINGle

Description

Performs a single trigger. Sets the trigger mode of the oscilloscope to "Single". This command functions the same as sending the *:TRIGger:SWEep SINGle* command.

This command functions the same as the front-panel key  .

Parameter

N/A

Remarks

- In the single trigger mode, the oscilloscope performs a single trigger when the trigger conditions are met and then it stops.
- When the waveform recording function is enabled or the recorded waveforms are played back, this command is invalid.
- For the single trigger, you can use the *:TFORce* command to generate one trigger by force.

Return Format

N/A

Example

N/A

3.1.5 :TFORce

Syntax

:TFORce

Description

Generates a trigger signal forcefully. This command is only applicable to the normal and single trigger modes. Refer to the *:TRIGger:SWEep* command).

This command functions the same as the  key in the trigger control area of the front panel.

Parameter

N/A

Remarks

N/A

Return Format

N/A

Example

N/A

3.2 :AUToset Commands

The **:AUToset** commands are used to perform waveform auto setting operations.

3.2.1 :AUToset

Syntax**:AUToset****Description**

Enables the waveform auto setting function. The oscilloscope will automatically adjust the vertical scale, horizontal time base, and trigger mode according to the input signal to realize optimal waveform display.

This command functions the same as the front-panel key .

Parameter

N/A

Remarks

- When the AUTO function is disabled, this command is invalid. For details, refer to *:SYSTEM:AUToscale*.
- When the pass/fail test is enabled, the AUTO function runs normally, but the pass/fail test function is forced to be disabled.
- When the waveform recording function is enabled, the AUTO function runs normally, but the recording or playing function is forced to be disabled.

Return Format

N/A

Example

N/A

3.2.2 :AUToset:PEAK

Syntax`:AUToset:PEAK <bool>``:AUToset:PEAK?`**Description**

Sets or queries whether the peak-peak priority setting is enabled.

Parameter

Name	Type	Range	Default
<bool>	Bool	{{1 ON}} {{0 OFF}}	1 ON

Remarks

This function is intended for the shifted signal. If there is a large deviation, you can view the signal waveform in priority when you enable the function.

Return Format

The query returns 0 or 1.

Example

```
:AUToset:PEAK OFF /*Disables the peak-peak priority setting.*/
:AUToset:PEAK? /*The query returns 0.*/
```

3.2.3 :AUToset:OPENch

Syntax`:AUToset:OPENch <bool>``:AUToset:OPENch?`**Description**

Sets or queries whether to only test the enabled channel when performing the AUTO operation.

Parameter

Name	Type	Range	Default
<bool>	Bool	{{1 ON}}{0 OFF}}	0 OFF

Remarks

- If you select "0|OFF", the system will test the four analog channels (CH1-CH4) in sequence when performing the AUTO operation. If no signal is found on the channel, then the channel is disabled. If a signal is found on the channel, adjust the channel to an optimal scale to show the signal.
- If you select "1|ON", the system will only test the enabled channels when performing the AUTO operation.

Return Format

The query returns 0 or 1.

Example

```
:AUToset:OPENch ON /*Sets to test only the enabled channel(s) for
AUTO operation.*/
:AUToset:OPENch? /*The query returns 1.*/
```

3.2.4 :AUToset:OVERlap

Syntax

```
:AUToset:OVERlap <bool>
```

```
:AUToset:OVERlap?
```

Description

Sets or queries the waveform display mode.

Parameter

Name	Type	Range	Default
<bool>	Bool	{{1 ON}}{0 OFF}}	1 ON

Remarks

- **1|ON:** enables the waveform overlay display. Waveforms of different channels will be displayed in the same position of the screen.

- **0|OFF:** disables the waveform overlay display. Waveforms of different channels will be displayed on the screen from top to bottom in sequence.

Return Format

The query returns 0 or 1.

Example

```
:AUToset:OVERlap OFF /*Disables the waveform overlay display.*/
:AUToset:OVERlap? /*The query returns 0.*/
```

3.2.5 :AUToset:KEEPcoup

Syntax

```
:AUToset:KEEPcoup <bool>
```

```
:AUToset:KEEPcoup?
```

Description

Sets or queries whether to enable keeping coupling.

Parameter

Name	Type	Range	Default
<bool>	Bool	{{1 ON}}{0 OFF}}	0 OFF

Remarks

- **1|ON:** Enables keeping coupling. When enabled, the system performs auto setting operation. The settings for the channel coupling remain unchanged.
- **0|OFF:** Disables keeping coupling. When disabled, the channel is, by default, DC coupled.

Return Format

The query returns 0 or 1.

Example

```
:AUToset:KEEPcoup ON /*Sets to enable keeping coupling.*/
:AUToset:KEEPcoup? /*The query returns 1.*/
```

3.2.6 :AUToset:LOCK

Syntax

```
:AUToset:LOCK <bool>
```

:AUToset:LOCK?

Description

Sets or queries the on/off status of the AUTO function.

Parameter

Name	Type	Range	Default
<bool>	Bool	{{1 ON}}{0 OFF}}	0 OFF

Remarks

- **1|ON:** locks the AUTO key; disables the AUTO function.
- **0|OFF:** unlocks the AUTO key; enables the AUTO function.

You can also send the *:AUToset:ENable* command to enable or disable the AUTO function.

Return Format

The query returns 0 or 1.

Example

```
:AUToset:LOCK ON /*Locks the AUTO key; disables the AUTO
function.*/
:AUToset:LOCK? /*The query returns 1.*/
```

3.2.7 :AUToset:ENable

Syntax

:AUToset:ENable <bool>

:AUToset:ENable?

Description

Sets or queries whether to enable the AUTO function.

Parameter

Name	Type	Range	Default
<bool>	Bool	{{1 ON}}{0 OFF}}	1 ON

Remarks

- **1|ON:** enables the AUTO function. It functions the same as enabling the front-

panel key .

- **0|OFF:** disables the AUTO function. It functions the same as disabling the front-

panel key .

You can also send the `:AUToset:LOCK` command to enable or disable the AUTO function.

Return Format

The query returns 0 or 1.

Example

```
:AUToset:ENable OFF /*Disables the AUTO function.*/  
:AUToset:ENable? /*The query returns 0.*/
```

3.3 :ACQUIRE Commands

The `:ACQUIRE` commands are used to set the memory depth of the oscilloscope, the acquisition mode, the average times, as well as query the current sample rate.

3.3.1 :ACQUIRE:AVERages

Syntax

```
:ACQUIRE:AVERages <count>
```

```
:ACQUIRE:AVERages?
```

Description

Sets or queries the number of averages in the average acquisition mode.

Parameter

Name	Type	Range	Default
<count>	Integer	2 ⁿ (n is an integer, and its range is from 1 to 16).	2

Remarks

- You can send the `:ACQUIRE:TYPE` command to set the acquisition mode.
- In the average acquisition mode, greater number of averages can lower the noise and increase the vertical resolution; but will also slow the response of the displayed waveform to the waveform changes.
- The number of averages must be in the Nth power of 2. When the value is not in the Nth power of 2, a value that is smaller than the one you input and the closest

to the N power-of-2 increments will be input automatically. For example, if you input 9 with the numeric keypad, the average count will be input 8 automatically.

Return Format

The query returns an integer ranging from 2 to 65536.

Example

```
:ACQUIRE:AVERages 128 /*Sets the average times to 128.*/
:ACQUIRE:AVERages? /*The query returns 128.*/
```

3.3.2 :ACQUIRE:MDEPTH

Syntax

```
:ACQUIRE:MDEPTH <mdep>
```

```
:ACQUIRE:MDEPTH?
```

Description

Sets or queries the memory depth of the oscilloscope (i.g. the number of waveform points that can be stored through the sampling in a single trigger). The default unit is pts.

Parameter

Name	Type	Range	Default
<mdep>	Discrete	{AUTO 1k 10k 100k 1M 10M 25M 50M 1000 10000 100000 1000000 10000000 25000000 50000000 1e3 1e4 1e5 1e6 1e7 2.5e7 5e7}	10k

Remarks

When you select the "Auto" mode, the oscilloscope selects the memory depth automatically according to the current sample rate.

- When only one of the four channels is enabled:
 - For DHO800 series, the available memory depths are AUTO, 1k, 10k, 100k, 1M, 10M, and 25M.
 - For DHO900 series, the available memory depths are AUTO, 1k, 10k, 100k, 1M, 10M, 25M, and 50M.
- When any two of the four channels are enabled:

- For DHO800 series, the available memory depths are AUTO, 1k, 10k, 100k, 1M, and 10M.
- For DHO900 series, the available memory depths are AUTO, 1k, 10k, 100k, 1M, 10M, and 25M.
- When three channels or four channels are enabled (only applicable to four-channel models):
 - For DHO800 series, the available memory depths are AUTO, 1k, 10k, 100k, and 1M.
 - For DHO900 series, the available memory depths are AUTO, 1k, 10k, 100k, 1M, and 10M.

Modifying the memory depth will affect the sample rate. To query the current sample rate, run the `:ACQUIRE:SRATE?` command.

Return Format

The query returns the memory depth in scientific notation.

Example

```
:ACQUIRE:MDEPth 1M /*Sets the memory depth to 1M.*/  
:ACQUIRE:MDEPth? /*The query returns 1.000E+6.*/
```

3.3.3 :ACQUIRE:MEMDepth?

Syntax

```
:ACQUIRE:MEMDepth?
```

Description

Queries the memory depth of the oscilloscope.

Parameter

N/A

Remarks

This command exists for backwards compatibility. Use the command `:ACQUIRE:MDEPth`.

Return Format

The query returns the memory depth in strings.

Example

```
:ACQUIRE:MDEPth? /*The query returns 1.000E+6.*/
```

3.3.4 :ACQUIRE:TYPE**Syntax**

```
:ACQUIRE:TYPE <type>
```

```
:ACQUIRE:TYPE?
```

Description

Sets or queries the acquisition mode of the oscilloscope.

Parameter

Name	Type	Range	Default
<type>	Discrete	{NORMAL PEAK AVERages ULTRa}	NORMAL

Remarks

- **NORMAL:** In this mode, the oscilloscope samples the signal at a specified fixed time interval to rebuild the waveform. For most of the waveforms, using this mode can produce the optimal display effects.
- **AVERages:** In this mode, the oscilloscope averages the waveforms from multiple samples to reduce the random noise of the input signal and improve the vertical resolution. The greater the number of averages, the lower the noise and the higher the vertical resolution. Meanwhile this will slow the response of the displayed waveform to the waveform changes.
- **PEAK:** indicates the peak detection. In this mode, the oscilloscope samples the maximum and minimum value of the signal at the fixed sampling interval to acquire the signal envelope or the narrow pulses that might be lost. In this mode, signal aliasing can be prevented, but the noise displayed would be larger.
- **ULTRa (UltraAcquire):** divides the oscilloscope's memory into segments and fills a memory segment for each individual trigger event. In this mode, it provides a high waveform capture rate and minimizes the dead time between trigger events.

Return Format

The query returns NORM, PEAK, AVER, or ULTR.

Example

```
:ACQUIRE:TYPE AVERages /*Sets the acquisition mode to
AVERages.*/
:ACQUIRE:TYPE? /*The query returns AVER.*/
```

3.3.5 :ACQUIRE:SRATE?**Syntax**

```
:ACQUIRE:SRATE?
```

Description

Queries the current sample rate. The default unit is Sa/s.

Parameter

N/A

Remarks

- Sample rate indicates the frequency of the signal sampling, that is, the number of waveform points sampled per second.
- The sample rate and memory depth will change accordingly in accordance with the horizontal time base. To set the memory depth, send the *:ACQUIRE:MDEPTH* command. To set the horizontal time base, send the *:TIMEBASE:MAINJ:SCALE* command.

Return Format

The query returns the sample rate in scientific notation.

Example

```
:ACQUIRE:SRATE? /*The query returns 1.00000E+6.*/
```

3.3.6 :ACQUIRE:ULTRA:MODE**Syntax**

```
:ACQUIRE:ULTRA:MODE <mode>
```

```
:ACQUIRE:ULTRA:MODE?
```

Description

Sets or queries the display mode of Ultra Acquire.

Parameter

Name	Type	Range	Default
<mode>	Discrete	{ADJacent OVERlay WATERfall PERSpective MOSaic}	-

Remarks

- **ADJacent:** indicates the adjacent display. Waveform segments are shown in adjacent display, with each segment shown next to the previous segment. In this mode, a maximum of 100 frames of waveforms can be displayed on the screen at a time.
- **OVERlay:** indicates the overlay display. All the captured waveform segments are overwritten to display as one single segment of the waveform. In this mode, a maximum of 100 frames of waveforms can be displayed on the screen at a time.
- **WATERfall:** indicates the waterfall display. It displays the captured waveform segments in a cascaded display order. In this mode, a maximum of 100 frames of waveforms can be displayed on the screen at a time.
- **PERSpective:** indicates the perspective display. The waveform segments are displayed in the ladder-like form, with each segment being arranged above another with a certain perspective (angle), moving up like a rising slope. In this mode, a maximum of 100 frames of waveforms can be displayed on the screen at a time.
- **MOSaic:** indicates the mosaic display. The whole waveform view is divided into several blocks, and each waveform segment is displayed in each block in sequence. In this mode, a maximum of 80 frames of waveforms can be displayed on the screen at a time.

Return Format

The query returns ADJ, OVER, WAT, PERS, or MOS.

Example

```
:ACQuire:ULTRa:MODE ADJacent /*Sets the Ultra Acquire display
mode to ADJacent.*/
:ACQuire:ULTRa:MODE? /*The query returns ADJ.*/
```

3.3.7 :ACQUIRE:ULTRa:TIMEout

Syntax

```
:ACQUIRE:ULTRa:TIMEout < tmo>
:ACQUIRE:ULTRa:TIMEout?
```

Description

Sets or queries the timeout value of Ultra Acquire.

Parameter

Name	Type	Range	Default
<tmo>	Real	1 us to 1 s	1.00 ms

Remarks

N/A

Return Format

The query returns a real number in scientific notation.

Example

```
:ACQUIRE:ULTRa:TIMEout 0.1 /*Sets the Ultra Acquire timeout
value to 0.1 s.*/
:ACQUIRE:ULTRa:TIMEout? /*The query returns 1E-1.*/
```

3.3.8 :ACQUIRE:ULTRa:MAXFrame

Syntax

```
:ACQUIRE:ULTRa:MAXFrame < frame>
:ACQUIRE:ULTRa:MAXFrame?
```

Description

Sets or queries the maximum number of frames that can be set for Ultra Acquire sampling mode.

Parameter

Name	Type	Range	Default
<frame>	Integer	1 to the maximum number of frames	-

Remarks

N/A

Return Format

The query returns the maximum number of frames in integer.

Example

```
:ACQUIRE:ULTRa:MAXFrame 100 /*Sets the maximum number of frames
to 100.*/
:ACQUIRE:ULTRa:MAXFrame? /*The query returns 100.*/
```

3.4 :BUS<n> Commands

The **:BUS<n>** commands are used to execute the decoding-related settings and operations.

3.4.1 :BUS<n>:MODE**Syntax**

```
:BUS<n>:MODE <mode>
```

```
:BUS<n>:MODE?
```

Description

Sets or queries the decoding type of the specified decoding bus.

Parameter

Name	Type	Range	Default
<n>	Discrete	{1 2 3 4}	-
<mode>	Discrete	{PARAllel RS232 SPI IIC LIN CAN}	PARAllel

Remarks

Only the DHO900 series supports LIN decodings.

Return Format

The query returns PAR, RS232, SPI, IIC, LIN, or CAN.

Example

```
:BUS1:MODE SPI /*Sets the decoding type to SPI.*/
:BUS1:MODE? /*The query returns SPI.*/
```

3.4.2 :BUS<n>:DISPlay**Syntax**

```
:BUS<n>:DISPlay <bool>
```

```
:BUS<n>:DISPlay?
```

Description

Enables or disables the specified decoding bus; or queries the on/off display status of the specified decoding bus.

Parameter

Name	Type	Range	Default
<n>	Discrete	{1 2 3 4}	-
<bool>	Bool	{{1 ON} {0 OFF}}	0 OFF

Remarks

N/A

Return Format

The query returns 1 or 0.

Example

```
:BUS1:DISPlay ON /*Enables the decoding bus.*/
:BUS1:DISPlay? /*The query returns 1.*/
```

3.4.3 :BUS<n>:FORMat**Syntax**

```
:BUS<n>:FORMat <format>
```

```
:BUS<n>:FORMat?
```

Description

Sets or queries the format of decoding data on the specified decoding bus.

Parameter

Name	Type	Range	Default
<n>	Discrete	{1 2 3 4}	-
<format>	Discrete	{HEX ASCii DEC BIN}	HEX

Remarks

- **Hex:** indicates Hexadecimal;
- **ASCii:** indicates ASCII;
- **DEC:** indicates Decimal;
- **BIN:** indicates Binary.

Return Format

The query returns HEX, ASC, DEC, or BIN.

Example

```
:BUS1:FORMat HEX /*Sets the display format of the bus to HEX.*/
:BUS1:FORMat? /*The query returns HEX.*/
```

3.4.4 :BUS<n>:EVENT**Syntax**

```
:BUS<n>:EVENTt <bool>
```

```
:BUS<n>:EVENTt?
```

Description

Enables or disables the event table of the specified decoding bus; or queries the on/off status of the specified decoding bus event table.

Parameter

Name	Type	Range	Default
<n>	Discrete	{1 2 3 4}	-
<bool>	Bool	{{1 ON}}{0 OFF}}	0 OFF

Remarks

Before using the command, enable the specified decoding bus.

Return Format

The query returns 1 or 0.

Example

```
:BUS1:EVENT ON /*Enables the event table of the specified
decoding bus.*/
:BUS1:EVENTt? /*The query returns 1.*/
```

3.4.5 :BUS<n>:LABEl**Syntax**

```
:BUS<n>:LABEl <bool>
```

```
:BUS<n>:LABEl?
```

Description

Enables or disables the label of the specified decoding bus; or queries the on/off display status of the label of the specified decoding bus.

Parameter

Name	Type	Range	Default
<n>	Discrete	{1 2 3 4}	-
<bool>	Bool	{{1 ON}}{0 OFF}}	1 ON

Remarks

Before using the command, enable the specified decoding bus.

Return Format

The query returns 1 or 0.

Example

```
:BUS1:LABel ON /*Enables the label of the specified decoding bus.*/
:BUS1:LABel? /*The query returns 1.*/
```

3.4.6 :BUS<n>:DATA?**Syntax**

```
:BUS<n>:DATA?
```

Description

Reads the data from the decoding event table.

Parameter

Name	Type	Range	Default
<n>	Discrete	{1 2 3 4}	-

Remarks

N/A

Return Format

The query returns the data in the decoding event table with the following formats.

```
#9000000086PARALLEL
Time,Data,
-2.47us,0,
-2.444us,1,
-1.448us,0,
-446ns,1,
551.6ns,0,
1.554us,1,
```

Wherein, "#9000000086" is the TMC data block header, which is followed by the data in the event table. The 9-digit data following #9 in the data block header indicates the number of bytes of the effective data. "PARALLEL" indicates the decoding type. The

available decoding type can also be RS232, I2C, SPI, LIN, and etc. The data are separated by a comma, and will automatically switch to the next line according to the data information in the decoding list. The data value is related to the numeral system that you have set.



CAUTION

You can save all the data (except TMC data block header and decoding type, e.g. #9000000086PARALLEL) as the "*.csv" file and view the data in the form of a list.

Example

N/A

3.4.7 :BUS<n>:EEXPort

Syntax

```
:BUS<n>:EEXPort <path>
```

Description

Exports the decoding information from the specified decoding bus event table in CSV form.

Parameter

Name	Type	Range	Default
<n>	Discrete	{1 2 3 4}	-
<path>	ASCII String	Refer to <i>Remarks</i>	-

Remarks

- <path> includes the file storage location and the filename with a suffix. If the specified storage location already contains a file with the same filename, the original file will be overwritten.
- When the operating status of the instrument is STOP (set it by sending the *.STOP* command), you can export the time and corresponding decoding data from the current event table.
- This command is valid when the display of the event table is enabled. You can enable the display of the event table by sending the *:BUS<n>:EVENT* command.
- The stored "*.csv" file can be opened and edited in Excel.

Return Format

N/A

Example

```
:BUS1:EEEXPort C:/123.csv /*Exports the decoding information from
the bus event table and saves it to the local Disk C, with the
filename 123.csv.*/*
```

3.4.8 :BUS<n>:POSition**Syntax**

```
:BUS<n>:POSition <pos>
```

```
:BUS<n>:POSition?
```

Description

Sets or queries the vertical position of the bus on the screen.

Parameter

Name	Type	Range	Default
<n>	Discrete	{1 2 3 4}	-
<pos>	Integer	-250 to 250	0

Remarks

N/A

Return Format

The query returns an integer ranging from -250 to 250.

Example

```
:BUS1:POSition 200 /*Sets the vertical position of the bus to
200.*/*
:BUS1:POSition? /*The query returns 200.*/*
```

3.4.9 :BUS<n>:THReshold**Syntax**

```
:BUS<n>:THReshold <value>,<type>
```

```
:BUS<n>:THReshold? <type>
```

Description

Sets or queries the threshold of the specified decoding source on the specified decoding bus.

Parameter

Name	Type	Range	Default
<n>	Discrete	{1 2 3 4}	-
<value>	Real	(-5 x VerticalScale - OFFSet) to (5 x VerticalScale - OFFSet)	0
<type>	Discrete	{PAL TX RX SCL SDA CS CLK MISO MOSI LIN CAN PALCLK CH1 CH2 CH3 CH4}	-

Remarks

For VerticalScale, refer to the `:CHANnel<n>:SCALE` command. For OFFSet, refer to the `:CHANnel<n>:OFFSet` command.

- **PAL:** indicates the bus source of Parallel decoding.
- **PALCLK:** indicates the clock source of Parallel decoding. Only when the source is enabled, can you set the threshold.
- **TX:** indicates the TX channel source of RS232 decoding.
- **RX:** indicates the RX channel source of RS232 decoding. Only when the RX source is enabled, can you set the threshold.
- **SCL:** indicates the clock source of I2C decoding.
- **SDA:** indicates the clock source of I2C decoding.
- **CS:** indicates the source of the CS line of SPI decoding.
- **CLK:** indicates the clock source of SPI decoding.
- **MISO:** indicates the MISO data source of SPI decoding.
- **MOSI:** indicates the MOSI data source of SPI decoding.
- **LIN:** indicates the bus source of LIN decoding.
- **CAN:** indicates the source of CAN decoding.
- **CH1|CH2|CH3|CH4:** CH1-CH4, available for all the decoding types.

Only the DHO900 series supports LIN decodings.

For the DHO800 series, only the 4-channel model supports CS in SPI decoding.

Return Format

The query returns the threshold of the specified decoding source in scientific notation.

Example

```
:BUS1:THReshold 2.4,PAL /*Sets the threshold of the Parallel
decoding source to 2.4 V.*/
:BUS1:THReshold? PAL /*The query returns 2.400000E0.*/
```

3.4.10 :BUS<n>:PARAllel

:BUS<n>:PARAllel commands are used to set relevant parameters for parallel decoding.

Parallel bus consists of clock line and data line. As shown in the figure below, CLK is the clock line, whereas Bit0 and Bit1 are the 0 bit and 1st bit on the data line respectively. The oscilloscope will sample the channel data on the rising edge, falling edge, or the rising/falling edge of the clock and judge each data point (logic "1" or logic "0") according to the preset threshold level.

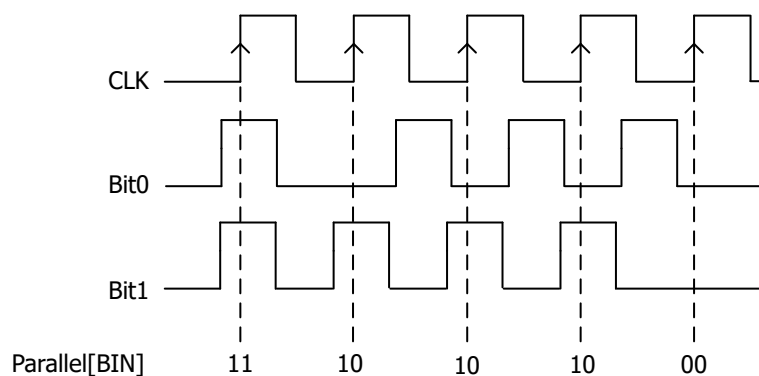

Figure 3.1 Schematic Diagram of Parallel Decoding

3.4.10.1 :BUS<n>:PARAllel:BUS

Syntax

```
:BUS<n>:PARAllel:BUS <source>
```

```
:BUS<n>:PARAllel:BUS?
```

Description

Sets or queries the source of Parallel decoding on the specific bus.

Parameter

Name	Type	Range	Default
<n>	Discrete	{1 2 3 4}	-
<source>	Discrete	{D7D0 D15D8 D15D0 D0D7 D8D15 D0D15 CHANnel1 CHANnel2 CHANnel3 CHANnel4 USER}	CHANnel1

Remarks

Digital channels (D0 to D15) are only supported by the DHO900 series.

Return Format

The query returns D7D0, D15D8, D15D0, D0D7, D8D15, D0D15, CHAN1, CHAN3, CHAN4, or USER.

Example

```
:BUS1:PARallel:BUS CHANnel1 /*Sets the source of Parallel
decoding to CHANnel1.*/
:BUS1:PARallel:BUS? /*The query returns CHAN1.*/
```

3.4.10.2 :BUS<n>:PARallel:CLK**Syntax**

```
:BUS<n>:PARallel:CLK <source>
```

```
:BUS<n>:PARallel:CLK?
```

Description

Sets or queries the clock source of Parallel decoding on the specified bus.

Parameter

Name	Type	Range	Default
<n>	Discrete	{1 2 3 4}	-
<source>	Discrete	{D0 D1 D2 D3 D4 D5 D6 D7 D8 D9 D10 D11 D12 D13 D14 D15 CHANnel1 CHANnel2 CHANnel3 CHANnel4 OFF}	OFF

Remarks

N/A

Digital channels (D0 to D15) are only supported by the DHO900 series.

Return Format

The query returns D0, D1, D2, D3, D4, D5, D6, D7, D8, D9, D10, D11, D12, D13, D14, D15, CHAN1, CHAN2, CHAN3, CHAN4, or OFF.

Example

```
:BUS1:PARAllel:CLK CHANnel2 /*Sets the clock source of Parallel
decoding to CHANnel2.*/
:BUS1:PARAllel:CLK? /*The query returns CHAN2.*/
```

3.4.10.3 :BUS<n>:PARAllel:SLOPe**Syntax**

```
:BUS<n>:PARAllel:SLOPe <slope>
```

```
:BUS<n>:PARAllel:SLOPe?
```

Description

Sets or queries the edge type of the clock channel when being sampled by Parallel decoding on the data channel.

Parameter

Name	Type	Range	Default
<n>	Discrete	{1 2 3 4}	-
<slope>	Discrete	{POSitive NEGative BOTH}	POSitive

Remarks

If no clock channel is selected, the instrument will sample when the channel data hopping occurs during the decoding.

Return Format

The query returns POS, NEG, or BOTH.

Example

```
:BUS1:PARAllel:SLOPe BOTH /*Sets the Parallel decoding to
sample on any edge of the clock channel.*/
:BUS1:PARAllel:SLOPe? /*The query returns BOTH.*/
```

3.4.10.4 :BUS<n>:PARAllel:WIDTh**Syntax**

```
:BUS<n>:PARAllel:WIDTh <wid>
```

```
:BUS<n>:PARAllel:WIDTh?
```

Description

Sets or queries the data width (number of bits per frame) of Parallel decoding on the specified bus.

Parameter

Name	Type	Range	Default
<n>	Discrete	{1 2 3 4}	-
<wid>	Integer	1 to 4	1

Remarks

- Only when the data source is set to User (*BUS<n>:PARAllel:BUS USER*), can this command be available to use.
- After you send this command to set the data width of the bus, send the *:BUS<n>:PARAllel:BITX* and *:BUS<n>:PARAllel:SOURce* commands to select the bit respectively and set the channel source for the bit.

Return Format

The query returns an integer ranging from 1 to 4.

Example

```
:BUS1:PARAllel:WIDTh 4 /*Sets the data width of Parallel
decoding to 4.*/
:BUS1:PARAllel:WIDTh? /*The query returns 4.*/
```

3.4.10.5 :BUS<n>:PARAllel:BITX**Syntax**

```
:BUS<n>:PARAllel:BITX <bit>
```

```
:BUS<n>:PARAllel:BITX?
```

Description

Sets or queries the data bit that the parallel bus requires to set for the channel source.

Parameter

Name	Type	Range	Default
<n>	Discrete	{1 2 3 4}	-
<bit>	Integer	0 to (data width - 1)	0

Remarks

- Only when the bus source is set to User (*BUS<n>:PARAllel:BUS USER*), can this command be valid.
- The data width is set by the *:BUS<n>:PARAllel:WIDTh* command.
- After selecting the desired bit, send the *:BUS<n>:PARAllel:SOURce* command to set the channel source for the bit.

Return Format

The query returns the current data bits in integer. Its unit is Hz.

Example

```
:BUS1:PARAllel:BITX 2 /*Sets the current bit to 2.*/  
:BUS1:PARAllel:BITX? /*The query returns 2.*/
```

3.4.10.6 :BUS<n>:PARAllel:SOURce**Syntax**

```
:BUS<n>:PARAllel:SOURce <src>
```

```
:BUS<n>:PARAllel:SOURce?
```

Description

Sets or queries the channel source of the currently selected data bit.

Parameter

Name	Type	Range	Default
<n>	Discrete	{1 2 3 4}	-
<src>	Discrete	{D0 D1 D2 D3 D4 D5 D6 D7 D8 D9 D10 D11 D12 D13 D14 D15 CHANnel1 CHANnel2 CHANnel3 CHANnel4}	Related to the selected bit

Remarks

- Only when the bus source is set to User (*BUS<n>:PARAllel:BUS USER*), can this command be valid.
- Before sending this command, send the *:BUS<n>:PARAllel:BITX* command to select the desired data bit.
- D0-D15 are only available for the DHO900 series.

Return Format

The query returns D0, D1, D2, D3, D4, D5, D6, D7, D8, D9, D10, D11, D12, D13, D14, D15, CHAN1, CHAN2, CHAN3, or CHAN4.

Example

```
:BUS1:PARAllel:SOURce CHANnel2 /*Sets the channel source of the
current bit to CHANnel2.*/
:BUS1:PARAllel:SOURce? /*The query returns CHAN2.*/
```

3.4.10.7 :BUS<n>:PARAllel:ENDian**Syntax**

```
:BUS <n>:PARAllel:ENDian <endian>
:BUS <n>:PARAllel:ENDian?
```

Description

Sets or queries the endian of Parallel decoding on the specified decoding bus.

Parameter

Name	Type	Range	Default
<n>	Discrete	{1 2 3 4}	-
<endian>	Discrete	{MSB LSB}	MSB

Remarks

- **MSB:** indicates Most Significant Bit transmission sequence, i.g. the highest bit of the data is transmitted first.
- **LSB:** indicates Least Significant Bit transmission sequence, i.g. the lowest bit of the data is transmitted first.

Return Format

The query returns MSB or LSB.

Example

```
:BUS1:PARAllel:ENDian LSB /*Sets the endian of Parallel decoding
to LSB.*/
:BUS1:PARAllel:ENDian? /*The query returns LSB.*/
```

3.4.10.8 :BUS<n>:PARAllel:POLarity**Syntax**

```
:BUS <n>:PARAllel:POLarity <pol>
```

:BUS<n>:PARallel:POLarity?

Description

Sets or queries the data polarity of Parallel decoding.

Parameter

Name	Type	Range	Default
<n>	Discrete	{1 2 3 4}	-
<pol>	Discrete	{NEGative POSitive}	POSitive

Remarks

- **NEGative:** indicates negative polarity.
- **POSitive:** indicates positive polarity.

Return Format

The query returns NEG or POS.

Example

```
:BUS1:PARallel:POLarity NEGative /*Sets the data polarity of
Parallel decoding to Negative.*/
:BUS1:PARallel:POLarity? /*The query returns NEG.*/
```

3.4.11 :BUS<n>:RS232

The :BUS<n>:RS232 commands are used to set relevant parameters for RS232 decoding.

RS232 serial bus consists of the transmitting data line (TX) and the receiving data line (RX).

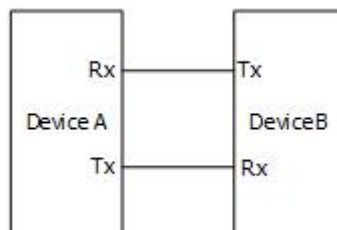
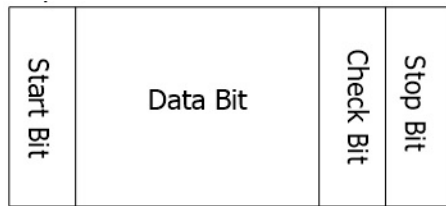

Figure 3.2 Schematic Diagram of RS232 Serial Bus

In RS232, baud rate is used to represent the transmission rate (namely bits per second) of the data. In RS232, you need to set the start bit, data bits, check bit (optional), and stop bit for each frame of data.



- **Start Bit:** indicates when to output data.
- **Data Bits:** indicates the number of data bits actually contained in each frame of data.
- **Check Bit:** used to check whether the data are properly transmitted.
- **Stop Bit:** indicates when to stop outputting data.

3.4.11.1 :BUS<n>:RS232:TX

Syntax

```
:BUS<n> :RS232 :TX <source>
```

```
:BUS<n> :RS232 :TX?
```

Description

Sets or queries the Tx source of RS232 decoding on the specific bus.

Parameter

Name	Type	Range	Default
<n>	Discrete	{1 2 3 4}	-
<source>	Discrete	{D0 D1 D2 D3 D4 D5 D6 D7 D8 D9 D10 D11 D12 D13 D14 D15 CHANnel1 CHANnel2 CHANnel3 CHANnel4 OFF}	CHANnel1

Remarks

The Tx and Rx sources cannot be set to OFF at the same time. The Rx source can be set by using the *:BUS<n>:RS232:RX* command.

D0-D15 are only available for the DHO900 series.

Return Format

The query returns D0, D1, D2, D3, D4, D5, D6, D7, D8, D9, D10, D11, D12, D13, D14, D15, CHAN1, CHAN2, CHAN3, CHAN4, or OFF.

Example

```
:BUS1:RS232:TX CHANnel2 /*Sets the Tx source of RS232 decoding
to CHANnel2.*/
:BUS1:RS232:TX? /*The query returns CHAN2.*/
```

3.4.11.2 :BUS<n>:RS232:RX**Syntax**

```
:BUS<n>:RS232:RX <source>
```

```
:BUS<n>:RS232:RX?
```

Description

Sets or queries the Rx source of RS232 decoding on the specific bus.

Parameter

Name	Type	Range	Default
<n>	Discrete	{1 2 3 4}	-
<source>	Discrete	{D0 D1 D2 D3 D4 D5 D6 D7 D8 D9 D10 D11 D12 D13 D14 D15 CHANnel1 CHANnel2 CHANnel3 CHANnel4 OFF}	OFF

Remarks

The Tx and Rx sources cannot be set to OFF at the same time. The Tx source can be set by using the *:BUS<n>:RS232:TX* command.

D0-D15 are only available for the DHO900 series.

Return Format

The query returns D0, D1, D2, D3, D4, D5, D6, D7, D8, D9, D10, D11, D12, D13, D14, D15, CHAN1, CHAN2, CHAN3, CHAN4, or OFF.

Example

```
:BUS1:RS232:RX CHANnel2 /*Sets the Rx source of RS232 decoding
to CHANnel2.*/
:BUS1:RS232:RX? /*The query returns CHAN2.*/
```

3.4.11.3 :BUS<n>:RS232:POLarity**Syntax**

```
:BUS<n>:RS232:POLarity <pol>
```

```
:BUS<n>:RS232:POLarity?
```

Description

Sets or queries the polarity of RS232 decoding on the specified bus.

Parameter

Name	Type	Range	Default
<n>	Discrete	{1 2 3 4}	-
<pol>	Discrete	{POSitive NEGative}	NEGative

Remarks

- **POSitive:** indicates positive polarity. High level is logic "1" and low level is logic "0".
- **NEGative:** indicates negative polarity. High level is logic "0" and low level is logic "1".

Return Format

The query returns POS or NEG.

Example

```
:BUS1:RS232:POLarity POSitive /*Sets the polarity of RS232
decoding to POSitive.*/
:BUS1:RS232:POLarity? /*The query returns POS.*/
```

3.4.11.4 :BUS<n>:RS232:PARity**Syntax**

```
:BUS<n>:RS232:PARity <parity>
```

```
:BUS<n>:RS232:PARity?
```

Description

Sets or queries the odd-even check mode of data transmission in RS232 decoding.

Parameter

Name	Type	Range	Default
<n>	Discrete	{1 2 3 4}	-
<parity>	Discrete	{NONE ODD EVEN}	NONE

Remarks

- **None:** indicates that there is no parity bit in data transmission.

- **ODD:** indicates the odd parity bit. The total count of occurrences of 1 in the data bit and check bit is an odd number. For example, if 0x55 (01010101) is transmitted, 1 shall be added to the check bit.
- **Even:** indicates the even parity bit. The total count of occurrences of 1 in the data bit and check bit is an even number. For example, if 0x55 (01010101) is transmitted, 0 shall be added to the check bit.

Return Format

The query returns NONE, ODD, or EVEN.

Example

```
:BUS1:RS232:PARity ODD /*Sets the odd-even check mode of
data transmission in RS232 decoding to ODD.*/
:BUS1:RS232:PARity? /*The query returns ODD.*/
```

3.4.11.5 :BUS<n>:RS232:ENDian

Syntax

```
:BUS<n>:RS232:ENDian <endian>
```

```
:BUS<n>:RS232:ENDian?
```

Description

Sets or queries the endian of data transmission in RS232 decoding.

Parameter

Name	Type	Range	Default
<n>	Discrete	{1 2 3 4}	-
<endian>	Discrete	{MSB LSB}	LSB

Remarks

- **LSB:** indicates Least Significant Bit transmission sequence, that is, the lowest bit of the data is transmitted first.
- **MSB:** indicates Most Significant Bit transmission sequence, that is, the highest bit of the data is transmitted first.

Return Format

The query returns LSB or MSB.

Example

```
:BUS1:RS232:ENDian MSB /*Sets the transmission order of
RS232 decoding to MSB.*/
:BUS1:RS232:ENDian? /*The query returns MSB.*/
```

3.4.11.6 :BUS<n>:RS232:BAUD**Syntax**

```
:BUS<n>:RS232:BAUD <baud>
```

```
:BUS<n>:RS232:BAUD?
```

Description

Sets or queries the baud rate of data transmission in RS232 decoding. The default unit is bps.

Parameter

Name	Type	Range	Default
<n>	Discrete	{1 2 3 4}	-
<baud>	Integer	1bps to 20Mbps	9600 bps

Remarks

If the baud rate is set to a value with "M", then "A" should be added at the end of the value. For example, if you send 5M, you need to send 5MA.

Return Format

The query returns an integer ranging from 1 to 20M.

Example

```
:BUS1:RS232:BAUD 4800 /*Sets the baud rate of data
transmission in RS232 decoding to 4800 bps.*/
:BUS1:RS232:BAUD? /*The query returns 4800.*/
```

3.4.11.7 :BUS<n>:RS232:DBITs**Syntax**

```
:BUS<n>:RS232:DBITs <bits>
```

```
:BUS<n>:RS232:DBITs?
```

Description

Sets or queries the data width of RS232 decoding.

Parameter

Name	Type	Range	Default
<n>	Discrete	{1 2 3 4}	-
<bits>	Discrete	{5 6 7 8 9}	8

Remarks

N/A

Return Format

The query returns 5, 6, 7, 8, or 9.

Example

```
:BUS1:RS232:DBITs 7 /*Sets the data width of RS232 decoding to 7.*/  
:BUS1:RS232:DBITs? /*The query returns 7.*/*
```

3.4.11.8 :BUS<n>:RS232:SBITs**Syntax**

```
:BUS<n>:RS232:SBITs <stop bits>
```

```
:BUS<n>:RS232:SBITs?
```

Description

Sets or queries the stop bits of each frame of data in RS232 decoding.

Parameter

Name	Type	Range	Default
<n>	Discrete	{1 2 3 4}	-
<stop bits>	Discrete	{1 1.5 2}	1

Remarks

N/A

Return Format

The query returns 1, 1.5, or 2.

Example

```
:BUS1:RS232:SBITs 2 /*Sets the stop bits of RS232 decoding to 2.*/  
:BUS1:RS232:SBITs? /*The query returns 2.*/*
```

3.4.12 :BUS<n>:IIC

The :BUS<n>:IIC commands are used to set relevant parameters for I2C decoding.

I2C serial bus consists of the clock line (SCL) and the data line (SDA).

- **SCL:** samples SDA on the of rising or falling edge of the clock.
- **SDA:** indicates the data channel.

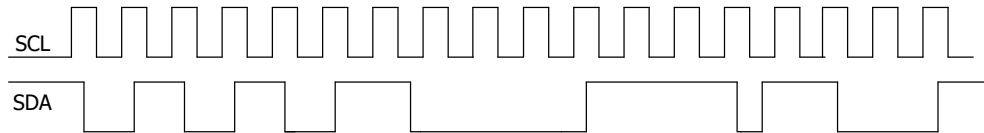

Figure 3.3 I2C Serial Bus

3.4.12.1 :BUS<n>:IIC:SCLK:SOURce

Syntax

```
:BUS<n> : IIC : SCLK : SOURce <source>
```

```
:BUS<n> : IIC : SCLK : SOURce?
```

Description

Sets or queries the clock source of I2C decoding.

Parameter

Name	Type	Range	Default
<n>	Discrete	{1 2 3 4}	-
<source>	Discrete	{D0 D1 D2 D3 D4 D5 D6 D7 D8 D9 D10 D11 D12 D13 D14 D15 CHANnel1 CHANnel2 CHANnel3 CHANnel4}	CHANnel1

Remarks

Digital channels (D0 to D15) are only supported by the DHO900 series.

Return Format

The query returns D0, D1, D2, D3, D4, D5, D6, D7, D8, D9, D10, D11, D12, D13, D14, D15, CHAN1, CHAN2, CHAN3, or CHAN4.

Example

```
:BUS1:IIC:SCLK:SOURce CHANnel2 /*Sets the clock source of I2C
decoding to CHANnel2.*/
:BUS1:IIC:SCLK:SOURce? /*The query returns CHAN2.*/
```

3.4.12.2 :BUS<n>:IIC:SDA:SOURce**Syntax**

```
:BUS<n> : IIC : SDA : SOURce <source>
```

```
:BUS<n> : IIC : SDA : SOURce?
```

Description

Sets or queries the data source of the I2C decoding on the specified bus.

Parameter

Name	Type	Range	Default
<n>	Discrete	{1 2 3 4}	-
<source>	Discrete	{D0 D1 D2 D3 D4 D5 D6 D7 D8 D9 D10 D11 D12 D13 D14 D15 CHANnel1 CHANnel2 CHANnel3 CHANnel4}	CHANnel1

Remarks

Digital channels (D0 to D15) are only supported by the DHO900 series.

Return Format

The query returns D0, D1, D2, D3, D4, D5, D6, D7, D8, D9, D10, D11, D12, D13, D14, D15, CHAN1, CHAN2, CHAN3, or CHAN4.

Example

```
:BUS1:IIC:SDA:SOURce CHANnel2 /*Sets the data source of I2C
decoding to CHANnel2.*/
:BUS1:IIC:SDA:SOURce? /*The query returns CHAN2.*/
```

3.4.12.3 :BUS<n>:IIC:EXCHange**Syntax**

```
:BUS<n> : IIC : EXCHange <bool>
```

```
:BUS<n> : IIC : EXCHange?
```

Description

Sets to exchange the clock channel source and the data channel source of I2C decoding on the specified bus; queries whether the clock channel source and the data channel source of I2C decoding on the specified bus have been exchanged.

Parameter

Name	Type	Range	Default
<n>	Discrete	{1 2 3 4}	-
<bool>	Bool	{{1 ON}} {0 OFF}}	0 OFF

Remarks

N/A

Return Format

The query returns 0 or 1.

Example

```
:BUS1:IIC:EXCHange ON /*Sets to exchange the clock channel source
and the data channel source.*/
:BUS1:IIC:EXCHange? /*The query returns 1.*/
```

3.4.12.4 :BUS<n>:IIC:ADDRess**Syntax**

```
:BUS<n>:IIC:ADDRess <addr>
```

```
:BUS<n>:IIC:ADDRess?
```

Description

Sets or queries the address mode of I2C decoding.

Parameter

Name	Type	Range	Default
<n>	Discrete	{1 2 3 4}	-
<addr>	Discrete	{NORMAL RW}	NORMAL

Remarks

- **NORMAL:** indicates that the address width does not include the R/W bit.
- **RW:** indicates that the address width includes the R/W bit.

Return Format

The query returns NORM or RW.

Example

```
:BUS1:IIC:ADDRess RW /*Sets the address of I2C decoding to
include the R/W bit.*/
:BUS1:IIC:ADDRess? /*The query returns RW.*/
```

3.4.13 :BUS<n>:SPI

The :BUS<n>:SPI commands are used to set relevant parameters for SPI decoding.

SPI bus is based on the master-slave configuration and usually consists of chip select line (CS), clock line (CLK), and data line (SDA). Wherein, the data lines include the master input/slave output (MISO) data line and master output/slave input (MOSI) data line. The oscilloscope will sample the channel data on the rising edge, falling edge, or the rising/falling edge of the clock and judge each data point (logic "1" or logic "0") according to the preset threshold level).

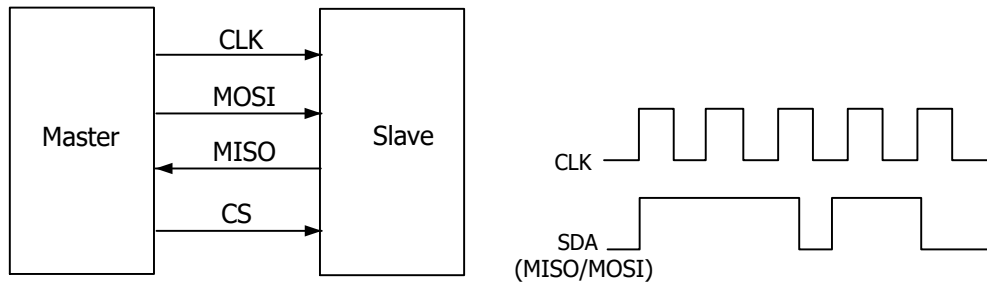

Figure 3.4 SPI Serial Bus

3.4.13.1 :BUS<n>:SPI:SCLK:SOURce

Syntax

:BUS<n> :SPI :SCLK :SOURce <source>

:BUS<n> :SPI :SCLK :SOURce?

Description

Sets or queries the clock source of SPI decoding on the specified bus.

Parameter

Name	Type	Range	Default
<n>	Discrete	{1 2 3 4}	-
<source>	Discrete	{D0 D1 D2 D3 D4 D5 D6 D7 D8 D9 D10 D11 D12 D13 D14 D15 CHANnel1 CHANnel2 CHANnel3 CHANnel4}	CHANnel1

Remarks

Digital channels (D0 to D15) are only supported by the DHO900 series.

Return Format

The query returns D0, D1, D2, D3, D4, D5, D6, D7, D8, D9, D10, D11, D12, D13, D14, D15, CHAN1, CHAN2, CHAN3, or CHAN4.

Example

```
:BUS1:SPI:SCLK:SOURce CHANnel2 /*Sets the clock source of SPI
decoding to CHANnel2.*/
:BUS1:SPI:SCLK:SOURce? /*The query returns CHAN2.*/
```

3.4.13.2 :BUS<n>:SPI:SCLK:SLOPe**Syntax**

```
:BUS<n>:SPI:SCLK:SLOPe <slope>
```

```
:BUS<n>:SPI:SCLK:SLOPe?
```

Description

Sets or queries the clock edge type of the SPI decoding.

Parameter

Name	Type	Range	Default
<n>	Discrete	{1 2 3 4}	-
<slope>	Discrete	{POSitive NEGative}	POSitive

Remarks

N/A

Return Format

The query returns POS or NEG.

Example

```
:BUS1:SPI:SCLK:SLOPe NEGative /*Sets the clock edge type of SPI
decoding to Negative.*/
:BUS1:SPI:SCLK:SLOPe? /*The query returns NEG.*/
```

3.4.13.3 :BUS<n>:SPI:MISO:SOURce**Syntax**

```
:BUS<n>:SPI:MISO:SOURce <source>
```

```
:BUS<n>:SPI:MISO:SOURce?
```

Description

Sets or queries the MISO data source of SPI decoding on the specified bus.

Parameter

Name	Type	Range	Default
<n>	Discrete	{1 2 3 4}	-
<source>	Discrete	{D0 D1 D2 D3 D4 D5 D6 D7 D8 D9 D10 D11 D12 D13 D14 D15 CHANnel1 CHANnel2 CHANnel3 CHANnel4 OFF}	CHANnel2

Remarks

The source specified in this command and the *:BUS<n>:SPI:MOSI:SOURce* command cannot be set to OFF at the same time.

D0-D15 are only available for the DHO900 series.

Return Format

The query returns D0, D1, D2, D3, D4, D5, D6, D7, D8, D9, D10, D11, D12, D13, D14, D15, CHAN1, CHAN2, CHAN3, CHAN4, or OFF.

Example

```
:BUS1:SPI:MISO:SOURce CHANnel2 /*Sets the MISO data source of
SPI decoding to CHANnel2.*/
:BUS1:SPI:MISO:SOURce? /*The query returns CHAN2.*/
```

3.4.13.4 :BUS<n>:SPI:MOSI:SOURce**Syntax**

```
:BUS<n>:SPI:MOSI:SOURce <source>
```

```
:BUS<n>:SPI:MOSI:SOURce?
```

Description

Sets or queries the MOSI data source of SPI decoding on the specified bus.

Parameter

Name	Type	Range	Default
<n>	Discrete	{1 2 3 4}	-
<source>	Discrete	{D0 D1 D2 D3 D4 D5 D6 D7 D8 D9 D10 D11 D12 D13 D14 D15 CHANnel1 CHANnel2 CHANnel3 CHANnel4 OFF}	OFF

Remarks

The source specified in this command and the `:BUS<n>:SPI:MISO:SOURce` command cannot be set to OFF at the same time.

D0-D15 are only available for the DHO900 series.

Return Format

The query returns D0, D1, D2, D3, D4, D5, D6, D7, D8, D9, D10, D11, D12, D13, D14, D15, CHAN1, CHAN2, CHAN3, CHAN4, or OFF.

Example

```
:BUS1:SPI:MOSI:SOURce CHANnel2 /*Sets the MOSI data source of
SPI decoding to CHANnel2.*/
:BUS1:SPI:MOSI:SOURce? /*The query returns CHAN2.*/
```

3.4.13.5 :BUS<n>:SPI:POLarity**Syntax**

```
:BUS<n>:SPI:POLarity <polarity>
```

```
:BUS<n>:SPI:POLarity?
```

Description

Sets or queries the polarity of the SPI decoding on the specified decoding bus.

Parameter

Name	Type	Range	Default
<n>	Discrete	{1 2 3 4}	-
<polarity>	Discrete	{HIGH LOW}	HIGH

Remarks

- **HIGH:** indicates positive polarity. The high level is 1, and low level is 0.
- **LOW:** indicates negative polarity. The high level is 0, and low level is 1.

Return Format

The query returns HIGH or LOW.

Example

```
:BUS1:SPI:POLarity HIGH /*Sets the polarity of the SPI
decoding to Positive.*/
:BUS1:SPI:POLarity? /*The query returns HIGH.*/
```

3.4.13.6 :BUS<n>:SPI:MISO:POLarity

Syntax

```
:BUS<n>:SPI:MISO:POLarity <polarity>
```

```
:BUS<n>:SPI:MISO:POLarity?
```

Description

Sets or queries the polarity of MISO data line of SPI decoding.

Parameter

Name	Type	Range	Default
<n>	Discrete	{1 2 3 4}	-
<polarity>	Discrete	{HIGH LOW}	HIGH

Remarks

- **HIGH:** positive polarity. It indicates that high level is 1, and low level is 0.
- **LOW:** negative polarity. It indicates that low level is 1, and high level is 0.

This command exists for backwards compatibility. Use the command *:BUS<n>:SPI:POLarity*.

Return Format

The query returns HIGH or LOW.

Example

```
:BUS1:SPI:MISO:POLarity HIGH /*Sets the polarity of MISO data
line to Positive.*/
:BUS1:SPI:MISO:POLarity? /*The query returns HIGH.*/
```

3.4.13.7 :BUS<n>:SPI:MOSI:POLarity

Syntax

```
:BUS<n>:SPI:MOSI:POLarity <polarity>
```

```
:BUS<n>:SPI:MOSI:POLarity?
```

Description

Sets or queries the polarity of MOSI data line of SPI decoding.

Parameter

Name	Type	Range	Default
<n>	Discrete	{1 2 3 4}	-

Name	Type	Range	Default
<polarity>	Discrete	{HIGH LOW}	HIGH

Remarks

- **HIGH:** positive polarity. It indicates that high level is 1, and low level is 0.
- **LOW:** negative polarity. It indicates that low level is 1, and high level is 0.

Return Format

The query returns HIGH or LOW.

Example

```
:BUS1:SPI:MOSI:POLarity HIGH /*Sets the polarity of MOSI data
line to HIGH.*/
:BUS1:SPI:MOSI:POLarity? /*The query returns HIGH.*/
```

3.4.13.8 :BUS<n>:SPI:DBITs**Syntax**

```
:BUS<n>:SPI:DBITs <width>
```

```
:BUS<n>:SPI:DBITs?
```

Description

Sets or queries the data width of SPI decoding.

Parameter

Name	Type	Range	Default
<n>	Discrete	{1 2 3 4}	-
<width>	Integer	4 to 32	8

Remarks

N/A

Return Format

The query returns an integer ranging from 4 to 32.

Example

```
:BUS1:SPI:DBITs 10 /*Sets the data width of SPI decoding to
10.*/
:BUS1:SPI:DBITs? /*The query returns 10.*/
```

3.4.13.9 :BUS<n>:SPI:ENDian**Syntax**

```
:BUS<n>:SPI:ENDian <endian>
```

```
:BUS<n>:SPI:ENDian?
```

Description

Sets or queries the endian of data transmission in SPI decoding.

Parameter

Name	Type	Range	Default
<n>	Discrete	{1 2 3 4}	-
<endian>	Discrete	{MSB LSB}	MSB

Remarks

- **MSB:** indicates Most Significant Bit transmission sequence, that is, the highest bit of the data is transmitted first.
- **LSB:** indicates Least Significant Bit transmission sequence, that is, the lowest bit of the data is transmitted first.

Return Format

The query returns MSB or LSB.

Example

```
:BUS1:SPI:ENDian LSB /*Sets the endian of data transmission
in SPI decoding to LSB.*/
:BUS1:SPI:ENDian? /*The query returns LSB.*/
```

3.4.13.10 :BUS<n>:SPI:MODE**Syntax**

```
:BUS<n>:SPI:MODE <mode>
```

```
:BUS<n>:SPI:MODE?
```

Description

Sets or queries the decode mode of SPI decoding.

Parameter

Name	Type	Range	Default
<n>	Discrete	{1 2 3 4}	-
<mode>	Discrete	{CS TIMEout}	TIMEout

Remarks

- **CS:** indicates chip select. It contains a chip select line (CS). You can perform frame synchronization according to CS.
- **TIMEout:** indicates timed out. You can perform frame synchronization according to the timeout.

For DHO800 series, only 4-channel models support CS setting for SPI decoding.

Return Format

The query returns CS or TIM.

Example

```
:BUS1:SPI:MODE CS /*Sets the decode mode of SPI decoding to CS.*/
:BUS1:SPI:MODE? /*The query returns CS.*/
```

3.4.13.11 :BUS<n>:SPI:TIMEout:TIME**Syntax**

```
:BUS<n>:SPI:TIMEout:TIME <time>
```

```
:BUS<n>:SPI:TIMEout:TIME?
```

Description

Sets or queries the timeout value of SPI decoding on the specified bus. The unit is s.

Parameter

Name	Type	Range	Default
<n>	Discrete	{1 2 3 4}	-
<time>	Real	8 ns to 10 s	1μs

Remarks

- This setting command is only valid in timeout mode. You can send `:BUS<n>:SPI:MODE` to set or query the decode mode of SPI decoding.

- The timeout must be greater than the maximum clock pulse width and less than the idle time between frames.

Return Format

The query returns the timeout value in scientific notation.

Example

```
:BUS1:SPI:TIMEout:TIME 0.000005 /*Sets the timeout value to 5
µs.*/
:BUS1:SPI:TIMEout:TIME? /*The query returns
5.000000E-6.*/
```

3.4.13.12 :BUS<n>:SPI:SS:SOURce

Syntax

```
:BUS<n>:SPI:SS:SOURce <source>
```

```
:BUS<n>:SPI:SS:SOURce?
```

Description

Sets or queries the source of the CS line of SPI decoding on the specified bus.

Parameter

Name	Type	Range	Default
<n>	Discrete	{1 2 3 4}	-
<source>	Discrete	{D0 D1 D2 D3 D4 D5 D6 D7 D8 D9 D10 D11 D12 D13 D14 D15 CHANnel1 CHANnel2 CHANnel3 CHANnel4}	CHANnel3

Remarks

This setting command is only valid in CS mode. You can send `:BUS<n>:SPI:MODE` to set or query the decode mode of the SPI decoding.

Only DHO900 series supports the digital channels D0-D15.

For DHO800 series, only 4-channel models support this command.

Return Format

The query returns D0, D1, D2, D3, D4, D5, D6, D7, D8, D9, D10, D11, D12, D13, D14, D15, CHAN1, CHAN2, CHAN3, or CHAN4.

Example

```
:BUS1:SPI:SS:SOURce CHANnel2 /*Sets the source of CS line of
SPI decoding to CHANnel2.*/
:BUS1:SPI:SS:SOURce? /*The query returns CHAN2.*/
```

3.4.13.13 :BUS<n>:SPI:SS:POLarity**Syntax**

```
:BUS<n>:SPI:SS:POLarity <polarity>
```

```
:BUS<n>:SPI:SS:POLarity?
```

Description

Sets or queries the polarity of CS line of SPI decoding on the specified bus.

Parameter

Name	Type	Range	Default
<n>	Discrete	{1 2 3 4}	-
<polarity>	Discrete	{HIGH LOW}	LOW

Remarks

- **HIGH:** indicates that the oscilloscope samples data of the source channel of data line on the specified edge of the clock signal when the CS signal is high level.
- **LOW:** indicates that the oscilloscope samples data of the source channel of data line on the specified edge of the clock signal when the CS signal is low level.

This setting command is only valid in CS mode. You can send `:BUS<n>:SPI:MODE` to set or query the decode mode of the SPI decoding.

For DHO800 series, only 4-channel models support this command.

Return Format

The query returns HIGH or LOW.

Example

```
:BUS1:SPI:SS:POLarity HIGH /*Sets the polarity of CS line of SPI
decoding to HIGH.*/
:BUS1:SPI:SS:POLarity? /*The query returns HIGH.*/
```

3.4.14 :BUS<n>:CAN

The `:BUS<n>:CAN` commands are used to set relevant parameters for CAN decoding.

The oscilloscope samples the CAN or signal at the specified sample position, and judges each data point to be logic "1" or logic "0" according to the preset threshold level. You need to specify the CAN signal type and sample position for CAN decoding.

Sample Position

Sample position is a point within a bit's time. The oscilloscope samples the bit level at this point. The sample point position is expressed as the ratio of "time from the bit start to the sample point" to "bit time", in %.

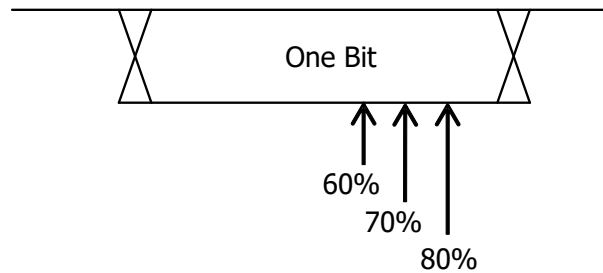

Figure 3.5 Sample Position

3.4.14.1 :BUS<n>:CAN:SOURce

Syntax

:BUS<n>:CAN:SOURce <source>

:BUS<n>:CAN:SOURce?

Description

Sets or queries the source of CAN decoding on the specific bus.

Parameter

Name	Type	Range	Default
<n>	Discrete	{1 2 3 4}	-
<source>	Discrete	{D0 D1 D2 D3 D4 D5 D6 D7 D8 D9 D10 D11 D12 D13 D14 D15 CHANnel1 CHANnel2 CHANnel3 CHANnel4}	CHANnel1

Remarks

Digital channels (D0 to D15) are only supported by the DHO900 series.

Return Format

The query returns D0, D1, D2, D3, D4, D5, D6, D7, D8, D9, D10, D11, D12, D13, D14, D15, CHAN1, CHAN2, CHAN3, or CHAN4.

Example

```
:BUS1:CAN:SOURce CHANnel2 /*Sets the source of CAN decoding to
CHANnel2.*/*
:BUS1:CAN:SOURce? /*The query returns CHAN2.*/*
```

3.4.14.2 :BUS<n>:CAN:STYPe**Syntax**

```
:BUS<n>:CAN:STYPe <stype>
```

```
:BUS<n>:CAN:STYPe?
```

Description

Sets or queries the signal type of CAN decoding.

Parameter

Name	Type	Range	Default
<n>	Discrete	{1 2 3 4}	-
<stype>	Discrete	{TX RX CANH CANL DIFFerential}	CANL

Remarks

- **TX:** indicates the Transmit signal from the CAN bus transceiver.
- **RX:** indicates the Receive signal from the CAN bus transceiver.
- **CANH:** indicates the actual CAN_H differential bus signal.
- **CANL:** indicates the actual CAN_L differential bus signal.
- **DIFFerential:** indicates the CAN differential bus signal connected to an analog channel by using a differential probe. Connect the differential probe's positive lead to the CAN_H bus signal and connect the negative lead to the CAN_L bus signal.

Return Format

The query returns TX, RX, CANH, CANL, or DIFF.

Example

```
:BUS1:CAN:STYPe TX /*Sets the signal type of CAN decoding
to TX.*/*
:BUS1:CAN:STYPe? /*The query returns TX.*/*
```

3.4.14.3 :BUS<n>:CAN:BAUD**Syntax**

```
:BUS<n>:CAN:BAUD <baud>
```

```
:BUS<n>:CAN:BAUD?
```

Description

Sets or queries the signal rate of CAN decoding on the specified decoding bus. The unit is bps.

Parameter

Name	Type	Range	Default
<n>	Discrete	{1 2 3 4}	-
<baud>	Integer	10 kbps to 5 Mbps	1 Mbps

Remarks

If the baud rate is set to a value with "M", then "A" should be added at the end of the value. For example, if you send 5M, you need to send 5MA.

Return Format

The query returns an integer ranging from 10k to 5M.

Example

```
:BUS1:CAN:BAUD 120000 /*Sets the signal rate of CAN decoding to
120000 bps*/
:BUS1:CAN:BAUD? /*The query returns 120000.*/
```

3.4.14.4 :BUS<n>:CAN:SPOint**Syntax**

```
:BUS<n>:CAN:SPOint <spoint>
```

```
:BUS<n>:CAN:SPOint?
```

Description

Sets or queries the sample point position of the CAN decoding on the specified bus (expressed in %).

Parameter

Name	Type	Range	Default
<n>	Discrete	{1 2 3 4}	-
<spoint>	Integer	10 to 90	50

Remarks

For detailed sample position, refer to *Sample Position*.

Return Format

The query returns an integer ranging from 10 to 90.

Example

```
:BUS1:CAN:SPOint 70          /*Sets the sample point position of CAN
decoding to 70%.*/
:BUS1:CAN:SPOint?           /*The query returns 70.*/
```

3.4.15 :BUS<n>:LIN

The :BUS<n>:LIN commands are used to set relevant parameters for LIN decoding.

The oscilloscope samples the LIN signal at the specified sample position (if the source is an analog channel, the oscilloscope will also judge each data point (logic "1" or logic "0") according to the preset threshold level). You need to specify the LIN signal protocol version.

**NOTE**

Only the DHO900 series oscilloscope supports :BUS<n>:LIN commands.

3.4.15.1 :BUS<n>:LIN:PARity**Syntax**

```
:BUS<n>:LIN:PARity <bool>
```

```
:BUS<n>:LIN:PARity?
```

Description

Sets or queries whether the LIN decoding on the specified decoding bus includes the parity bit.

Parameter

Name	Type	Range	Default
<n>	Discrete	{1 2 3 4}	-
<bool>	Bool	{{1 ON}}{0 OFF}}	0 OFF

Remarks

- **1|ON:** includes the parity bit.
- **0|OFF:** does not include the parity bit.

Return Format

The query returns 0 or 1.

Example

```
:BUS1:LIN:PARity ON /*Sets the parity bit to be
included in LIN decoding.*/
:BUS1:LIN:PARity? /*The query returns 1.*/
```

3.4.15.2 :BUS<n>:LIN:SOURce**Syntax**

```
:BUS<n>:LIN:SOURce <source>
```

```
:BUS<n>:LIN:SOURce?
```

Description

Sets or queries the source of LIN decoding on the specific bus.

Parameter

Name	Type	Range	Default
<n>	Discrete	{1 2 3 4}	-
<source>	Discrete	{D0 D1 D2 D3 D4 D5 D6 D7 D8 D9 D10 D11 D12 D13 D14 D15 CHANnel1 CHANnel2 CHANnel3 CHANnel4}	CHANnel1

Remarks

Digital channels (D0 to D15) are only supported by the DHO900 series.

Return Format

The query returns D0, D1, D2, D3, D4, D5, D6, D7, D8, D9, D10, D11, D12, D13, D14, D15, CHAN1, CHAN2, CHAN3, or CHAN4.

Example

```
:BUS1:LIN:SOURce CHANnel2 /*Sets the source of LIN decoding to
CHANnel2.*/
:BUS1:LIN:SOURce? /*The query returns CHAN2.*/
```

3.4.15.3 :BUS<n>:LIN:STANdard**Syntax**

```
:BUS<n>:LIN:STANdard <value>
```

```
:BUS<n>:LIN:STANdard?
```

Description

Sets or queries the version of LIN bus.

Parameter

Name	Type	Range	Default
<n>	Discrete	{1 2 3 4}	-
<value>	Discrete	{V1X V2X MIXed}	MIXed

Remarks

N/A

Return Format

The query returns V1X, V2X, or MIX.

Example

```
:BUS1:LIN:STANdard V2X /*Sets the LIN bus version to
V2X.* /
:BUS1:LIN:STANdard? /*The query returns V2X.* /
```

3.5 :BODeploit Commands

The **:BODeploit** commands are used to execute the bode-related settings and operations.

Bode plot is a way of graphically displaying the frequency response of a system. Through the analysis on the system's gain and phase margins, you can determine the stability of the system.

With the built-in signal generator module, the oscilloscope generates the sweep signal of a specified frequency range and outputs to the switch power supply circuit under test. Then, the oscilloscope draws a Bode plot displaying the variation of phase and gain with different frequencies.

**NOTE**

The commands are only available for DHO914S and DHO924S.

3.5.1 :BODeploit:ENABLE

Syntax

```
:BODeploit:ENABLE <bool>
```

```
:BODeploit:ENABLE?
```

Description

Sets or queries the on/off status of the bode plot.

Parameter

Name	Type	Range	Default
<bool>	Bool	{{1 ON}}{0 OFF}}	0 OFF

Remarks

N/A

Return Format

The query returns 1 or 0.

Examples

```
:BODeplot:ENABle ON /*Enables the bode plot.*/
:BODeplot:ENABle? /*The query returns 1.*/
```

3.5.2 :BODeplot:RUNStop**Syntax**

```
:BODeplot:RUNStop <bool>
```

```
:BODeplot:RUNStop?
```

Description

Sets or queries the run/stops status of the bode plot.

Parameter

Name	Type	Range	Default
<bool>	Bool	{{1 ON}}{0 OFF}}	0 OFF

Remarks

N/A

Return Format

The query returns 1 or 0.

Example

```
:BODeplot:RUNStop ON /*Starts the bode plot drawing.*/
:BODeplot:RUNStop? /*The query returns 1.*/
```

3.5.3 :BODEplot:SWEEptype

Syntax

```
:BODEplot:SWEEptype <type>
:BODEplot:SWEEptype?
```

Description

Sets or queries the sweep type of the bode plot.

Parameter

Name	Type	Range	Default
<type>	Discrete	{LOG LINE}	LOG

Remarks

- **LOG:** logarithmic sweep, indicating that the frequency of the swept sine wave varies logarithmically with the time.
- **LINE:** linear sweep, indicating that the frequency of the swept sine wave varies linearly with the time.

Return Format

The query returns LOG or LINE.

Example

```
:BODEplot:SWEEptype LINE /*Sets the sweep type of the bode plot
to Linear.*/
:BODEplot:SWEEptype? /*The query returns LINE.*/
```

3.5.4 :BODEplot:REF:IN

Syntax

```
:BODEplot:REF:IN <source>
:BODEplot:REF:IN?
```

Description

Sets or queries the input source of the bode plot.

Parameter

Name	Type	Range	Default
<source>	Discrete	{CHANnel1 CHANnel2 CHANnel3 CHANnel4}	CHANnel1

Remarks

N/A

Return Format

The query returns CHANnel1, CHANnel2, CHANnel3, or CHANnel4.

Example

```
:BODEplot:REF:IN CHANnel1 /*Sets the input source of the bode plot
to CH1.*/
:BODEplot:REF:IN? /*The query returns CHANnel1.*/
```

3.5.5 :BODEplot:REF:OUT

Syntax

```
:BODEplot:REF:OUT <source>
```

```
:BODEplot:REF:OUT?
```

Description

Sets or queries the output source of the bode plot.

Parameter

Name	Type	Range	Default
<source>	Discrete	{CHANnel1 CHANnel2 CHANnel3 CHANnel4}	CHANnel1

Remarks

N/A

Return Format

The query returns CHANnel1, CHANnel2, CHANnel3, or CHANnel4.

Example

```
:BODEplot:REF:OUT CHANnel1 /*Sets the output source of the bode
plot to CH1.*/
:BODEplot:REF:OUT? /*The query returns CHANnel1.*/
```

3.5.6 :BODEplot:START

Syntax

```
:BODEplot:START <freq>
```

```
:BODEplot:START?
```

Description

Sets or queries the start frequency of the sweep signal for the Bode plot function. The default unit is Hz.

Parameter

Name	Type	Range	Default
<freq>	Real	10 Hz to 24.99 MHz	10 Hz

Remarks

The "Start Frequency" must be smaller than the "Stop Frequency". You can use `:BODEplot:STOP` to set or query the stop frequency of the sweep signal.

Return Format

The query returns the start frequency in scientific notation. The unit is Hz.

Example

```
:BODEplot:START 100 /*Sets the start frequency to 100 Hz.*/
:BODEplot:START? /*The query returns 1.000000E+2.*/
```

3.5.7 :BODEplot:STOP

Syntax

```
:BODEplot:STOP <freq>
```

```
:BODEplot:STOP?
```

Description

Sets or queries the stop frequency of the sweep signal for the Bode plot function. The default unit is Hz.

Parameter

Name	Type	Range	Default
<freq>	Real	100 Hz to 25 MHz	100 Hz

Remarks

The "Stop Frequency" should be greater than the "Start Frequency". You can use `:BODEplot:START` to set or query the start frequency of the sweep signal.

Return Format

The query returns the stop frequency in scientific notation. The unit is Hz.

Example

```
:BODEplot:STOP 500 /*Sets the stop frequency to 500 Hz.*/
:BODEplot:STOP? /*The query returns 5.000000E+2.*/
```

3.5.8 :BODEplot:POINTs

Syntax

```
:BODEplot:POINTs <num>
```

```
:BODEplot:POINTs?
```

Description

Sets or queries the number of points per decade.

Parameter

Name	Type	Range	Default
<num>	Integer	10 to 300	10

Remarks

N/A

Return Format

The query returns an integer.

Example

```
:WAVEform:POINTs 20 /*Sets the number of points per decade to 20.*/
:WAVEform:POINTs? /*The query returns 20.*/
```

3.5.9 :BODEplot:VOLTage

Syntax

```
:BODEplot:VOLTage <range>,<amp;gt;
```

```
:BODEplot:VOLTage? <range>
```

Description

Sets or queries the voltage amplitude of the sweep signal within the specified frequency range for the Bode plot function. The default unit is V for voltage and Hz for frequency.

Parameter

Name	Type	Range	Default
<amp;gt;	Real	20 mV to 5 V	-
<range>	Discrete	{ALL 10 100 1K 10K 100K 1M 10M 25M 1000 10000 100000 1000000 10000000 25000000}	-

Name	Type	Range	Default
		1e1 1e2 1e3 1e4 1e5 1e6 1e7 2.5e7}	

Remarks

- When <range> is set to ALL, it sets a uniform voltage amplitude for the sweep signals in all frequency ranges. The voltage amplitude of the sweep signal cannot be changed.
- When <range> is set to other parameter, the voltage amplitude of the sweep signal can be modified. You can set a voltage amplitude for the sweep signal whose frequency is greater than the selected value.

Return Format

The query returns the voltage amplitude of the sweep signal within the specified frequency range in scientific notation. The unit is V.

Example

```
:BODeplot:VOLTage 100,0.2 /*Sets the voltage amplitude of the
sweep signal whose frequency is greater than 100 Hz to 200 mV.*/
:BODeplot:VOLTage? 100 /*The query returns 2.000000E-1.*/
```

3.6 :CHANnel<n> Commands

The **:CHANnel<n>** commands are used to set or query the bandwidth limit, coupling, vertical scale, vertical offset, and other vertical system parameters of the analog channel.

- Setting the bandwidth limit can reduce the noises in the displayed waveforms. For example, the signal under test is a pulse with high frequency oscillation. When the bandwidth limit is turned off, the high frequency components of the signal under test can pass the channel. When the bandwidth limit is turned on, the high frequency components found in the signal under test that are greater than the limit are attenuated.
- You can remove unwanted signals by setting the coupling mode. For example, the signal under test is a square waveform with DC offset. AC coupling mode can block the DC components.

- When you use an oscilloscope to make actual measurements, a small offset that arises from the temperature drift of the component or external environment disturbance may occur on the zero-cross voltage of the channel, which will affect the measurement results of the vertical parameters. This series oscilloscope allows you to set an offset calibration voltage for calibrating the zero point of the corresponding channel so as to improve the accuracy of the measurement results.
- When the fine adjustment is enabled, you can further adjust the vertical scale within a relatively smaller range to improve vertical resolution, making it easier to view waveform details.

3.6.1 :CHANnel<n>:BWLimit

Syntax

```
:CHANnel<n>:BWLimit <val>
```

```
:CHANnel<n>:BWLimit?
```

Description

Sets or queries the bandwidth limit of the specified channel.

Parameter

Name	Type	Range	Default
<n>	Discrete	{1 2 3 4}	-
<val>	Discrete	Refer to <i>Remarks</i>	OFF

Remarks

This series oscilloscope supports the 20 MHz bandwidth limit.

When set to OFF, the bandwidth limit is disabled.

Return Format

The query returns 20M or OFF.

Example

```
:CHANnel1:BWLimit 20M /*Enables the 20MHz bandwidth limit.*/
:CHANnel1:BWLimit? /*The query returns 20M.*/
```

3.6.2 :CHANnel<n>:COUPling

Syntax

```
:CHANnel<n>:COUPling <coupling>
```

```
:CHANnel<n>:COUPling?
```

Description

Sets or queries the coupling mode of the specified channel.

Parameter

Name	Type	Range	Default
<n>	Discrete	{1 2 3 4}	-
<coupling>	Discrete	{AC DC GND}	DC

Description

- **AC:** the DC components of the signal under test are blocked.
- **DC:** both DC and AC components of the signal under test can pass through the channel.
- **GND:** both DC and AC components of the signal under test are blocked.

Return Format

The query returns AC, DC, or GND.

Example

```
:CHANnel1:COUPling AC /*Selects the AC coupling mode.*/
:CHANnel1:COUPling? /*The query returns AC.*/
```

3.6.3 :CHANnel<n>:DISPlay

Syntax

```
:CHANnel<n>:DISPlay <bool>
```

```
:CHANnel<n>:DISPlay?
```

Description

Enables or disables the specified channel; or queries the on/off status of the specified channel.

Parameter

Name	Type	Range	Default
<n>	Discrete	{1 2 3 4}	-
<bool>	Bool	{{1 ON}}{0 OFF}}	1 ON

Remarks

N/A

Return Format

The query returns 1 or 0.

Example

```
:CHANnel1:DISPlay ON /*Enables CHANnel1.*/
:CHANnel1:DISPlay? /*The query returns 1.*/
```

3.6.4 :CHANnel<n>:INVert**Syntax**

```
:CHANnel<n>:INVert <bool>
```

```
:CHANnel<n>:INVert?
```

Description

Turns on or off the waveform invert for the specified channel; or queries the on/off status of the waveform invert for the specified channel.

Parameter

Name	Type	Range	Default
<n>	Discrete	{1 2 3 4}	-
<bool>	Bool	{{1 ON}}{0 OFF}}	0 OFF

Remarks

When the waveform invert is turned off, the waveform is displayed normally; when the waveform invert is turned on, the voltage values of the displayed waveform are inverted.

Return Format

The query returns 1 or 0.

Example

```
:CHANnel1:INVert ON /*Enables the waveform invert for CH1.*/
:CHANnel1:INVert? /*The query returns 1.*/
```

3.6.5 :CHANnel<n>:OFFSet

Syntax

```
:CHANnel<n>:OFFSet <offset>
```

```
:CHANnel<n>:OFFSet?
```

Description

Sets or queries the vertical offset of the specified channel. The default unit is V.

Parameter

Name	Type	Range	Default
<n>	Discrete	{1 2 3 4}	-
<offset>	Real	Refer to <i>Remarks</i>	0 V

Remarks

The range of the vertical offset of the specified channel is related to the current vertical scale.

- ± 0.5 V (<500 μ V/div)
- ± 1 V (≥ 500 μ V/div, ≤ 65 mV/div)
- ± 8 V (65.01 mV/div, ≤ 260 mV/div)
- ± 20 V (260.01 mV/div, ≤ 2.65 V/div)
- ± 100 V (2.6501 V/div, ≤ 10 V/div)

You can run the `:CHANnel<n>:SCALE` command to set or query the vertical scale of the specified channel.

Return Format

The query returns the vertical offset in scientific notation.

Example

```
:CHANnel1:OFFSet 0.01 /*Sets the vertical offset of CH1 to 10
mV.*/
:CHANnel1:OFFSet? /*The query returns 1.000000E-02.*/
```

3.6.6 :CHANnel<n>:TCALibrate

Syntax

```
:CHANnel<n>:TCALibrate <val>
```

```
:CHANnel<n>:TCALibrate?
```

Description

Sets or queries the delay calibration time (used to calibrate the zero offset of the corresponding channel) of the specified channel. The unit is s.

Parameter

Name	Type	Range	Default
<n>	Discrete	{1 2 3 4}	-
<val>	Real	-100 ns to 100 ns	0 s

Remarks

When the horizontal time base is greater than 10 μ s, the parameter <val> cannot be set.

Return Format

The query returns the delay calibration time in scientific notation.

Example

```
:CHANnel1:TCALibrate 0.00000002 /*Sets the delay calibration time
to 20 ns.*/
:CHANnel1:TCALibrate? /*The query returns 2.000000E-8.*/
```

3.6.7 :CHANnel<n>:SCALE**Syntax**

```
:CHANnel<n>:SCALE <scale>
```

```
:CHANnel<n>:SCALE?
```

Description

Sets or queries the vertical scale of the specified channel. The default unit is V/div.

Parameter

Name	Type	Range	Default
<n>	Discrete	{1 2 3 4}	-
<scale>	Real	Refer to <i>Remarks</i>	50mV

Remarks

The range of the vertical scale of the specified channel is related to the probe ratio.

- For the DHO800 series: when the probe ratio is 1X, the value of <scale> is from 500 μ V/div to 10 V/div.

- For the DHO900 series: when the probe ratio is 1X, the value of <scale> is from 200 $\mu\text{V}/\text{div}$ to 10 V/div .

You can run the `:CHANnel<n>:PROBe` command to set or query the probe ratio of the specified channel.

Return Format

The query returns the vertical scale in scientific notation. The unit is V/div .

Example

```
:CHANnel1:SCALE 0.1 /*Sets the vertical scale of CH1 to 0.1 V/
div.*/
:CHANnel1:SCALE? /*The query returns 1.000000E-01.*/
```

3.6.8 :CHANnel<n>:PROBe

Syntax

```
:CHANnel<n>:PROBe <atten>
```

```
:CHANnel<n>:PROBe?
```

Description

Sets or queries the probe ratio of the specified channel.

Parameter

Name	Type	Range	Default
<n>	Discrete	{1 2 3 4}	-
<atten>	Discrete	{0.001 0.002 0.005 0.01 0.02 0.05 0.1 0.2 0.5 1 2 5 10 20 50 100 200 500 1000 2000 5000 10000 20000 50000}	1

Remarks

- The command sets the probe ratio, that is, multiplies the acquired signal by a specified number (not affect the actual amplitude of the signal).
- The set probe ratio affects the settable range of the current vertical scale.

Return Format

The query returns 0.001, 0.002, 0.005, 0.01, 0.02, 0.05, 0.1, 0.2, 0.5, 1, 2, 5, 10, 20, 50, 100, 200, 500, 1000, 2000, 5000, 10000, 20000, or 50000.

Example

```
:CHANnel1:PROBe 10 /*Sets the probe ratio of CH1 to 10X*/
:CHANnel1:PROBe? /*The query returns 10.*/
```

3.6.9 :CHANnel<n>:LABel:SHOW**Syntax**

```
:CHANnel<n>:LABel:SHOW <bool>
```

```
:CHANnel<n>:LABel:SHOW?
```

Description

Sets or queries whether to display the label of the specified channel.

Parameter

Name	Type	Range	Default
<n>	Discrete	{1 2 3 4}	-
<bool>	Bool	{{1 ON}}{0 OFF}}	-

Remarks

N/A

Return Format

The query returns 1 or 0.

Example

```
:CHANnel1:LABel:SHOW ON /*Displays the label of the
specified channel.*/
:CHANnel1:LABel:SHOW? /*The query returns 1.*/
```

3.6.10 :CHANnel<n>:LABel:CONTent**Syntax**

```
:CHANnel<n>:LABel:CONTent <str>
```

```
:CHANnel<n>:LABel:CONTent?
```

Description

Sets or queries the label of the specified channel.

Parameter

Name	Type	Range	Default
<n>	Discrete	{1 2 3 4}	-

Name	Type	Range	Default
<str>	ASCII String	The label can contain English letters and numbers, as well as some symbols.	-

Remarks

N/A

Return Format

The query returns the label of the specified channel in strings.

Example

```
:CHANnel1:LABel:CONTent ch1 /*Sets the label of Channel 1 to ch1.*/
:CHANnel1:LABel:CONTent? /*The query returns ch1.*/
```

3.6.11 :CHANnel<n>:UNITs

Syntax

```
:CHANnel<n>:UNITs <units>
```

```
:CHANnel<n>:UNITs?
```

Description

Sets or queries the amplitude display unit of the specified analog channel.

Parameter

Name	Type	Range	Default
<n>	Discrete	{1 2 3 4}	-
<units>	Discrete	{WATT AMPere VOLTage UNKNown}	VOLTage

Remarks

N/A

Return Format

The query returns VOLT, WATT, AMP, or UNKN.

Example

```
:CHANnel1:UNITs VOLTage /*Sets the amplitude display unit of CH1 to VOLTage.*/
:CHANnel1:UNITs? /*The query returns VOLT.*/
```

3.6.12 :CHANnel<n>:VERNier

Syntax

```
:CHANnel<n>:VERNier <bool>
```

```
:CHANnel<n>:VERNier?
```

Description

Enables or disables the fine adjustment of the vertical scale of the specified channel; or queries the on/off status of the fine adjustment of the vertical scale of the specified channel.

Parameter

Name	Type	Range	Default
<n>	Discrete	{1 2 3 4}	-
<bool>	Bool	{{1 ON}}{0 OFF}}	0 OFF

Remarks

N/A

Return Format

The query returns 1 or 0.

Example

```
:CHANnel1:VERNier ON /*Enables the fine adjustment of the
vertical scale of CH1.*/
:CHANnel1:VERNier? /*The query returns 1.*/
```

3.6.13 :CHANnel<n>:POSition

Syntax

```
:CHANnel<n>:POSition <offset>
```

```
:CHANnel<n>:POSition?
```

Description

Sets or queries the bias voltage of the specified channel. The default unit is V.

Parameter

Name	Type	Range	Default
<n>	Discrete	{1 2 3 4}	-
<offset>	Real	Refer to <i>Remarks</i>	0

Remarks

The range of the bias voltage of the specified channel is related to the vertical scale.

- ± 0.5 V (<500 μ V/div)
- ± 1 V (500 μ V/div to 65 mV/div)
- ± 8 V (65.01 mV/div to 260 mV/div)
- ± 20 V (260.01 mV/div to 2.65 V/div)
- ± 100 V (2.6501 V/div to 10 V/div)

You can run the `:CHANnel<n>:SCALE` command to set or query the vertical scale of the specified channel.

Return Format

The query returns the bias voltage of the specified channel in scientific notation. The unit is V.

Example

```
:CHANnel1:POSition 10 /*Sets the bias voltage of CH1 to 10 V.*/
:CHANnel1:POSition? /*The query returns 1.000000E +01.*/
```

3.7 :COUNter Commands

:COUNter commands are used to set or query the measurement and statistic parameters for the frequency counter.

The frequency counter analysis function provides frequency, period, or edge event counter measurements on any analog channel.

3.7.1 :COUNter:CURRent?

Syntax

```
:COUNter:CURRent?
```

Description

Queries the measurement value of the frequency counter.

Parameter

N/A

Remarks

N/A

Return Format

The query returns the current measurement value of the frequency counter in scientific notation.

Example

N/A

3.7.2 :COUNter:ENABLE**Syntax**

```
:COUNter:ENABle <bool>
```

```
:COUNter:ENABle?
```

Description

Enables or disables the frequency counter; or queries the on/off status of the frequency counter.

Parameter

Name	Type	Range	Default
<bool>	Bool	{{1 ON}}{0 OFF}}	0 OFF

Remarks

N/A

Return Format

The query returns 1 or 0.

Example

```
:COUNter:ENABle ON /*Enables the frequency counter.*/
:COUNter:ENABle? /*The query returns 1.*/
```

3.7.3 :COUNter:SOURce**Syntax**

```
:COUNter:SOURce <source>
```

```
:COUNter:SOURce?
```

Description

Sets or queries the source of the frequency counter.

Parameter

Name	Type	Range	Default
<source>	Discrete	{D0 D1 D2 D3 D4 D5 D6 D7 D8 D9 D10 D11 D12 D13 D14 D15 CHANnel1 CHANnel2 CHANnel3 CHANnel4 EXT}	CHANnel1

Remarks

Digital channels (D0 to D15) are only supported by the DHO900 series.

EXT is only available for DHO812 and DHO802.

Return Format

The query returns D0, D1, D2, D3, D4, D5, D6, D7, D8, D9, D10, D11, D12, D13, D14, D15, CHAN1, CHAN2, CHAN3, CHAN4, or EXT.

Example

```
:COUNter:SOURce CHANnel2 /*Sets the source of the frequency counter to CHANnel2.*/
:COUNter:SOURce? /*The query returns CHAN2.*/
```

3.7.4 :COUNter:MODE**Syntax**

```
:COUNter:MODE <mode>
```

```
:COUNter:MODE?
```

Description

Sets or queries the mode of the frequency counter.

Parameter

Name	Type	Range	Default
<mode>	Discrete	{FREQuency PERiod TOTAlize}	FREQuency

Remarks

- **FREQuency:** indicates the Frequency measurement.
- **PERiod:** indicates the Period measurement.
- **TOTAlize:** indicates the Totalize measurement.

Return Format

The query returns FREQ, PER, or TOT.

Example

```
:COUNTER:MODE PERiod /*Sets the mode of the frequency counter
to PERiod.*/
:COUNTER:MODE? /*The query returns PER.*/
```

3.7.5 :COUNTER:NDIGits**Syntax**

```
:COUNTER:NDIGits <val>
```

```
:COUNTER:NDIGits?
```

Description

Sets or queries the resolution of the frequency counter.

Parameter

Name	Type	Range	Default
<val>	Integer	3 to 6	4

Remarks

When the measurement mode of the frequency counter is Period or Frequency, you need to set resolution. When the mode is Totalize, resolution is available to set. You can run the `:COUNTER:MODE` command to set or query the measurement mode of the frequency counter.

Return Format

The query returns an integer ranging from 3 to 6.

Example

```
:COUNTER:NDIGits 4 /*Sets the resolution of the frequency
counter to 4.*/
:COUNTER:NDIGits? /*The query returns 4.*/
```

3.7.6 :COUNTER:TOTALize:ENABLE**Syntax**

```
:COUNTER:TOTALize:ENABLE <bool>
```

```
:COUNTER:TOTALize:ENABLE?
```

Description

Enables or disables the statistical function of the frequency counter; or queries the on/off status of the statistical function of the frequency counter.

Parameter

Name	Type	Range	Default
<bool>	Bool	{{1 ON}}{0 OFF}}	0 OFF

Remarks

The statistical function is only available for "Period" and "Frequency", but it is unavailable for "Totalize". You can use `:COUNTER:MODE` to query or set the measurement mode.

Return Format

The query returns 1 or 0.

Examples

```
:COUNTER:TOTALize:ENABLE ON /*Enables the statistical function of
the frequency counter.*/
:COUNTER:TOTALize:ENABLE? /*The query returns 1.*/
```

3.7.7 :COUNTER:TOTALize:CLEAr

Syntax

```
:COUNTER:TOTALize:CLEAr
```

Description

Clears the total count.

Parameter

N/A

Remarks

Available when "Totalize", "Frequency", or "Period" is selected under "Measure".

Return Format

N/A

Example

N/A

3.8 :CURSOR Commands

The **Cursor** commands are used to measure the X axis values (e.g. Time) and Y axis values (e.g. Voltage) of the waveform on the screen.

Before making cursor measurements, connect the signal to the oscilloscope to acquire stable display. The cursor measurement function provides the following two cursors.

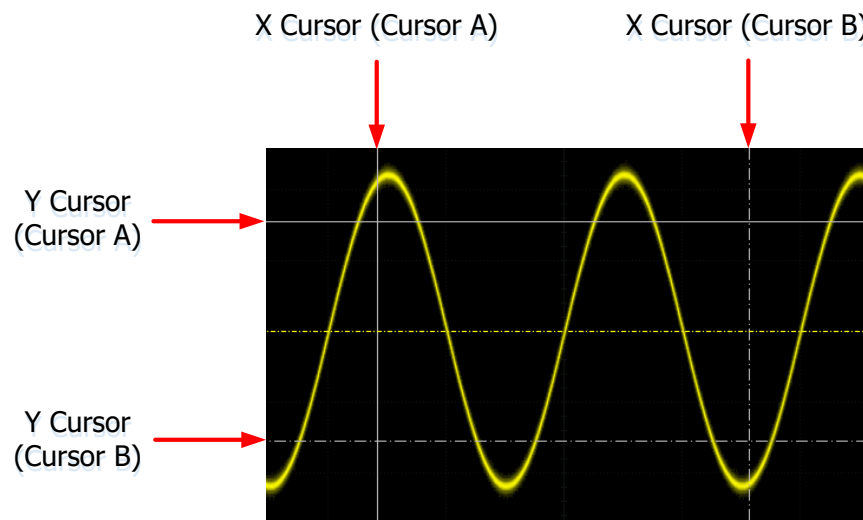

Figure 3.6 Cursors

- **X Cursor**

X cursor is a vertical solid/dotted line that is used to make horizontal adjustments. It can be used to measure time (s) and frequency (Hz).

 - Cursor A is a vertical solid line and Cursor B is a vertical dotted line.
 - In the XY cursor mode, cursor X is used to measure the waveform amplitude of CH1.
- **Y Cursor**

Y cursor is a horizontal solid/dotted line that is used to make vertical adjustments. It can be used to measure amplitude (the unit is the same as that of the source channel amplitude).

 - Cursor A is a horizontal solid line and Cursor B is a horizontal dotted line.
 - In XY cursor mode, cursor Y is used to measure the waveform amplitude of CH2.

Cursor Measurement Results

- AX: indicates the X value at Cursor A.
- AY: indicates the Y value at Cursor A.
- BX: indicates the X value at Cursor B.

- BY: indicates the Y value at Cursor B.
- ΔX : indicates the horizontal spacing between Cursor A and Cursor B.
- ΔY : indicates the vertical spacing between Cursor A and Cursor B.
- $1/\Delta X$: indicates the reciprocal of the horizontal spacing between Cursor A and Cursor B.

Cursor Mode

- **Manual Mode**

In the manual cursor mode, you can adjust the cursor manually to measure the value of the waveforms of the specified source at the current cursor. If the settings for the parameter such as the cursor type and measurement source are different, the measurement results will be different for cursor measurement.

- **Track Mode**

In the Track mode, you can adjust the two pairs of cursors (Cursor A and Cursor B) to measure the X and Y values on two different sources respectively. When the cursors are moved horizontally/vertically, the markers will position on the waveform automatically. When the waveform is expanded or compressed horizontally/vertically, the markers will track the points being marked at the last adjustment of the cursors.

- **XY Mode**

By default, XY mode is unavailable. It is available only when the horizontal time base mode is "XY".

3.8.1 :CURSOR:MODE

Syntax

:CURSOR:MODE <mode>

:CURSOR:MODE?

Description

Sets or queries the mode of the cursor measurement.

Parameter

Name	Type	Range	Default
<mode>	Discrete	{OFF MANual TRACK XY}	OFF

Remarks

- **OFF:** disables the cursor measurement function.
- **MANual:** the manual mode of cursor measurement.
- **TRACK:** the track mode of cursor measurement.
- **XY:** the XY mode of cursor measurement. It is only valid when you select "XY" mode. You can use `:TIMebase:MODE` to query or set the mode.

For functions of different cursor measurement modes, refer to *Cursor Mode*.

Return Format

The query returns OFF, MAN, TRAC, or XY.

Example

```
:CURSor:MODE MANual /*Selects the manual mode of cursor
measurement.*/
:CURSor:MODE? /*The query returns MAN.*/
```

3.8.2 :CURSor:MEASure:INDicator

Syntax

```
:CURSor:MEASure:INDicator <bool>
```

```
:CURSor:MEASure:INDicator?
```

Description

Sets or queries the on/off status of the indicator for the measurement function.

Parameter

Name	Type	Range	Default
<bool>	Bool	{{1 ON}}{0 OFF}}	0 OFF

Remarks

N/A

Return Format

The query returns 0 or 1.

Example

```
:CURSor:MEASure:INDicator? ON /*Sets the indicator for the
measurement function to ON.*/
:CURSor:MEASure:INDicator? /*The query returns 1.*/
```

3.8.3 :CURSor:MANual

3.8.3.1 :CURSor:MANual:TYPE

Syntax

```
:CURSor:MANual:TYPE <type>
```

```
:CURSor:MANual:TYPE?
```

Description

Sets or queries the cursor type in the manual mode of cursor measurement.

Parameter

Name	Type	Range	Default
<type>	Discrete	{TIME AMPLitude}	TIME

Remarks

- **TIME:** indicates X cursor, which is often used to measure the time parameters.
- **AMPLitude:** indicates Y cursor, which is often used to measure the voltage parameters.

Return Format

The query returns TIME or AMPL.

Example

```
:CURSor:MANual:TYPE AMPLitude /*Sets the cursor type to
AMPLitude.*/
:CURSor:MANual:TYPE? /*The query returns AMPL.*/
```

3.8.3.2 :CURSor:MANual:SOURce

Syntax

```
:CURSor:MANual:SOURce <source>
```

```
:CURSor:MANual:SOURce?
```

Description

Sets or queries the channel source of the manual mode of cursor measurement.

Parameter

Name	Type	Range	Default
<source>	Discrete	{CHANnel1 CHANnel2 CHANnel3 CHANnel4 MATH1 MATH2 MATH3 MATH4 NONE}	CHANnel1

Remarks

N/A

Return Format

The query returns CHAN1, CHAN2, CHAN3, CHAN4, MATH1, MATH2, MATH3, MATH4, or NONE.

Example

```
:CURSor:MANual:SOURce CHANnel2 /*Sets the channel source to
CHANnel2.*/
:CURSor:MANual:SOURce? /*The query returns CHAN2.*/
```

3.8.3.3 :CURSor:MANual:CAX**Syntax**

```
:CURSor:MANual:CAX <ax>
```

```
:CURSor:MANual:CAX?
```

Description

Sets or queries the horizontal position of Cursor A in the manual mode of cursor measurement.

Parameter

Name	Type	Range	Default
<ax>	Real	Refer to <i>Remarks</i>	-

Remarks

The range of the horizontal position of Cursor A is determined by the current horizontal scale and position.

Return Format

The query returns the horizontal position of Cursor A scientific notation. The unit is s.

Example

```
:CURSor:MANual:CAX 0.00000001 /*Sets the horizontal position of
Cursor A to 10 ns.**/
:CURSor:MANual:CAX? /*The query returns 1.000000E-8.*/
```

3.8.3.4 :CURSor:MANual:CAY**Syntax**

```
:CURSor:MANual:CAY <ay>
```

```
:CURSor:MANual:CAY?
```

Description

Sets or queries the vertical position of Cursor A in the manual mode of cursor measurement.

Parameter

Name	Type	Range	Default
<ay>	Real	Refer to <i>Remarks</i>	-

Remarks

The range of the vertical position of Cursor A is determined by the current vertical scale and position.

Return Format

The query returns the vertical position of Cursor A in scientific notation. The unit is V.

Example

```
:CURSor:MANual:CAY 0.1 /*Sets the vertical position of Cursor A
to 0.1 V.**/
:CURSor:MANual:CAY? /*The query returns 1.000000E-1.*/
```

3.8.3.5 :CURSor:MANual:CBX**Syntax**

```
:CURSor:MANual:CBX <bx>
```

```
:CURSor:MANual:CBX?
```

Description

Sets or queries the horizontal position of Cursor B in the manual mode of cursor measurement.

Parameter

Name	Type	Range	Default
<bx>	Real	Refer to <i>Remarks</i>	-

Remarks

The range of the horizontal position of Cursor B is determined by the current horizontal scale and position.

Return Format

The query returns the horizontal position of Cursor B in scientific notation. The unit is s.

Example

```
:CURSor:MANual:CBX 0.00000001 /*Sets the horizontal position of
Cursor B to 10 ns.*/
:CURSor:MANual:CBX? /*The query returns 1.000000E-8.*/
```

3.8.3.6**:CURSor:MANual:CBY****Syntax**

```
:CURSor:MANual:CBY <by>
```

```
:CURSor:MANual:CBY?
```

Description

Sets or queries the vertical position of Cursor B in the manual mode of cursor measurement.

Parameter

Name	Type	Range	Default
<by>	Real	Refer to <i>Remarks</i>	-

Remarks

The range of the vertical position of Cursor B is determined by the current vertical scale and position.

Return Format

The query returns the vertical position of Cursor B in scientific notation. The unit is V.

Example

```
:CURSor:MANual:CBY 0.1 /*Sets the vertical position of Cursor B
to 0.1 V.*/
:CURSor:MANual:CBY? /*The query returns 1.000000E-1.*/
```

3.8.3.7 :CURSor:MANual:AXValue?

Syntax

:CURSor:MANual:AXValue?

Description

Queries the X value at Cursor A in the manual mode of cursor measurement. The unit is determined by the horizontal unit selected for the currently corresponding channel.

Parameter

N/A

Remarks

N/A

Return Format

The query returns the X value at Cursor A in scientific notation.

Example

N/A

3.8.3.8 :CURSor:MANual:AYValue?

Syntax

:CURSor:MANual:AYValue?

Description

Queries the Y value at Cursor A in the manual mode of cursor measurement. The unit is determined by the currently selected vertical unit.

Parameter

N/A

Remarks

- The returned value is the same as the measurement value in the Cursor interface. Therefore, the unit is related to the vertical unit. When the vertical unit of cursor is set to Source, the unit of the returned value is the same as vertical unit of the channel.
- No value is returned when the cursor measurement value is invalid.

Return Format

The query returns the Y value at Cursor A in scientific notation.

Example

N/A

3.8.3.9 :CURSor:MANual:BXValue?**Syntax**

`:CURSor:MANual:BXValue?`

Description

Queries the X value at Cursor B in the manual mode of cursor measurement. The unit is determined by the currently selected horizontal unit.

Parameter

N/A

Remarks

N/A

Return Format

The query returns the X value at Cursor B in scientific notation.

Example

N/A

3.8.3.10 :CURSor:MANual:BYValue?**Syntax**

`:CURSor:MANual:BYValue?`

Description

Queries the Y value at Cursor B in the manual mode of cursor measurement. The unit is determined by the currently selected vertical unit.

Parameter

N/A

Remarks

- The returned value is the same as the measurement value in the Cursor interface. Therefore, the unit is related to the vertical unit. When the vertical

unit of cursor is set to Source, the unit of the returned value is the same as vertical unit of the channel.

- No value is returned when the cursor measurement value is invalid.

Return Format

The query returns the Y value at Cursor B in scientific notation.

Example

N/A

3.8.3.11 :CURSor:MANual:XDELta?

Syntax

```
:CURSor:MANual:XDELta?
```

Description

Queries the difference (ΔX) between the X value at Cursor A and the X value at Cursor B in the manual mode of cursor measurement. The unit is determined by the currently selected horizontal unit.

Parameter

N/A

Remarks

N/A

Return Format

The query returns the current difference in scientific notation.

Example

N/A

3.8.3.12 :CURSor:MANual:IXDelta?

Syntax

```
:CURSor:MANual:IXDelta?
```

Description

Queries the reciprocal ($1/\Delta X$) of the absolute difference between the X value at Cursor A and the X value at Cursor B in the manual mode of cursor measurement. The unit is determined by the currently selected horizontal unit.

Parameter

N/A

Remarks

N/A

Return Format

The query returns $1/\Delta X$ in scientific notation.

Example

N/A

3.8.3.13 :CURSor:MANual:YDELta?**Syntax**

```
:CURSor:MANual:YDELta?
```

Description

Queries the difference (ΔY) between the Y value at Cursor A and the Y value at Cursor B in the manual mode of cursor measurement. The unit is determined by the currently selected vertical unit.

Parameter

N/A

Remarks

N/A

Return Format

The query returns the current difference in scientific notation.

Example

N/A

3.8.4 :CURSor:TRACk**3.8.4.1 :CURSor:TRACk:SOURce1****Syntax**

```
:CURSor:TRACk:SOURce1 <source>
```

```
:CURSor:TRACk:SOURce1?
```

Description

Sets or queries the channel source of Cursor A in the track mode of cursor measurement.

Parameter

Name	Type	Range	Default
<source>	Discrete	{CHANnel1 CHANnel2 CHANnel3 CHANnel4 MATH1 MATH2 MATH3 MATH4 NONE}	CHANnel1

Remarks

When no channel is enabled, sending this command will enable the corresponding channel.

Return Format

The query returns CHAN1, CHAN2, CHAN3, CHAN4, MATH1, MATH2, MATH3, MATH4, or NONE.

Example

```
:CURSor:TRACk:SOURce1 CHANnel2 /*Sets the channel source to
CHANnel2.*/
:CURSor:TRACk:SOURce1? /*The query returns CHAN2.*/
```

3.8.4.2 :CURSor:TRACk:SOURce2**Syntax**

```
:CURSor:TRACk:SOURce2 <source>
```

```
:CURSor:TRACk:SOURce2?
```

Description

Sets or queries the channel source of Cursor B in the track mode of cursor measurement.

Parameter

Name	Type	Range	Default
<source>	Discrete	{CHANnel1 CHANnel2 CHANnel3 CHANnel4 MATH1 MATH2 MATH3 MATH4 NONE}	CHANnel1

Remarks

When no channel is enabled, sending this command will enable the corresponding channel.

Return Format

The query returns CHAN1, CHAN2, CHAN3, CHAN4, MATH1, MATH2, MATH3, MATH4, or NONE.

Example

```
:CURSor:TRACk:SOURce2 CHANnel2 /*Sets the channel source to
CHANnel2.*/
:CURSor:TRACk:SOURce2? /*The query returns CHAN2.*/
```

3.8.4.3 :CURSor:TRACk:CAX**Syntax**

```
:CURSor:TRACk:CAX <ax>
```

```
:CURSor:TRACk:CAX?
```

Description

Sets or queries the horizontal position of Cursor A in the track mode of cursor measurement.

Parameter

Name	Type	Range	Default
<ax>	Real	Refer to <i>Remarks</i>	-

Remarks

The range of the horizontal position of Cursor A is determined by the current horizontal scale and position.

Return Format

The query returns the horizontal position of Cursor A scientific notation. The unit is s.

Example

```
:CURSor:TRACk:CAX 1.000000E-8 /*Sets the horizontal position of
Cursor A to 10 ns.*/
:CURSor:TRACk:CAX? /*The query returns 1.000000E-8.*/
```

3.8.4.4 :CURSor:TRACk:CBX**Syntax**

```
:CURSor:TRACk:CBX <bx>
```

```
:CURSor:TRACk:CBX?
```

Description

Sets or queries the horizontal position of Cursor B in the track mode of cursor measurement.

Parameter

Name	Type	Range	Default
<bx>	Real	Refer to <i>Remarks</i>	-

Remarks

The range of the horizontal position of Cursor B is determined by the current horizontal scale and position.

Return Format

The query returns the horizontal position of Cursor B in scientific notation. The unit is s.

Example

```
:CURSOR:TRACK:CBX 1.000000E-8 /*Sets the horizontal position of
Cursor B to 10 ns.*/
:CURSOR:TRACK:CBX? /*The query returns 1.000000E-8.*/
```

3.8.4.5**:CURSOR:TRACK:CAY****Syntax**

```
:CURSOR:TRACK:CAY <ay>
```

```
:CURSOR:TRACK:CAY?
```

Description

Sets or queries the vertical position of Cursor A in the track mode of cursor measurement.

Parameter

Name	Type	Range	Default
<ay>	Real	Refer to <i>Remarks</i>	-

Remarks

The range of the vertical position of Cursor A is determined by the current vertical scale and position.

Return Format

The query returns the vertical position of Cursor A in scientific notation. The unit is V.

Example

```
:CURSor:TRACk:CAY 0.1 /*Sets the vertical position of Cursor A
to 0.1 V.*/
:CURSor:TRACk:CAY? /*The query returns 1.000000E-1.*/
```

3.8.4.6 :CURSor:TRACk:CBY**Syntax**

```
:CURSor:TRACk:CBY <by>
```

```
:CURSor:TRACk:CBY?
```

Description

Sets or queries the vertical position of Cursor B in the track mode of cursor measurement.

Parameter

Name	Type	Range	Default
<by>	Real	Refer to <i>Remarks</i>	-

Remarks

The range of the vertical position of Cursor B is determined by the current vertical scale and position.

Return Format

The query returns the vertical position of Cursor B in scientific notation. The unit is V.

Example

```
:CURSor:TRACk:CBY 0.1 /*Sets the vertical position of Cursor B
to 0.1 V.*/
:CURSor:TRACk:CBY? /*The query returns 1.000000E-1.*/
```

3.8.4.7 :CURSor:TRACk:AXValue?**Syntax**

```
:CURSor:TRACk:AXValue?
```

Description

Queries the X value at Cursor A in the track mode of cursor measurement. The unit is determined by the amplitude unit selected for the currently corresponding channel.

Parameter

N/A

Remarks

N/A

Return Format

The query returns the X value at Cursor A in scientific notation.

Example

N/A

3.8.4.8 :CURSor:TRACk:AYValue?**Syntax**

```
:CURSor:TRACk:AYValue?
```

Description

Queries the Y value at Cursor A in the track mode of cursor measurement. The unit is the same as that selected for the current channel.

Parameter

N/A

Remarks

N/A

Return Format

The query returns the Y value at Cursor A in scientific notation.

Example

N/A

3.8.4.9 :CURSor:TRACk:BXValue?**Syntax**

```
:CURSor:TRACk:BXValue?
```

Description

Queries the X value at Cursor B in the track mode of cursor measurement. The unit is determined by the amplitude unit selected for the currently corresponding channel.

Parameter

N/A

Remarks

N/A

Return Format

The query returns the X value at Cursor B in scientific notation.

Example

N/A

3.8.4.10 :CURSor:TRACk:BYValue?**Syntax**

:CURSor:TRACk:BYValue?

Description

Queries the Y value at Cursor B in the track mode of cursor measurement. The unit is the same as that selected for the current channel.

Parameter

N/A

Remarks

N/A

Return Format

The query returns the Y value at Cursor B in scientific notation.

Example

N/A

3.8.4.11 :CURSor:TRACk:XDELta?**Syntax**

:CURSor:TRACk:XDELta?

Description

Queries the difference (ΔX) between the X value at Cursor A and the X value at Cursor B in the track mode of cursor measurement.

Parameter

N/A

Remarks

N/A

Return Format

The query returns the current difference in scientific notation.

Example

N/A

3.8.4.12 :CURSor:TRACk:YDELta?**Syntax**`:CURSor:TRACk:YDELta?`**Description**

Queries the difference (ΔY) between the Y value at Cursor A and the Y value at Cursor B in the track mode of cursor measurement. The unit is the same as that selected for the current channel.

Parameter

N/A

Remarks

N/A

Return Format

The query returns the current difference in scientific notation.

Example

N/A

3.8.4.13 :CURSor:TRACk:IXDELta?**Syntax**`:CURSor:TRACk:IXDELta?`**Description**

Queries the reciprocal ($1/\Delta X$) of the absolute difference between the X value at Cursor A and the X value at Cursor B in the track mode of cursor measurement. The default unit is Hz.

Parameter

N/A

Remarks

N/A

Return Format

The query returns $1/\Delta X$ in scientific notation.

Example

N/A

3.8.4.14 :CURSor:TRACk:MODE**Syntax**`:CURSor:TRACk:MODE <mode>``:CURSor:TRACk:MODE?`**Description**

Sets or queries the axis in the track mode of cursor measurement.

Parameter

Name	Type	Range	Default
<mode>	Discrete	{Y X}	-

Remarks

N/A

Return Format

The query returns Y or X.

Example

```
:CURSor:TRACk:MODE X /*Sets the axis in the track mode of
cursor measurement to X-axis.*/
:CURSor:TRACk:MODE? /*The query returns X.*/
```

3.8.5 :CURSor:XY

The **:CURSor:XY** commands are only available when the horizontal time base mode is set to XY.

3.8.5.1 :CURSor:XY:AX**Syntax**`:CURSor:XY:AX <X>``:CURSor:XY:AX?`**Description**

Sets or queries the horizontal position of Cursor A in the XY cursor measurement mode.

Parameter

Name	Type	Range	Default
<x>	Real	Refer to <i>Description</i>	-

Description

Related to the current vertical scale and vertical offset.

Return Format

The query returns the horizontal position of Cursor A in scientific notation. The unit is V.

Example

```
:CURSor:XY:AX 0.1 /*Sets the horizontal position of Cursor A to
100 mV.*/
:CURSor:XY:AX? /*The query returns 1.000000E-1.*/
```

3.8.5.2**:CURSor:XY:BX****Syntax**

```
:CURSor:XY:BX <x>
```

```
:CURSor:XY:BX?
```

Description

Sets or queries the horizontal position of Cursor B in the XY cursor measurement mode.

Parameter

Name	Type	Range	Default
<x>	Real	Refer to <i>Remarks</i>	-

Remarks

Related to the current vertical scale and vertical offset.

Return Format

The query returns the horizontal position of Cursor B in scientific notation.

Example

```
:CURSor:XY:BX 0.1 /*Sets the horizontal position of Cursor B to
100 mV.*/
:CURSor:XY:BX? /*The query returns 1.000000E-1.*/
```

3.8.5.3 :CURSor:XY:AY**Syntax**

```
:CURSor:XY:AY <y>
```

```
:CURSor:XY:AY?
```

Description

Sets or queries the vertical position of Cursor A in the XY cursor measurement mode.

Parameter

Name	Type	Range	Default
<y>	Real	Refer to <i>Description</i>	-

Description

Related to the current vertical scale and vertical offset.

Return Format

The query returns the vertical position of Cursor A in scientific notation.

Example

```
:CURSor:XY:AY 0.1 /*Sets the vertical position of Cursor A to
100 mV.*/
:CURSor:XY:AY? /*The query returns 1.000000E-1.*/
```

3.8.5.4 :CURSor:XY:BY**Syntax**

```
:CURSor:XY:BY <y>
```

```
:CURSor:XY:BY?
```

Description

Sets or queries the vertical position of Cursor B in the XY cursor measurement mode.

Parameter

Name	Type	Range	Default
<y>	Real	Refer to <i>Remarks</i>	-

Remarks

Related to the current vertical scale and vertical offset.

Return Format

The query returns the vertical position of Cursor B in scientific notation.

Example

```
:CURSor:XY:BY 0.1 /*Sets the vertical position of Cursor B to
100 mV.* /
:CURSor:XY:BY? /*The query returns 1.000000E-1.* /
```

3.8.5.5 :CURSor:XY:AXValue?**Syntax**

```
:CURSor:XY:AXValue?
```

Description

Queries the X value at Cursor A in the XY cursor measurement mode.

Parameter

N/A

Remarks

N/A

Return Format

The query returns the X value at Cursor A in scientific notation.

Example

```
N/A
```

3.8.5.6 :CURSor:XY:AYValue?**Syntax**

```
:CURSor:XY:AYValue?
```

Description

Queries the X value at Cursor A in the XY cursor measurement mode.

Parameter

N/A

Remarks

N/A

Return Format

The query returns the Y value at Cursor A in scientific notation.

Example

```
N/A
```

3.8.5.7 :CURSor:XY:BXValue?

Syntax

:CURSor:XY:BXValue?

Description

Queries the X value at Cursor B in the XY cursor measurement mode.

Parameter

N/A

Remarks

N/A

Return Format

The query returns the X value at Cursor B in scientific notation.

Example

N/A

3.8.5.8 :CURSor:XY:BYValue?

Syntax

:CURSor:XY:BYValue?

Description

Queries the Y value at Cursor B in the XY cursor measurement mode.

Parameter

N/A

Remarks

N/A

Return Format

The query returns the Y value at Cursor B in scientific notation.

Example

N/A

3.8.5.9 :CURSor:XY:XDELta?

Syntax

:CURSor:XY:XDELta?

Description

Queries the difference (ΔX) between the X value at Cursor A and the X value at Cursor B in the XY cursor measurement.

Parameter

N/A

Remarks

N/A

Return Format

The query returns the current difference in scientific notation.

Example

N/A

3.8.5.10 :CURSor:XY:YDELta?**Syntax**

:CURSor:XY:YDELta?

Description

Queries the difference (ΔY) between the Y value at Cursor A and the Y value at Cursor B in the XY cursor measurement. The unit is the same as that selected for the current channel.

Parameter

N/A

Remarks

N/A

Return Format

The query returns the current difference in scientific notation.

Example

N/A

3.9 :DISPlay Commands

The **:DISPlay** commands can be used to set the displayed type of the waveform, persistence time, intensity, grid type, grid brightness, etc.

3.9.1 :DISPlay:CLEar

Syntax

```
:DISPlay:CLEar
```

Description

Clears all the waveforms on the screen.

Parameter

N/A

Remarks

- If the oscilloscope is in the "RUN" state, new waveforms will continue being displayed after being cleared.
- You can also send the *:CLEar* command to clear all the waveforms on the screen.
- This command functions the same as the front-panel key  .

Return Format

N/A

Example

N/A

3.9.2 :DISPlay:TYPE

Syntax

```
:DISPlay:TYPE <type>
```

```
:DISPlay:TYPE?
```

Description

Sets or queries the display type of the waveforms on the screen.

Parameter

Name	Type	Range	Default
<type>	Discrete	{VECTors}	VECTors

Remarks

VECTors: The sample points are connected by lines and displayed. Normally, this mode can provide the most vivid waveform to view the steep edge of the waveform (such as square waveforms).

Return Format

The query returns VECT.

Example

```
:DISPlay:TYPE VECTors /*Sets the display type to VECTors.*/
:DISPlay:TYPE? /*The query returns VECT.*/
```

3.9.3 :DISPlay:GRADing:TIME**Syntax**

```
:DISPlay:GRADing:TIME <time>
```

```
:DISPlay:GRADing:TIME?
```

Description

Sets or queries the persistence time. The default unit is s.

Parameter

Name	Type	Range	Default
<time>	Discrete	{MIN 0.1 0.2 0.5 1 2 5 10 INFinite}	MIN

Remarks

- **MIN:** sets the persistence time to its minimum value to view how the waveform changes at a high refresh rate.
- **specified value (e.g. 0.1, 0.2, 0.5, 1, 2, 5, 10):** sets the persistence time to any of the above specific value to observe glitches that change relatively slowly or glitches with low occurrence probability.
- **INFinite:** In this mode, the oscilloscope displays the waveform newly acquired without clearing the waveforms acquired formerly. It can be used to measure noise and jitter and to capture incidental events.

Return Format

The query returns MIN, 0.1, 0.2, 0.5, 1, 2, 5, 10, or INF.

Example

```
:DISPlay:GRADing:TIME 0.1 /*Sets the persistence time to 100 ms.*/
:DISPlay:GRADing:TIME? /*The query returns 0.1.*/
```

3.9.4 :DISPlay:WBRightness

Syntax

```
:DISPlay:WBRightness <brightness>
:DISPlay:WBRightness?
```

Description

Sets or queries the brightness of the waveform on the screen, expressed in percentage.

Parameter

Name	Type	Range	Default
<brightness>	Integer	1 to 100	50

Remarks

N/A

Return Format

The query returns an integer ranging from 1 to 100.

Example

```
:DISPlay:WBRightness 50 /*Sets the waveform brightness to 50%*/
:DISPlay:WBRightness? /*The query returns 50.*/
```

3.9.5 :DISPlay:GRID

Syntax

```
:DISPlay:GRID <grid>
:DISPlay:GRID?
```

Description

Sets or queries the display type of the screen grid.

Parameter

Name	Type	Range	Default
<grid>	Discrete	{FULL HALF NONE}	FULL

Remarks

- **FULL:** turns the background grid and coordinates on.
- **HALF:** turns the background grid off and turns the coordinate on.

- **NONE:** turns the background grid and coordinate off.

Return Format

The query returns FULL, HALF, or NONE.

Example

```
:DISPlay:GRID NONE /*Turns the background grid and coordinates
off.*/
:DISPlay:GRID? /*The query returns NONE.*/
```

3.9.6 :DISPlay:GBrightness

Syntax

```
:DISPlay:GBrightness <brightness>
```

```
:DISPlay:GBrightness?
```

Description

Sets or queries the brightness of the screen grid, expressed in percentage.

Parameter

Name	Type	Range	Default
<brightness>	Integer	0 to 100	50

Remarks

N/A

Return Format

The query returns an integer ranging from 0 to 100.

Example

```
:DISPlay:GBrightness 60 /*Sets the screen grid brightness to
60%.*/
:DISPlay:GBrightness? /*The query returns 60.*/
```

3.9.7 :DISPlay:DATA?

Syntax

```
:DISPlay:DATA? [<type>]
```

Description

Queries the bitmap data stream of the currently displayed image.

Parameter

Name	Type	Range	Default
<type>	Discrete	{BMP PNG JPG}	BMP

Remarks

The read data format is TMC header + binary data stream of the screenshot + terminator. The TMC header is in #NXXXXXX format; wherein, # is the TMC header identifier; N following # represents the number of digits (in the decimal integer) that follow; the length of the binary data stream of the screenshot is expressed in ASCII strings, and the terminator represents the ending of communication. For example, the data read for one time is #9000387356. 9 indicates the number of digits (in the decimal integer) that follow, and "000387356" indicates the length of the binary data stream, that is, the number of bytes to be transmitted.

Return Format

The query returns the binary data stream of the screenshot in format.

Example

N/A

3.9.8 :DISPlay:RULers**Syntax**

`:DISPlay:RULers <bool>`

`:DISPlay:RULers?`

Description

Enables or disables the display of the scale ruler; or queries the on/off status of the scale ruler.

Parameter

Name	Type	Range	Default
<bool>	Bool	{{1 ON}}{0 OFF}}	1 ON

Remarks

N/A

Return Format

The query returns 1 or 0.

Example

```
:DISPlay:RULers ON /*Enables the display of the scale ruler.*/
:DISPlay:RULers? /*The query returns 1.*/
```

3.9.9 :DISPlay:COLor**Syntax**

```
:DISPlay:COLor <bool>
```

```
:DISPlay:COLor?
```

Description

Enables or disables the color grade display; or queries the on/off status of the color grade display.

Parameter

Name	Type	Range	Default
<bool>	Bool	{{1 ON}}{0 OFF}}	0 OFF

Remarks

When it is enabled, different colors are displayed on the screen to indicate the times of data acquisition or acquisition probability.

Return Format

The query returns 1 or 0.

Examples

```
:DISPlay:COLor ON /*Enables the color grade display.*/
:DISPlay:COLor? /*The query returns 1.*/
```

3.9.10 :DISPlay:WHOLD**Syntax**

```
:DISPlay:WHOLD <bool>
```

```
:DISPlay:WHOLD?
```

Description

Sets to enable or disable the waveform freezing function; queries whether to enable or disable the waveform freezing function.

Parameter

Name	Type	Range	Default
<bool>	Bool	{{1 ON}}{0 OFF}}	0 OFF

Remarks

N/A

Return Format

The query returns 1 or 0.

Example

```
:DISPlay:WHOLd ON /*Enables the Waveform Freeze.*/  
:DISPlay:WHOLd? /*The query returns 1.*/
```

3.10 :DVM Commands

:DVM commands are used to set or query the DVM parameters.

The built-in DVM of this oscilloscope provides 4-digit voltage measurements on any analog channel. DVM measurements are asynchronous from the oscilloscope's acquisition system and are always acquiring.

3.10.1 :DVM:CURRent?

Syntax

```
:DVM:CURRent?
```

Description

Queries the current voltage value under test.

Parameter

N/A

Remarks

N/A

Return Format

N/A

Example

N/A

3.10.2 :DVM:ENABLE

Syntax

```
:DVM:ENABLE <bool>
```

```
:DVM:ENABLE?
```

Description

Enables or disables the digital voltmeter; or queries the on/off status of the digital voltmeter.

Parameter

Name	Type	Range	Default
<bool>	Bool	{{1 ON}} {{0 OFF}}	0 OFF

Remarks

N/A

Return Format

The query returns 1 or 0.

Example

```
:DVM:ENABLE ON /*Enables the digital voltmeter.*/
:DVM:ENABLE? /*The query returns 1.*/
```

3.10.3 :DVM:SOURce**Syntax**

```
:DVM:SOURce <source>
```

```
:DVM:SOURce?
```

Description

Sets or queries the source of the digital voltmeter.

Parameter

Name	Type	Range	Default
<source>	Discrete	{CHANnel1 CHANnel2 CHANnel3 CHANnel4}	CHANnel1

Remarks

N/A

Return Format

The query returns CHAN1, CHAN2, CHAN3, or CHAN4.

Example

```
:DVM:SOURce CHANnel1 /*Sets the source of DVM to CHANnel1.*/
:DVM:SOURce? /*The query returns CHAN1.*/
```

3.10.4 :DVM:MODE

Syntax

```
:DVM:MODE <mode>
```

```
:DVM:MODE?
```

Description

Sets or queries the mode of digital voltmeter.

Parameter

Name	Type	Range	Default
<mode>	Discrete	{ACRMs DC DCRMs}	ACRMs

Remarks

- **ACRMs:** displays the root-mean-square value of the acquired data, with the DC component removed.
- **DC:** displays the root- average-square value of the acquired data.
- **DCRMs:** displays the root-mean-square value of the acquired data.

Return Format

The query returns ACRM, DC, or DCRM.

Example

```
:DVM:MODE DC /*Sets the mode of the digital voltmeter to DC.*/
:DVM:MODE? /*The query returns DC.*/
```

3.11 :HISTogram Commands

This histogram analysis function provides a diagram of the statistics on the waveforms or its measurement results, enabling you to judge the trend of waveforms, and quickly locate the potential abnormalities of the signal.

NOTE

Only the DHO900 series supports the histogram analysis function.

Histogram Analysis Results

The statistical results of the histogram analysis include the following items.

- **Sum:** indicates the sum of all bins (buckets) in the histogram.

- Peaks: indicates the maximum number of hits in any single bin.
- Max: indicates the maximum value.
- Min: indicates the minimum value.
- Pk_Pk: indicates the Delta (Max-Min) between the max. value and the min. value.
- Mean: indicates the average value of the histogram.
- Median: indicates the median value of the histogram.
- Mode: indicates the mode value of the histogram.
- Bin width: indicates the width of each bin (bucket) in the histogram.
- Sigma: indicates the standard deviation of the histogram.
- XScale: indicates the horizontal scale of the histogram. It is 100 times the value of Bin width.

3.11.1 :HISTogram:ENABLE

Syntax

```
:HISTogram:ENABLE <bool>
```

```
:HISTogram:ENABLE?
```

Description

Enables or disables the histogram function; or queries the on/off status of the histogram.

Parameter

Name	Type	Range	Default
<bool>	Bool	{{1 ON}} {{0 OFF}}	0 OFF

Remarks

N/A

Return Format

The query returns 1 or 0.

Examples

```
:HISTogram:ENABLE ON /*Enables the histogram function.*/
:HISTogram:ENABLE? /*The query returns 1.*/
```

3.11.2 :HISTogram:TYPE

Syntax

```
:HISTogram:TYPE <type>
```

```
:HISTogram:TYPE?
```

Description

Sets or queries the type of the histogram.

Parameter

Name	Type	Range	Default
<type>	Discrete	{HORizontal VERTical}	VERTical

Remarks

- **HORizontal:** horizontal histogram.
- **VERTical:** vertical histogram.

Return Format

The query returns HOR or VERT.

Example

```
:HISTogram:TYPE VERTical /*Sets the histogram type to Vertical.*/
:HISTogram:TYPE? /*The query returns VERT.*/
```

3.11.3 :HISTogram:SOURce

Syntax

```
:HISTogram:SOURce <source>
```

```
:HISTogram:SOURce?
```

Description

Sets or queries the source of the histogram.

Parameter

Name	Type	Range	Default
<source>	Discrete	{CHANnel1 CHANnel2 CHANnel3 CHANnel4}	CHANnel1

Remarks

N/A

Return Format

The query returns CHAN1, CHAN2, CHAN3, CHAN4.

Example

```
:HISTogram:SOURce CHANnel2 /*Sets the source of the histogram to
CH2.*/*
:HISTogram:SOURce? /*The query returns CHAN2.*/*
```

3.11.4 :HISTogram:HEIGht**Syntax**

```
:HISTogram:HEIGht <height>
```

```
:HISTogram:HEIGht?
```

Description

Sets or queries the height of the histogram.

Parameter

Name	Type	Range	Default
<height>	Integer	1div to 4div	2div

Remarks

N/A

Return Format

The query returns an integer ranging from 1 to 4.

Example

```
:HISTogram:HEIGht 2 /*Sets the histogram height to 2.*/*
:HISTogram:HEIGht? /*The query returns 2.*/*
```

3.11.5 :HISTogram:RANGe:LEFT**Syntax**

```
:HISTogram:RANGe:LEFT <number>
```

```
:HISTogram:RANGe:LEFT?
```

Description

Sets or queries the left limit of the histogram.

Parameter

Name	Type	Range	Default
<number>	Real	(-5 x Horizontal Time Base + Horizontal Offset) to (5 x Horizontal Time Base + Horizontal Offset)	-

Remarks

- The left limit should be smaller than the right limit. You can use `:HISTogram:RANGe:RIGHT` to set or query the right limit of the histogram.
- You can use `:TIMebase[:MAIN]:SCALE` to set or query the horizontal time base.
- You can use `:TIMebase[:MAIN]:OFFSet` to set or query the horizontal offset.

Return Format

The query returns the left limit in scientific notation.

Example

```
:HISTogram:RANGe:LEFT -2 /*Sets the left limit of the histogram
to -2 s.*/
:HISTogram:RANGe:LEFT? /*The query returns -2.000000E0.*/
```

3.11.6 :HISTogram:RANGe:RIGHT

Syntax

```
:HISTogram:RANGe:RIGHT <number>
```

```
:HISTogram:RANGe:RIGHT?
```

Description

Sets or queries the right limit of the histogram.

Parameter

Name	Type	Range	Default
<number>	Real	(-5 x Horizontal Time Base + Horizontal Offset) to (5 x Horizontal Time Base + Horizontal Offset)	-

Remarks

- The right limit should be greater than the left limit. You can use `:HISTogram:RANGe:LEFT` to set or query the left limit of the histogram.
- You can use `:TIMEbase[:MAIN]:SCALE` to set or query the horizontal time base.
- You can use `:TIMEbase[:MAIN]:OFFSet` to set or query the horizontal offset.

Return Format

The query returns the right limit in scientific notation.

Example

```
:HISTogram:RANGe:RIGHT 2 /*Sets the right limit of the histogram
to 2 s.*/
:HISTogram:RANGe:RIGHT? /*The query returns 2.000000E0.*/
```

3.11.7 :HISTogram:RANGe:TOP

Syntax

`:HISTogram:RANGe:TOP <number>`

`:HISTogram:RANGe:TOP?`

Description

Sets or queries the top limit of the histogram.

Parameter

Name	Type	Range	Default
<number>	Real	(-4 x VerticalScale - OFFSet) to (4 x VerticalScale - OFFSet)	-

Remarks

- The top limit should be greater than the bottom limit. You can use `:HISTogram:RANGe:BOTTom` to set or query the bottom limit of the histogram.
- You can use `:CHANnel<n>:SCALE` to set or query the vertical scale for the specified channel.
- You can use `:CHANnel<n>:OFFSet` to set or query the vertical offset for the specified channel.

Return Format

The query returns the top limit in scientific notation.

Example

```
:HISTogram:RANGe:TOP -2 /*Sets the top limit of the histogram to
-2 V.*/
:HISTogram:RANGe:TOP? /*The query returns -2.000000E0.*/
```

3.11.8 :HISTogram:RANGe:BOTTom**Syntax**

```
:HISTogram:RANGe:BOTTom <number>
```

```
:HISTogram:RANGe:BOTTom?
```

Description

Sets or queries the bottom limit of the histogram.

Parameter

Name	Type	Range	Default
<number>	Real	(-4 x VerticalScale - OFFSet) to (4 x VerticalScale - OFFSet)	-

Remarks

- The bottom limit should be smaller than the top limit. You can use `:HISTogram:RANGe:TOP` to set or query the top limit of the histogram.
- You can use `:CHANnel<n>:SCALE` to set or query the vertical scale for the specified channel.
- You can use `:CHANnel<n>:OFFSet` to set or query the vertical offset for the specified channel.

Return Format

The query returns the bottom limit in scientific notation.

Example

```
:HISTogram:RANGe:BOTTom -2 /*Sets the bottom limit of the
histogram to -2 V.*/
:HISTogram:RANGe:BOTTom? /*The query returns -2.000000E0.*/
```

3.11.9 :HISTogram:STATistics:RESult?

Syntax

```
:HISTogram:STATistics:RESult?
```

Description

Queries the statistical results of the histogram.

Parameter

N/A

Remarks

N/A

Return Format

The query returns the results in the following strings.

```
[Sum:5.6khits,Peaks:14hits,Max:3.9us,Min:-4us,Pk_Pk:7.98us,Mean:-20ns,Median:-20ns,Mode:-4us,Bin width:20ns,Sigma:2.303us]
```

For details, refer to [Histogram Analysis Results](#).

Example

N/A

3.12 IEEE488.2 Common Commands

The IEEE488.2 common commands are used to query the basic information of the instrument or executing basic operations. These commands usually start with "*", and the command keywords contain 3 characters and are related with status registers.

The standard event status register (SESR) and status byte register (SBR) record the event of a certain type happened during the use of the instrument. IEEE488.2 defines to record one specific type of event for each bit in the status register.

Table 3.128 Table of the Bit Definition of Standard Event Status Register

Bit No.	Bit Name	Decimal Value	Description
0	Operation Complete (OPC)	1	"Operation complete" indicates that all pending operations were completed following the execution of the command.
1	Not Used	2	-

Bit No.	Bit Name	Decimal Value	Description
2	Query Error (QYE)	4	The instrument tries to read the output buffer but it was empty. Or, a new command line was received before a previous query has been read. Or, both the input buffer and output buffer are full.
3	Device-Specific Error (DDE)	8	Indicates that an error has occurred that is neither a Command Error, a Query Error, nor an Execution Error. A Device-Specific Error is any executed device operation that did not properly complete due to some condition, such as self-check error, calibration error, or other device-specific errors.
4	Execution Error (E)	16	An execution error occurred.
5	Command Error (CME)	32	A command error (command syntax error) has occurred.
6	Not Used	64	-
7	Power On (PON)	128	Indicates that an off-to-on transition has occurred in the device's power supply since last reading or the event register was cleared.

Table 3.129 Table of the Bit Definition of Status Byte Register

Bit No.	Bit Name	Decimal Value	Description
0	Not Used	1	-
1	Not Used	2	-
2	Error Queue	4	1 or multiple errors in the error queue
3	Questionable Data Summary	8	Sets 1 or multiple bits (must be the enabled bit) in the questionable data register.

Bit No.	Bit Name	Decimal Value	Description
4	Message Available (MAV)	16	Indicates the available data in the output buffer.
5	Standard Event Summary	32	Sets 1 or multiple bits (must be the enabled bit) in the standard event register.
6	Master Summary Status (MSS)	64	Sets 1 or multiple bits (must be the enabled bit) in the Status Byte Register and generate the service request.
7	Operation Status Register	128	Sets 1 or multiple bits (must be the enabled bit) in the Operation Status Register.

3.12.1 *IDN?

Syntax

*IDN?

Description

Queries the ID string of the instrument.

Parameter

N/A

Remarks

N/A

Return Format

The query returns RIGOL TECHNOLOGIES,<model>,<serial number>,<software version>.

- **<model>**: indicates the model number of the instrument.
- **<serial number>**: indicates the serial number of the instrument.
- **<software version>**: indicates the software version of the instrument.

Example

N/A

3.12.2 *RST

Syntax

*RST

Description

Restores the instrument to its factory default settings.

Parameter

N/A

Remarks

N/A

Return Format

N/A

Example

N/A

3.12.3 *CLS

Syntax

*CLS

Description

Clears all the event registers, and also clears the error queue.

Parameter

N/A

Remarks

N/A

Return Format

N/A

Example

N/A

3.12.4 *ESE

Syntax

*ESE <maskargument>

ESE?*Description**

Sets or queries the enable register of the standard event register set.

Parameter

Name	Type	Range	Default
<maskargument>	Integer	0 to 255	0

Remarks

For the definitions of the bits in the standard event register, refer to [Table 3.128 Table of the Bit Definition of Standard Event Status Register](#). The value of <maskargument> is the sum of the decimal values of all bits set in the standard event register. For example, to enable Bit 2 (4 in decimal), Bit 3 (8 in decimal), and Bit 7 (128 in decimal), set the <maskargument> to 140 (4+8+128).

Return Format

The query returns an integer. The integer equals to the decimal-weighted sum of all the bits set in the register.

Example

```
*ESE 16 /*Enables Bit 4 (16 in decimal) in the register.*/
*ESE? /*The query returns the enable value of the register 16.*/
```

3.12.5 *ESR?**Syntax*****ESR?****Description**

Queries and clears the event register of the standard event status register.

Parameter

N/A

Remarks

Bit 1 and Bit 6 in the standard event status register ([Table 3.128 Table of the Bit Definition of Standard Event Status Register](#)) are not used and are always treated as 0; therefore, the range of the returned value is a decimal number corresponding to a binary number X0XXXX0X (X is 1 or 0).

Return Format

The query returns an integer. The integer equals to the binary-weighted sum of all the bits set in the register.

Example

N/A

3.12.6 *OPC**Syntax*****OPC*****OPC?****Description**

The *OPC command sets bit 0 (Operation Complete, OPC) in the standard event register to 1 after the current operation is finished.

The *OPC? command queries whether the current operation is finished.

Parameter

N/A

Remarks

For the definitions of the bits in the standard event register, refer to [Table 3.128 Table of the Bit Definition of Standard Event Status Register](#).

Return Format

The query returns 1 after the current operation is finished; otherwise, the query returns 0.

Example

N/A

3.12.7 *RCL**Syntax*****RCL****Description**

Recalls instrument settings from the specified non-volatile memory. The previous saved settings through the ***SAV** command will be overwritten.

Parameter

N/A

Remarks

N/A

Return Format

N/A

Example

N/A

3.12.8 *SAV**Syntax**`*SAV <value>`**Description**

Saves the current instrument state to the selected register.

Parameter

Name	Type	Range	Default
<value>	Integer	0 to 49	0

Remarks

N/A

Return Format

N/A

Example`*SAV 1 /*Saves the current instrument state to Register 1.*/`**3.12.9 *SRE****Syntax**`*SRE <maskargument>``*SRE?`**Description**

Sets or queries the enable register of the status byte register set.

Parameter

Name	Type	Range	Default
<maskargument>	Integer	0 to 255	0

Remarks

For the definitions of the bits in the status byte register, refer to *Table 3.129 Table of the Bit Definition of Status Byte Register*. The value of <maskargument> is the sum of the decimal values of all bits set in the status byte register. For example, to enable Bit 2 (4 in decimal), Bit 3 (8 in decimal), and Bit 7 (128 in decimal), set the <maskargument> to 140 (4+8+128).

Return Format

The query returns an integer. The integer equals to the decimal-weighted sum of all the bits set in the register.

Example

```
*SRE 16 /*Enables Bit 4 (16 in decimal) in the register.*/
*SRE? /*The query returns the enable value of the register 16.*/
```

3.12.10 *STB?**Syntax**

***STB?**

Description

Queries the event register for the status byte register. After executing the command, the value in the status byte register is cleared.

Parameter

N/A

Remarks

Bit 0 and Bit 1 in the status byte register (*Table 3.129 Table of the Bit Definition of Status Byte Register*) are not used and are always treated as 0; therefore, the range of the returned value is a decimal number corresponding to a binary number XXXXXX00 (X is 1 or 0).

Return Format

The query returns an integer. The integer equals to the decimal-weighted sum of all the bits set in the register.

Example

N/A

3.12.11 *WAI**Syntax**

***WAI**

Description

Waits for all the pending operations to complete before executing any additional commands.

Parameter

N/A

Remarks

This operation command does not have any functions, only to be compatible with other devices.

Return Format

N/A

Example

N/A

3.12.12 *TST?

Syntax

*TST?

Description

Performs a self-test and returns the self-test result.

Parameter

N/A

Remarks

This command executes a self-test. If the test fails, one or more error messages will be displayed, providing more information. You can use `:SYSTEM:ERROR[:NEXT]?` to read the error queue.

Return Format

The query returns 0 or 1.

- **0**: it passes.
- **1**: one or more tests fail.

Example

N/A

3.13 :LA Commands

:LA (logic analyzer) commands are used to perform relevant operations on the digital channels.

The oscilloscope compares the voltages acquired in each sample with the preset logic threshold. If the voltage of the sample point is above the threshold, it will be stored as logic 1; otherwise, it will be store as logic 0. The oscilloscope displays the logic levels (1s and 0s) in a graphic way for you to easily detect and analyze the errors in circuit design (hardware design and software design).



NOTE

The DHO800 series oscilloscope does not support this command.

3.13.1 :LA:ENABLE

Syntax

```
:LA:ENABle <bool>
```

```
:LA:ENABle?
```

Description

Enables or disables LA; or queries the LA on/off status.

Parameter

Name	Type	Range	Default
<bool>	Bool	{{1 ON}} {{0 OFF}}	0 OFF

Remarks

N/A

Return Format

The query returns 1 or 0.

Examples

```
:LA:ENABle ON /*Enables the LA function.*/  
:LA:ENABle? /*The query returns 1.*/
```

3.13.2 :LA:ACTIVE

Syntax

```
:LA:ACTive <digital>
```

```
:LA:ACTive?
```

Description

Sets or queries the current active channel.

Parameter

Name	Type	Range	Default
<digital>	Discrete	{D0 D1 D2 D3 D4 D5 D6 D7 D8 D9 D10 D11 D12 D13 D14 D15 NONE}	D0

Remarks

- The parameter <digital> can be any of the digital channels (D0-D15). The channel label and waveform of the selected channel are displayed in red.
- When you send the parameter NONE, it means that no channel is selected.
- Only the currently enabled digital channel can be selected. Please refer to [:LA:DIGital:ENABle](#) to enable the desired channel.

Return Format

The query returns D0, D1, D2, D3, D4, D5, D6, D7, D8, D9, D10, D11, D12, D13, D14, D15, or NONE.

Example

```
:LA:ACTive D3 /*Sets the current active channel to D3.*/
:LA:ACTive? /*The query returns D3.*/
```

3.13.3 :LA:AUTosort**Syntax**

```
:LA:AUTosort <val>
```

```
:LA:AUTosort?
```

Description

Sets the auto sorting mode for the waveforms of the enabled channels.

Parameter

Name	Type	Range	Default
<val>	Discrete	{D0D15 D15D0}	D15D0

Remarks

- **D0D15:** the waveforms on the display are D0-D15 in sequence from top to bottom.
- **D15D0:** the waveforms on the display are D15-D0 in sequence from top to bottom.

Return Format

The query returns D0D15 or D15D0.

Example

```
:LA:AUTosort D0D15 /*Sets the auto sorting mode to D0D15.*/  
:LA:AUTosort? /*The query returns D0D15.*/*
```

3.13.4 :LA:DELeTe**Syntax**

```
:LA:DELeTe <group>
```

Description

Cancels the group settings for the channel groups (GROUp1-GROUp4).

Parameter

Name	Type	Range	Default
<group>	Discrete	{GROUp1 GROUp2 GROUp3 GROUp4}	-

Remarks

This command only performs the canceling operation for digital channels or user-defined channel group that have been group set.

Return Format

N/A

Example

```
N/A
```

3.13.5 :LA:DIgital:ENABle**Syntax**

```
:LA:DIgital:ENABle <digital>,<bool>
```

```
:LA:DIgital:ENABle? <digital>
```

Description

Enables or disables the specified digital channel; or queries the on/off status of the specified digital channel.

Parameter

Name	Type	Range	Default
<digital>	Discrete	{D0 D1 D2 D3 D4 D5 D6 D7 D8 D9 D10 D11 D12 D13 D14 D15}	-
<bool>	Bool	{{1 ON}}{0 OFF}}	0 OFF

Remarks

You can use *:LA:ACTive* to select the currently enabled channels.

Return Format

The query returns 1 or 0.

Examples

```
:LA:DIGital:ENABle D3,ON /*Enables D3.*/
:LA:DIGital:ENABle? D3 /*The query returns 1.*/
```

3.13.6 :LA:DIGital:LABel**Syntax**

```
:LA:DIGital:LABel <digital>,<label>
```

```
:LA:DIGital:LABel? <digital>
```

Description

Sets or queries the label of the specified digital channel.

Parameter

Name	Type	Range	Default
<digital>	Discrete	{D0 D1 D2 D3 D4 D5 D6 D7 D8 D9 D10 D11 D12 D13 D14 D15}	-
<label>	ASCII String	It can contain English letters and numbers, and also some symbols.	-

Remarks

N/A

Return Format

The query returns the label of the specified digital channel in ASCII strings.

Example

```
:LA:DIGital:LABel D0,ACK /*Sets the label of D0 to ACK.*/
:LA:DIGital:LABel? D0 /*The query returns ACK.*/
```

3.13.7 :LA:POD<n>:DISPlay**Syntax**

```
:LA:POD<n>:DISPlay <bool>
```

```
:LA:POD<n>:DISPlay?
```

Description

Enables or disables the specified default channel group, or queries the on/off status of the specified default channel group.

Parameter

Name	Type	Range	Default
<n>	Integer	1 to 2	-
<bool>	Bool	{{1 ON}} {{0 OFF}}	0 OFF

Remarks

2 default channel groups: POD1 (D0 to D7) and POD2 (D8 to D15).

Return Format

The query returns 1 or 0.

Example

```
:LA:POD1:DISPlay 1 /*Enables POD1 (D0 to D7).*/
:LA:POD1:DISPlay? /*The query returns 1.*/
```

3.13.8 :LA:POD<n>:THReshold**Syntax**

```
:LA:POD<n>:THReshold <thre>
```

```
:LA:POD<n>:THReshold?
```

Description

Sets or queries the threshold of the specified default channel group. The default unit is V.

Parameter

Name	Type	Range	Default
<n>	Integer	1 to 2	-
<thre>	Real	-20.0 V to +20.0 V	1.40 V

Remarks

2 default channel groups: POD1 (D0 to D7) and POD2 (D8 to D15).

Return Format

The query returns the current threshold of the specified channel group in scientific notation.

Example

```
:LA:POD1:THReshold 3.3 /*Sets the threshold of POD1 (D0 to D7)
to 3.3 V.*/
:LA:POD1:THReshold? /*The query returns 3.300000E0.*/
```

3.13.9 :LA:SIZE**Syntax**

```
:LA:SIZE <size>
```

```
:LA:SIZE?
```

Description

Sets or queries the size of the waveforms of the enabled channel on the screen.

Parameter

Name	Type	Range	Default
<size>	Discrete	{SMAL LARGe MEDIum}	MEDIum

Remarks

L (large) can only be used when the number of the currently enabled channels is no more than 8.

Return Format

The query returns SMAL, LARG, or MED.

Example

```
:LA:SIZE SMALl /*Sets the waveform display size to SMALl.*/
:LA:SIZE? /*The query returns SMAL.*/
```

3.14 :LAN Commands

The **:LAN** commands are used to set or query the LAN-related parameters.



NOTE

After configuring all the other **:LAN** commands, you need to send **:LAN:APPLY** to make all the LAN configurations take effect.

3.14.1 :LAN:DHCP

Syntax

```
:LAN:DHCP <bool>
```

```
:LAN:DHCP?
```

Description

Turns on or off the DHCP configuration mode; or queries the on/off status of the current DHCP configuration mode.

Parameter

Name	Type	Range	Default
<bool>	Bool	{{1 ON}} {{0 OFF}}	1 ON

Remarks

- When the three IP configuration types (DHCP, Auto IP, and Static IP) are all turned on, the priority of the parameter configuration from high to low is "DHCP", "Auto IP", and "Static IP". The three IP configuration types cannot be all turned off at the same time.
- When DHCP is valid, the DHCP server in the current network will assign the network parameters (such as the IP address) for the oscilloscope.
- After the **:LAN:APPLY** command is executed, the configuration type can take effect immediately.

Return Format

The query returns 1 or 0.

Example

```
:LAN:DHCP OFF /*Disables DHCP configuration mode.*/
:LAN:DHCP? /*The query returns 0.*/
```

3.14.2 :LAN:AUTOip

Syntax

```
:LAN:AUTOip <bool>
```

```
:LAN:AUTOip?
```

Description

Turns on or off the Auto IP configuration mode; or queries the on/off status of the current Auto IP configuration mode.

Parameter

Name	Type	Range	Default
<bool>	Bool	{{1 ON}} {{0 OFF}}	1 ON

Remarks

When the auto IP mode is valid, disable DHCP manually. You can self-define the gateway and DNS address for the oscilloscope.

Return Format

The query returns 1 or 0.

Example

```
:LAN:AUTOip OFF          /*Disables the Auto IP configuration
mode.*/*
:LAN:AUTOip?             /*The query returns 0.*/*
```

3.14.3 :LAN:GATeway

Syntax

```
:LAN:GATeway <string>
```

```
:LAN:GATeway?
```

Description

Sets or queries the default gateway.

Parameter

Name	Type	Range	Default
<string>	ASCII String	Refer to <i>Remarks</i>	-

Remarks

- The format of <string> is nnn.nnn.nnn.nnn. The range of the first section of "nnn" is from 0 to 223 (except 127), and the ranges of the other three sections of "nnn" are from 0 to 255.
- When you use this command, the IP configuration mode should be Auto IP or Static IP mode.

Return Format

The query returns the current gateway in strings.

Example

```
:LAN:GATeway 192.168.1.1 /*Sets the default gateway to
192.168.1.1.*/*
:LAN:GATeway? /*The query returns 192.168.1.1.*/*
```

3.14.4 :LAN:DNS**Syntax**

```
:LAN:DNS <string>
```

```
:LAN:DNS?
```

Description

Sets or queries the DNS address.

Parameter

Name	Type	Range	Default
<string>	ASCII String	Refer to <i>Remarks</i>	-

Remarks

- The format of <string> is nnn.nnn.nnn.nnn. The range of the first section of "nnn" is from 0 to 223 (except 127), and the ranges of the other three sections of "nnn" are from 0 to 255.
- When you use this command, the IP configuration mode should be Auto IP or Static IP mode.

Return Format

The query returns the current DNS address in strings.

Example

```
:LAN:DNS 192.168.1.1 /*Sets the DNS address to
192.168.1.1.*/
:LAN:DNS? /*The query returns 192.168.1.1.*/
```

3.14.5 :LAN:MAC?**Syntax**

```
:LAN:MAC?
```

Description

Queries the MAC address of the instrument.

Parameter

N/A

Remarks

N/A

Return Format

The query returns the MAC address in strings. For example, 00:19:AF:00:11:22.

Example

N/A

3.14.6 :LAN:DSERver?**Syntax**

```
:LAN:DSERver?
```

Description

Queries the address of the DHCP server.

Parameter

N/A

Remarks

N/A

Return Format

The query returns the address of the DHCP server in strings.

Example

N/A

3.14.7 :LAN:MANual

Syntax

```
:LAN:MANual <bool>
```

```
:LAN:MANual?
```

Description

Turns on or off the static IP configuration mode; or queries the on/off status of the static IP configuration mode.

Parameter

Name	Type	Range	Default
<bool>	Bool	{{1 ON}} {{0 OFF}}	0 OFF

Remarks

When the static IP mode is valid, disable DHCP and Auto IP manually. You can self-define the network parameters of the oscilloscope, such as IP address, subnet mask, gateway, and DNS address. For the setting of the IP address, refer to the [:LAN:IPADdress](#) command. For the setting of the subnet mask, refer to the [:LAN:SMASK](#) command. For the setting of the gateway, refer to the [:LAN:GATeway](#) command. For the setting of DNS, refer to the [:LAN:DNS](#) command.

Return Format

The query returns 1 or 0.

Example

```
:LAN:MANual ON /*Enables the static IP configuration mode.*/
:LAN:MANual? /*The query returns 1.*/
```

3.14.8 :LAN:IPADdress

Syntax

```
:LAN:IPADdress <string>
```

```
:LAN:IPADdress?
```

Description

Sets or queries the IP address of the instrument.

Parameter

Name	Type	Range	Default
<string>	ASCII String	Refer to Remarks	-

Remarks

- The format of <string> is nnn.nnn.nnn.nnn. The range of the first section of "nnn" is from 0 to 223 (except 127), and the ranges of the other three sections of "nnn" are from 0 to 255.
- When you use the command, the IP configuration mode should be static IP. Besides, the DHCP and auto IP should be disabled.

Return Format

The query returns the current IP address in strings.

Example

```
:LAN:IPADdress 192.168.1.10 /*Sets the IP address to
192.168.1.10.*/
:LAN:IPADdress? /*The query returns 192.168.1.10.*/
```

3.14.9 :LAN:SMASK**Syntax**

:LAN:SMASK <string>

:LAN:SMASK?

Description

Sets or queries the subnet mask.

Parameter

Name	Type	Range	Default
<string>	ASCII String	Refer to <i>Remarks</i>	-

Remarks

- The format of <string> is nnn.nnn.nnn.nnn. The range of the section "nnn" is from 0 to 255.
- When you use the command, the IP configuration mode should be static IP. Besides, the DHCP and auto IP should be disabled.

Return Format

The query returns the current subnet mask in strings.

Example

```
:LAN:SMASK 255.255.255.0 /*Sets the subnet mask to  
255.255.255.0.*/  
:LAN:SMASK? /*The query returns 255.255.255.0.*/
```

3.14.10 :LAN:STATus?

Syntax

```
:LAN:STATus?
```

Description

Queries the current network configuration status.

Parameter

N/A

Remarks

- **UNLINK:** not connected.
- **CONNECTED:** the network is successfully connected.
- **INIT:** the instrument is acquiring an IP address.
- **IPCONFLICT:** there is an IP address conflict.
- **BUSY:** please wait...
- **CONFIGURED:** the network configuration has been successfully configured.
- **DHCPFAILED:** the DHCP configuration has failed.
- **INVALIDIP:** invalid IP.
- **IPLOSE:** IP lost.

Return Format

The query returns UNLINK, CONNECTED, INIT, IPCONFLICT, BUSY, CONFIGURED, DHCPFAILED, INVALIDIP, or IPLOSE.

Example

```
N/A
```

3.14.11 :LAN:VISA?

Syntax

```
:LAN:VISA? [<type>]
```

Description

Queries the VISA address of the instrument.

Parameter

Name	Type	Range	Default
<type>	Discrete	{USB LXI SOCKET}	-

Remarks

This command contains a parameter "type" and it is used to set or query the address type. By default, it returns the LXI address.

Return Format

The query returns the VISA address in strings.

Example

N/A

3.14.12 :LAN:MDNS**Syntax**

```
:LAN:MDNS <bool>
```

```
:LAN:MDNS?
```

Description

Enables or disables mDNS; or queries the mDNS status.

Parameter

Name	Type	Range	Default
<bool>	Bool	{{1 ON}}{0 OFF}}	0 OFF

Remarks

N/A

Return Format

The query returns 1 or 0.

Example

```
:LAN:MDNS ON /*Enables mDNS.*/
:LAN:MDNS? /*The query returns 1.*/
```

3.14.13 :LAN:HOST:NAME

Syntax

:LAN:HOST:NAME <name>

:LAN:HOST:NAME?

Description

Sets or queries the host name.

Parameter

Name	Type	Range	Default
<name>	ASCII String	The label can contain English letters and numbers, as well as some symbols.	-

Remarks

N/A

Return Format

The query returns the host name in ASCII strings.

Example

N/A

3.14.14 :LAN:DESCRiption

Syntax

:LAN:DESCRiption <name>

:LAN:DESCRiption?

Description

Sets or queries the description.

Parameter

Name	Type	Range	Default
<name>	ASCII String	The label can contain English letters and numbers, as well as some symbols.	-

Remarks

N/A

Return Format

The query returns the description in ASCII strings.

Example

N/A

3.14.15 :LAN:APPLy

Syntax

:LAN:APPLy

Description

Applies the network configuration.

Parameter

N/A

Remarks

After configuring all the LAN-related parameters with the :LAN commands, you need to send this command to make all the LAN configurations take effect.

Return Format

N/A

Example

N/A

3.15 :MASK Commands

:MASK commands are used to set or query the pass/fail test related parameters.

During the product design and manufacturing process, you usually need to monitor the variations of the signal or judge whether the product is up to standard. The standard pass/fail test function of this series oscilloscope can accomplish this task perfectly. You can use this function to set the test rules based on standard waveforms and define the mask. It compares the signal under test with the mask and displays the test results.

3.15.1 :MASK:ENABLE

Syntax

:MASK:ENABLe <bool>

:MASK:ENABLe?

Description

Enables or disables the pass/fail test function; or queries the on/off status of the pass/fail test function.

Parameter

Name	Type	Range	Default
<bool>	Bool	{{1 ON}}{0 OFF}}	0 OFF

Remarks

The pass/fail test is disabled in the following conditions:

- When the horizontal time base is in ROLL mode; (to set or query the horizontal time base mode, run *:TIMebase:MODE*.)
- When the delayed sweep mode (Zoom) is enabled; (to set or query the on/off status of the delayed sweep, run *:TIMebase:DELAy:ENABLe*.)
- When performing the waveform recording and playing.

Return Format

The query returns 1 or 0.

Example

```
:MASK:ENABLe ON /*Enables the pass/fail test function.*/
:MASK:ENABLe? /*The query returns 1.*/
```

3.15.2 :MASK:SOURce**Syntax**

```
:MASK:SOURce <SOURCE>
```

```
:MASK:SOURce?
```

Description

Sets or queries the source of the pass/fail test.

Parameter

Name	Type	Range	Default
<source>	Discrete	{CHANnel1 CHANnel2 CHANnel3 CHANnel4}	CHANnel1

Remarks

When you use the command to set the disabled channel, the disabled channel will be enabled automatically.

Return Format

The query returns CHAN1, CHAN2, CHAN3, or CHAN4.

Example

```
:MASK:SOURce CHANnel2 /*Sets the source of the pass/fail test to
CHANnel2.*/
:MASK:SOURce? /*The query returns CHAN2.*/
```

3.15.3 :MASK:OPERate**Syntax**

```
:MASK:OPERate <oper>
```

```
:MASK:OPERate?
```

Description

Starts or stops the pass/fail test; or queries the operating status of the pass/fail test.

Parameter

Name	Type	Range	Default
<oper>	Discrete	{RUN STOP}	STOP

Remarks

Before running this command, send the *:MASK:ENABle* command to enable the pass/fail test function.

Return Format

The query returns RUN or STOP.

Example

```
:MASK:OPERate RUN /*Starts the pass/fail test.*/
:MASK:OPERate? /*The query returns RUN.*/
```

3.15.4 :MASK:X**Syntax**

```
:MASK:X <x>
```

```
:MASK:X?
```

Description

Sets or queries the horizontal adjustment parameter of the pass/fail test mask. The default unit is div.

Parameter

Name	Type	Range	Default
<x>	Real	0.01 div to 2 div	0.24 div

Remarks

N/A

Return Format

The query returns the current horizontal adjustment parameter in scientific notation.

Example

```
:MASK:X 0.28 /*Sets the horizontal adjustment parameter to 0.28
div.*/
:MASK:X? /*The query returns 2.800000E-1.*/
```

3.15.5 :MASK:Y**Syntax**

```
:MASK:Y <y>
```

```
:MASK:Y?
```

Description

Sets or queries the vertical adjustment parameter of the pass/fail test mask. The default unit is div.

Parameter

Name	Type	Range	Default
<y>	Real	0.04 div to 2 div	0.48 div

Remarks

N/A

Return Format

The query returns the current vertical adjustment parameter in scientific notation.

Example

```
:MASK:Y 0.36 /*Sets the vertical adjustment parameter to 0.36
div.*/
:MASK:Y? /*The query returns 3.600000E-1.*/
```

3.15.6 :MASK:CREate

Syntax

:MASK:CREate

Description

Creates the pass/fail test mask with the currently set horizontal and vertical adjustment parameters.

Parameter

N/A

Remarks

- This command is only valid when the pass/fail test function is enabled and not in the running state. You can use *:MASK:ENABle* to query or set the status of the pass/fail test function. You can use *:MASK:OPERate* to query or set the running status.
- You can use *:MASK:X* and *:MASK:Y* to query or set the horizontal and vertical adjustment parameters.

Return Format

N/A

Example

N/A

3.15.7 :MASK:RESet

Syntax

:MASK:RESet

Description

Resets the number of frames that passed and failed the pass/fail test, as well as the total number of frames.

Parameter

N/A

Remarks

N/A

Return Format

N/A

Example

N/A

3.15.8 :MASK:FAILED?

Syntax`:MASK:FAILED?`**Description**

Queries the total number of failed frames in the pass/fail test results.

Parameter

N/A

Remarks

N/A

Return Format

The query returns an integer.

Example

N/A

3.15.9 :MASK:PASSED?

Syntax`:MASK:PASSED?`**Description**

Queries the total number of passed frames in the pass/fail test results.

Parameter

N/A

Remarks

N/A

Return Format

The query returns an integer.

Example

N/A

3.15.10 :MASK:TOTal?**Syntax**`:MASK:TOTal?`**Description**

Queries the total number of frames in the pass/fail test results.

Parameter

N/A

Remarks

N/A

Return Format

The query returns an integer.

Example

N/A

3.15.11 :MASK:OUTPut:ENABLE**Syntax**`:MASK:OUTPut:ENABLE <bool>``:MASK:OUTPut:ENABLE?`**Description**

Sets or queries the output on/off status of the rear-panel AUX OUT connector.

Parameter

Name	Type	Range	Default
<bool>	Bool	{{1 ON}}{0 OFF}}	0 OFF

Remarks

- If enabled, in the Utility menu, "AUX Out" is automatically set to "PassFail". When a successful or failed event is detected, a pulse will be output from the **[AUX OUT]** connector.

- If disabled, in the Utility menu, "AUX Out" is automatically set to "TrigOut". The output of the [AUX OUT] connector is irrelevant with the pass/fail test.

Return Format

The query returns 0 or 1.

Example

```
:MASK:OUTPut:ENABle ON /*Enables the Aux output.*/
:MASK:OUTPut:ENABle? /*The query returns 1.*/
```

3.15.12 :MASK:OUTPut:EVENT

Syntax

```
:MASK:OUTPut:EVENT <item>
```

```
:MASK:OUTPut:EVENT?
```

Description

Sets or queries the output event.

Parameter

Name	Type	Range	Default
<item>	Discrete	{FAIL PASS}	FAIL

Remarks

N/A

Return Format

The query returns FAIL or PASS.

Example

```
:MASK:OUTPut:EVENT PASS /*Sets the output event to PASS.*/
:MASK:OUTPut:EVENT? /*The query returns PASS.*/
```

3.15.13 :MASK:OUTPut:TIME

Syntax

```
:MASK:OUTPut:TIME <time>
```

```
:MASK:OUTPut:TIME?
```

Description

Sets or queries the output pulse time.

Parameter

Name	Type	Range	Default
<time>	Real	100 ns to 10 ms	1 μ s

Remarks

N/A

Return Format

The query returns the pulse time in scientific notation.

Example

```
:MASK:OUTPut:TIME 0.000003 /*Sets the pulse time to 3  $\mu$ s.*/
:MASK:OUTPut:TIME? /*The query returns 3.000000E-6.*/
```

3.16 :MATH<n> Commands

:MATH<n> commands are used to set various math operation function of the waveform between channels.

This series oscilloscopes can realize multiple math operations between waveforms of different channels, including arithmetic operation, function operation, FFT operation, logic operation, and digital filter.

Operator**Arithmetic Operation**

The arithmetic operations supported by this oscilloscope include $A+B$, $A-B$, $A \times B$, and $A \div B$.

- **$A+B$** adds the waveform voltage values of signal source A and B point by point and displays the results.
- **$A-B$** subtracts the waveform voltage values of signal source B from that of source A point by point and displays the results.
- **$A \times B$** multiplies the waveform voltage values of signal source A and B point by point and displays the results.
- **$A \div B$** divides the waveform voltage values of signal source A by that of source B point by point and displays the results. It can be used to analyze the Multiple relation of the two channels waveforms. When the voltage of signal source B is 0 V, the division result is treated as 0.

Function Operation

The available function operation types of this oscilloscope include Intg, Diff, Sqrt, Lg (Base 10 Exponential), Ln, Exp, Abs, and AX+B.

- **Intg:** calculates the integral of the selected source. For example, you can use integral to measure the area under a waveform or the pulse energy.
- **Diff:** calculates the discrete time derivative of the selected source. For example, you can use differentiate to measure the instantaneous slope of a waveform.
- **Sqrt:** calculates the square roots of the selected source point by point and displays the results.
- **Lg (Base 10 Exponential):** calculates the base 10 exponential of the selected source point by point and displays the results.
- **Ln:** calculates the natural logarithm (Ln) of the selected source point by point and displays the results.
- **Exp:** calculates the exponential of the selected source point by point and displays the results.
- **Abs:** calculates the absolute value of the selected source and displays the results.
- **AX+B:** applies a linear function to the selected source, and displays the results.

FFT Operation

FFT (Fast Fourier Transform) is used to transform time-domain signals to frequency-domain components (frequency spectrum). This oscilloscope provides FFT operation function which enables you to observe the time-domain waveform and spectrum of the signal at the same time. FFT operation can facilitate the following works:

- Measure harmonic components and distortion in the system;
- Display the characteristics of the noise in DC power;
- Analyze vibration.

Table 3.161 Window Function

Window Function	Characteristics	Waveforms Applicable to the Window Function
Rectangular	Best frequency resolution	Transient or short pulse, the signal levels before and after the multiplication are basically the same

Window Function	Characteristics	Waveforms Applicable to the Window Function
	Poorest amplitude resolution Similar to the situation when no window is applied	Sine waveforms with the same amplitudes and rather similar frequencies Wide band random noise with relatively slow change of waveform spectrum
Blackman-Harris	Best amplitude resolution Poorest frequency resolution	Single frequency signal, searching for higher order harmonics
Hanning	Better frequency resolution and poorer amplitude resolution compared with Rectangular	Sine, periodic, and narrow band random noise
Hamming	A little bit better frequency resolution than Hanning	Transient or short pulse, the signal levels before and after the multiplication are rather different
Flattop	Measure the signals accurately	Measure the signal that has no accurate reference and requires an accurate measurement
Triangle	Better frequency resolution	Measure the narrow band signal and that has strong noise interference

Spectral leakage can be considerably minimized when a window function is used. The oscilloscope provides 6 FFT window functions which have different characteristics and are applicable to measure different waveforms, as shown in the table below. You need to select the window function according to the characteristics of the waveform to be measured.

Logic Operation

The logic operations supported by this oscilloscope include $A \& B$, $A || B$, $A \wedge B$, and $!A$. The results of logic operation of one binary bit are shown in the table below:

Table 3.162 Logic Operation Results

A	B	$A \& B$	$A B$	$A \wedge B$	$!A$
0	0	0	0	0	1
0	1	0	1	1	1
1	0	0	1	1	0
1	1	1	1	0	0

Digital Filter

The digital filters supported by this oscilloscope include: low-pass filter, high-pass filter, band-pass filter, and band-stop filter.

- **LowPass** only allows the signals whose frequencies are lower than the current upper limit frequency to pass.
- **HighPass** only allows the signals whose frequencies are higher than the current lower limit frequency to pass.
- **BandPass** only allows the signals whose frequencies are higher than the current lower limit frequency and lower than the current upper limit frequency to pass.
- **BandStop** only allows the signals whose frequencies are lower than the current lower limit frequency or higher than the current upper limit frequency to pass.

3.16.1 :MATH<n>:DISPlay

Syntax

```
:MATH<n>:DISPlay <bool>
```

```
:MATH<n>:DISPlay?
```

Description

Enables or disables the math operation function; or queries the on/off status of the math operation function.

Parameter

Name	Type	Range	Default
<n>	Discrete	{1 2 3 4}	-
<bool>	Bool	{{1 ON}}{0 OFF}}	0 OFF

Remarks

N/A

Return Format

The query returns 1 or 0.

Example

```
:MATH1:DISPlay ON /*Enables the math operation of Math1.*/
:MATH1:DISPlay? /*The query returns 1.*/
```

3.16.2 :MATH<n>:OPERator

Syntax

```
:MATH<n> :OPERator <opt>
```

```
:MATH<n> :OPERator?
```

Description

Sets or queries the operator of math operation.

Parameter

Name	Type	Range	Default
<n>	Discrete	{1 2 3 4}	-
<opt>	Discrete	{ADD SUBTract MULTiply DIVision AND OR XOR NOT FFT INTG DIFF SQRT LG LN EXP ABS LPASs HPASs BPASs BSTop AXB}	ADD

Remarks

The math operation supported include A+B (ADD), A-B (SUBTract), A×B (MULTiply), A÷B (DIVision), AND, OR, XOR, NOT, FFT, INTG, DIFF, SQRT, LG (Base 10 Exponential), natural logarithm (LN), EXP, ABS, LPASs, HPASs, BPASs, BSTop, and AXB. For details, refer to *Operator*.

Return Format

The query returns ADD, SUBT, MULT, DIV, AND, OR, XOR, NOT, FFT, INTG, DIFF, SQRT, , LG, LN, EXP, ABS, LPAS, HPAS, BPAS, BST, or AXB.

Example

```
:MATH1:OPERator INTG /*Sets the math operator of Math1 to INTG.*/  
:MATH1:OPERator? /*The query returns INTG.*/
```

3.16.3 :MATH<n>:SOURce1

Syntax

```
:MATH<n> :SOURce1 <source>
```

```
:MATH<n> :SOURce1?
```

Description

Sets or queries the source or Source A of arithmetic operation/function operation/filter operation.

Parameter

Name	Type	Range	Default
<n>	Discrete	{1 2 3 4}	-
<source>	Discrete	{CHANnel1 CHANnel2 CHANnel3 CHANnel4 REF1 REF2 REF3 REF4 REF5 REF6 REF7 REF8 REF9 REF10 MATH1 MATH2 MATH3}	CHANnel1

Remarks

- When n = 1, the range of the parameter is {CHANnel1|CHANnel2|CHANnel3|CHANnel4|REF1|REF2|REF3|REF4|REF5|REF6|REF7|REF8|REF9|REF10}.
- When n = 2, the range of the parameter is {CHANnel1|CHANnel1|CHANnel2|CHANnel3|CHANnel4|REF1|REF2|REF3|REF4|REF5|REF6|REF7|REF8|REF9|REF10|MATH1}.
- When n = 3, the range of the parameter is {CHANnel1|CHANnel2|CHANnel1|CHANnel2|CHANnel3|CHANnel4|REF1|REF2|REF3|REF4|REF5|REF6|REF7|REF8|REF9|REF10|MATH1|MATH2}.
- When n = 4, the range of the parameter is {CHANnel1|CHANnel2|CHANnel3|CHANnel1|CHANnel2|CHANnel3|CHANnel4|REF1|REF2|REF3|REF4|REF5|REF6|REF7|REF8|REF9|REF10|MATH1|MATH2|MATH3}.
- For arithmetic operation, this command is used to set Source A.
- For function operation and filter operation, only use this command to set the source.
- For detailed operations, refer to the descriptions in *Operator*.

Return Format

The query returns MATH1, MATH2, MATH3, CHAN1, CHAN2, CHAN3, CHAN4, REF1, REF2, REF3, REF4, REF5, REF6, REF7, REF8, REF9, or REF10.

Example

```
:MATH1:SOURce1 CHANnel3 /*Sets Source A of the arithmetic
operation to CHANnel3.*/
:MATH1:SOURce1? /*The query returns CHAN3.*/
```

3.16.4 :MATH<n>:SOURce2

Syntax

:MATH<n> : SOURce2 <source>

:MATH<n> : SOURce2?

Description

Sets or queries Source B of arithmetic operation.

Parameter

Name	Type	Range	Default
<n>	Discrete	{1 2 3 4}	-
<source>	Discrete	{CHANnel1 CHANnel2 CHANnel3 CHANnel4 REF1 REF2 REF3 REF4 REF5 REF6 REF7 REF8 REF9 REF10 MATH1 MATH2 MATH3}	CHANnel1

Remarks

This command is only available for arithmetic operation (containing two sources). For detailed operations, refer to the descriptions in *Operator*.

- When n = 1, the range of the parameter is {CHANnel1|CHANnel2|CHANnel3|CHANnel4|REF1|REF2|REF3|REF4|REF5|REF6|REF7|REF8|REF9|REF10}.
- When n = 2, the range of the parameter is {CHANnel1|CHANnel1|CHANnel2|CHANnel3|CHANnel4|REF1|REF2|REF3|REF4|REF5|REF6|REF7|REF8|REF9|REF10|MATH1}.
- When n = 3, the range of the parameter is {CHANnel1|CHANnel2|CHANnel1|CHANnel2|CHANnel3|CHANnel4|REF1|REF2|REF3|REF4|REF5|REF6|REF7|REF8|REF9|REF10|MATH1|MATH2}.
- When n = 4, the range of the parameter is {CHANnel1|CHANnel2|CHANnel3|CHANnel1|CHANnel2|CHANnel3|CHANnel4|REF1|REF2|REF3|REF4|REF5|REF6|REF7|REF8|REF9|REF10|MATH1|MATH2|MATH3}.

Return Format

The query returns MATH1, MATH2, MATH3, CHAN1, CHAN2, CHAN3, CHAN4, REF1, REF2, REF3, REF4, REF5, REF6, REF7, REF8, REF9, or REF10.

Example

```
:MATH1:SOURce2 CHANnel3 /*Sets Source B of the arithmetic
operation to CHANnel3.*/
:MATH1:SOURce2? /*The query returns CHAN3.*/
```

3.16.5 :MATH<n>:LSOURCE1**Syntax**

```
:MATH<n> :LSOURCE1 <source>
```

```
:MATH<n> :LSOURCE1?
```

Description

Sets or queries Source A of the logic operation.

Parameter

Name	Type	Range	Default
<n>	Discrete	{1 2 3 4}	-
<source>	Discrete	{CHANnel1 CHANnel2 CHANnel3 CHANnel4 D0 D1 D2 D3 D4 D5 D6 D7 D8 D9 D10 D11 D12 D13 D14 D15}	CHANnel1

Remarks

The logic operations include A&&B, A||B, A^B, and !A.

D0-D15 are only available for the DHO900 series.

Return Format

The query returns D0, D1, D2, D3, D4, D5, D6, D7, D8, D9, D10, D11, D12, D13, D14, D15, CHAN1, CHAN2, CHAN3, or CHAN4.

Example

```
:MATH1:LSOURCE1 CHANnel3 /*Sets Source A of the logic operation
to CHANnel3.*/
:MATH1:LSOURCE1? /*The query returns CHAN3.*/
```

3.16.6 :MATH<n>:LSOURCE2**Syntax**

```
:MATH<n> :LSOURCE2 <source>
```

:MATH<n> :LSOURCE2?

Description

Sets or queries Source B of the logic operation.

Parameter

Name	Type	Range	Default
<n>	Discrete	{1 2 3 4}	-
<source>	Discrete	{CHANnel1 CHANnel2 CHANnel3 CHANnel4 D0 D1 D2 D3 D4 D5 D6 D7 D8 D9 D10 D11 D12 D13 D14 D15}	CHANnel1

Remarks

- The logic operations include $A \& B$, $A | B$, $A \wedge B$, and $\neg A$.
- This command is only available for the logic operation that contains two sources. It is used to set Source B.
- D0-D15 are only available for the DHO900 series.

Return Format

The query returns D0, D1, D2, D3, D4, D5, D6, D7, D8, D9, D10, D11, D12, D13, D14, D15, CHAN1, CHAN2, CHAN3, or CHAN4.

Example

```
:MATH1:LSOURCE2 CHANnel4 /*Sets Source B of the logic operation
to CHANnel4.*/
:MATH1:LSOURCE2? /*The query returns CHAN4.*/
```

3.16.7 :MATH<n>:SCALE

Syntax

:MATH<n> :SCALE <scale>

:MATH<n> :SCALE?

Description

Sets or queries the vertical scale of the operation results. The unit is related to the currently selected operator and the unit selected by the source.

Parameter

Name	Type	Range	Default
<n>	Discrete	{1 2 3 4}	-
<scale>	Real	Refer to <i>Remarks</i>	-

Remarks

- The setting range of the vertical scale is related to the currently selected operator and the scale of the source channel. For integration and differentiation operations, the actual range of <scale> is also related to the current horizontal time base.
- This command is invalid for logic operation and FFT operation.

Return Format

The query returns the vertical scale of the current operation results in scientific notation.

Example

```
:MATH1:SCALE 0.2 /*Sets the vertical scale to 200 mV.*/
:MATH1:SCALE? /*The query returns 2.000000E-1.*/
```

3.16.8 :MATH<n>:OFFSet**Syntax**

```
:MATH<n>:OFFSet <offset>
```

```
:MATH<n>:OFFSet?
```

Description

Sets or queries the vertical offset of the operation results. The unit is related to the currently selected operator and the unit selected by the source.

Parameter

Name	Type	Range	Default
<n>	Discrete	{1 2 3 4}	-
<offset>	Real	-1 GV to +1 GV	0.00 V

Remarks

This command is invalid for logic operation and FFT operation.

Return Format

The query returns the vertical offset of the current operation results in scientific notation.

Example

```
:MATH1:OFFSet 8 /*Sets the vertical offset to 8 V.*/
:MATH1:OFFSet? /*The query returns 8.000000E0.*/
```

3.16.9 :MATH<n>:INVert**Syntax**

```
:MATH<n>:INVert <bool>
```

```
:MATH<n>:INVert?
```

Description

Enables or disables the inverted display of the operation results; or queries the on/off status of the inverted display of the operation results.

Parameter

Name	Type	Range	Default
<n>	Discrete	{1 2 3 4}	-
<bool>	Bool	{{1 ON}} {0 OFF}}	0 OFF

Remarks

This command is invalid for FFT operation and logical operation.

Return Format

The query returns 1 or 0.

Example

```
:MATH1:INVert ON /*Enables the inverted display.*/
:MATH1:INVert? /*The query returns 1.*/
```

3.16.10 :MATH<n>:RESet**Syntax**

```
:MATH<n>:RESet
```

Description

After you send this command, the instrument will adjust the vertical scale of the operation results to an optimal value based on the currently selected operator and the horizontal time base of the source.

Parameter

N/A

Remarks

N/A

Return Format

N/A

Example

N/A

3.16.11 :MATH<n>:GRID

Syntax`:MATH<n> :GRID <grid>``:MATH<n> :GRID?`**Description**

Sets or queries the grid type of the math operation display.

Parameter

Name	Type	Range	Default
<grid>	Discrete	{FULL HALF NONE}	-

Remarks

- **FULL:** turns the background grid and coordinates on.
- **HALF:** turns the background grid off and turns the coordinate on.
- **NONE:** turns the background grid and coordinate off.

Return Format

The query returns FULL, HALF, or NONE.

Example

```
:MATH1:GRID NONE /*Turns the background grid and coordinates off.*/
:MATH1:GRID? /*The query returns NONE.*/
```

3.16.12 :MATH<n>:EXPand

Syntax`:MATH<n> :EXPand <exp>`

:MATH<n>:EXPand?

Description

Sets or queries the vertical expansion type of math operation.

Parameter

Name	Type	Range	Default
<n>	Discrete	{1 2 3 4}	-
<exp>	Discrete	{GND CENTer}	GND

Remarks

- **CENTer:** when the vertical scale is changed, the waveform will be expanded or compressed around the screen center.
- **GND:** when the vertical scale is changed, the waveform will be expanded or compressed around the signal ground level position.

Return Format

The query returns GND or CENTER.

Example

```
:MATH1:EXPand CENTER /*Sets the vertical expansion type of math
operation of CH1 to CENTER.*/
:MATH1:EXPand? /*The query returns CENTER.*/
```

3.16.13 :MATH<n>:WAVetype

Syntax

:MATH<n>:MATH<n>:WAVetype <type>

:MATH<n>:WAVetype?

Description

Sets or queries the waveform type of math operation.

Parameter

Name	Type	Range	Default
<n>	Discrete	{1 2 3 4}	-
<type>	Discrete	{MAIN ZOOM}	MAIN

Remarks

- **MAIN:** indicates the main time base region.
- **ZOOM:** indicates the zoomed time base region.

Only when the zoom function is enabled, can the Zoom waveform type be enabled. Zoom is not supported for the FFT operation.

Return Format

The query returns MAIN or ZOOM.

Example

```
:MATH1:WAVetype ZOOM /*Sets the waveform type of math operation to ZOOM.*/  
:MATH1:WAVetype? /*The query returns ZOOM.*/
```

3.16.14 :MATH<n>:FFT:SOURce**Syntax**

```
:MATH<n>:FFT:SOURce <source>
```

```
:MATH<n>:FFT:SOURce?
```

Description

Sets or queries the channel source of FFT operation.

Parameter

Name	Type	Range	Default
<n>	Discrete	{1 2 3 4}	-
<source>	Discrete	{CHANnel1 CHANnel2 CHANnel3 CHANnel4}	CHANnel1

Remarks

N/A

Return Format

The query returns CHAN1, CHAN2, CHAN3, or CHAN4.

Example

```
:MATH1:FFT:SOURce CHANnel3 /*Sets the channel source of FFT operation to CHANnel3.*/  
:MATH1:FFT:SOURce? /*The query returns CHAN3.*/
```

3.16.15 :MATH<n>:FFT:WINDow

Syntax

```
:MATH<n> :FFT:WINDow <window>
```

```
:MATH<n> :FFT:WINDow?
```

Description

Sets or queries the window function of FFT operation.

Parameter

Name	Type	Range	Default
<n>	Discrete	{1 2 3 4}	-
<window>	Discrete	{RECTangle BLACkman HANNing HAMMing FLATtop TRlangle}	HANNing

Remarks

- Spectral leakage can be considerably minimized when a window function is used.
- Different window functions are applicable to measurements of different waveforms. You need to select the window function according to the different waveforms to be measured and their characteristics. For the characteristics of the window function and its applicable waveforms, refer to [Table 3.161 Window Function](#).

Return Format

The query returns RECT, BLAC, HANN, HAMM, FLAT, or TRI.

Example

```
:MATH1:FFT:WINDow BLACkman /*Sets the window function of FFT
operation to Blackman-Harris.*/
:MATH1:FFT:WINDow? /*The query returns BLAC.*/
```

3.16.16 :MATH<n>:FFT:UNIT

Syntax

```
:MATH<n> :FFT:UNIT <unit>
```

```
:MATH<n> :FFT:UNIT?
```

Description

Sets or queries the vertical unit of FFT operation results.

Parameter

Name	Type	Range	Default
<n>	Discrete	{1 2 3 4}	-
<unit>	Discrete	{VRMS DB}	DB

Remarks

N/A

Return Format

The query returns VRMS or DB.

Example

```
:MATH1:FFT:UNIT VRMS /*Sets the vertical unit of FFT operation
results to Vrms.*/
:MATH1:FFT:UNIT? /*The query returns VRMS.*/
```

3.16.17 :MATH<n>:FFT:SCALE**Syntax**

```
:MATH<n>:FFT:SCALE <scale>
```

```
:MATH<n>:FFT:SCALE?
```

Description

Sets or queries the vertical unit of FFT operation results.

Parameter

Name	Type	Range	Default
<n>	Discrete	{1 2 3 4}	-
<scale>	Real	Refer to <i>Remarks</i>	-

Remarks

- When the unit is set to dB, the range of <scale> is from 1 ndB to 5 GdB. The default value is 20 dB.
- When the unit is set to V_{rms} , the range of <scale> is from 1 nV_{rms} to 5 GV_{rms}. The default value is 10 V_{rms}.

You can run the `:MATH<n>:FFT:UNIT` command to configure or query the current unit.

Return Format

The query returns the current vertical scale in scientific notation.

Example

```
:MATH1:FFT:SCALE 0.3 /*Sets the vertical scale of the FFT
operation results to 300 mdB.*/
:MATH1:FFT:SCALE? /*The query returns 3.000000E-1.*/
```

3.16.18 :MATH<n>:FFT:OFFSet

Syntax

```
:MATH<n>:FFT:OFFSet <offset>
```

```
:MATH<n>:FFT:OFFSet?
```

Description

Sets or queries the vertical offset of FFT operation results.

Parameter

Name	Type	Range	Default
<n>	Discrete	{1 2 3 4}	-
<offset>	Real	Refer to <i>Remarks</i>	0 dB

Remarks

- When the unit is set to dB, the range of <offset> is from -1 GdB to 1 GdB. The default value is 0 dB.
- When the unit is set to V_{rms} , the range of <offset> is from -1 GV_{rms} to 1 GV_{rms} . The default value is 0 V_{rms} .

You can run the `:MATH<n>:FFT:UNIT` command to configure or query the current unit.

Return Format

The query returns the current vertical offset in scientific notation.

Example

```
:MATH1:FFT:OFFSet 0.3 /*Sets the vertical offset of the FFT
operation results to 300 mdB.*/
:MATH1:FFT:OFFSet? /*The query returns 3.000000E-1.*/
```

3.16.19 :MATH<n>:FFT:HSCale

Syntax

```
:MATH<n>:FFT:HSCale <hsc>
```

```
:MATH<n>:FFT:HSCale?
```

Description

Sets or queries the frequency range of FFT operation results. The default unit is Hz.

Parameter

Name	Type	Range	Default
<n>	Discrete	{1 2 3 4}	-
<hsc>	Real	10 Hz to 1GHz	10 MHz

Remarks

You can reduce the frequency range to observe the details of the spectrum.

Modifying the frequency range of the FFT operation results will affect the value of the center frequency. You can run the `:MATH<n>:FFT:HCENter` command to query or modify the center frequency.

Return Format

The query returns the current frequency range in scientific notation.

Example

```
:MATH1:FFT:HSCale 500000 /*Sets the frequency range of the FFT
operation results to 500 kHz.*/
:MATH1:FFT:HSCale? /*The query returns 5.000000E+5.*/
```

3.16.20 :MATH<n>:FFT:HCENter

Syntax

```
:MATH<n>:FFT:HCENter <cent>
```

```
:MATH<n>:FFT:HCENter?
```

Description

Sets or queries the center frequency of FFT operation results, that is, the frequency relative to the horizontal center of the screen.

Parameter

Name	Type	Range	Default
<n>	Discrete	{1 2 3 4}	-

Name	Type	Range	Default
<cent>	Real	5 Hz to 1GHz	5 MHz

Remarks

Modifying the center frequency of the FFT operation results will affect the value of the frequency range. You can run the `:MATH<n>:FFT:HSCale` command to query or modify the frequency range.

Return Format

The query returns the current center frequency in scientific notation. The unit is Hz.

Example

```
:MATH1:FFT:HCEnter 10000000 /*Sets the center frequency of the
FFT operation results to 10 MHz.*/
:MATH1:FFT:HCEnter? /*The query returns 1.000000E+7.*/
```

3.16.21 :MATH<n>:FFT:FREQuency:START**Syntax**

```
:MATH<n>:FFT:FREQuency:START <value>
```

```
:MATH<n>:FFT:FREQuency:START?
```

Description

Sets or queries the start frequency of FFT operation results.

Parameter

Name	Type	Range	Default
<n>	Discrete	{1 2 3 4}	-
<value>	Real	0 Hz to (stop frequency -10 Hz)	0 Hz

Remarks

The range of the start frequency of FFT operation is related to the stop frequency. You can run the `:MATH<n>:FFT:FREQuency:END` command to query or configure the stop frequency.

Return Format

The query returns the start frequency of the operation results in scientific notation. The unit is Hz.

Example

```
:MATH1:FFT:FREQuency:START 10000000 /*Sets the start frequency of
the FFT operation results to 10 MHz.*/
```

```
:MATH1:FFT:FREQuency:START? /*The query returns 1.000000E
+7.*/
```

3.16.22 :MATH<n>:FFT:FREQuency:END

Syntax

```
:MATH<n>:FFT:FREQuency:END <value>
```

```
:MATH<n>:FFT:FREQuency:END?
```

Description

Sets or queries the stop frequency of FFT operation results.

Parameter

Name	Type	Range	Default
<n>	Discrete	{1 2 3 4}	-
<value>	Real	(Start Freq + 10 Hz) to 1 GHz	10 MHz

Remarks

The range of the stop frequency of FFT operation is related to the start frequency. You can run the `:MATH<n>:FFT:FREQuency:START` command to query or configure the start frequency.

Return Format

The query returns the stop frequency of the operation results in scientific notation. The unit is Hz.

Example

```
:MATH1:FFT:FREQuency:END 10000000 /*Sets the stop frequency of
the FFT operation results to 10 MHz.*/
:MATH1:FFT:FREQuency:END? /*The query returns 1.000000E
+7.*/
```

3.16.23 :MATH<n>:FFT:SEARCh:ENABLE

Syntax

```
:MATH<n>:FFT:SEARCh:ENABLE <bool>
```

```
:MATH<n>:FFT:SEARCh:ENABLE?
```

Description

Enables or disables the FFT peak search; or queries the on/off status of the FFT peak search function.

Parameter

Name	Type	Range	Default
<n>	Discrete	{1 2 3 4}	-
<bool>	Bool	{{1 ON}}{0 OFF}}	0 OFF

Remarks

N/A

Return Format

The query returns 1 or 0.

Example

```
:MATH1:FFT:SEARCh:ENABle ON          /*Enables the FFT peak search.*/
:MATH1:FFT:SEARCh:ENABle?           /*The query returns 1.*/
```

3.16.24 :MATH<n>:FFT:SEARCh:NUM**Syntax**

```
:MATH<n>:FFT:SEARCh:NUM <num>
```

```
:MATH<n>:FFT:SEARCh:NUM?
```

Description

Sets or queries the maximum number of the FFT peak search.

Parameter

Name	Type	Range	Default
<n>	Discrete	{1 2 3 4}	-
<num>	Integer	1 to 15	5

Remarks

N/A

Return Format

The query returns an integer ranging from 1 to 15.

Example

```
:MATH1:FFT:SEARCh:NUM 10           /*Sets the maximum number of the
FFT peak search to 10.*/
:MATH1:FFT:SEARCh:NUM?             /*The query returns 10.*/
```

3.16.25 :MATH<n>:FFT:SEARch:THReshold

Syntax

```
:MATH<n>:FFT:SEARch:THReshold <thres>
```

```
:MATH<n>:FFT:SEARch:THReshold?
```

Description

Sets or queries the threshold of the FFT peak search.

Parameter

Name	Type	Range	Default
<n>	Discrete	{1 2 3 4}	-
<thres>	Real	Related to the vertical scale and vertical offset of FFT operation	5.5 dB

Remarks

N/A

Return Format

The query returns the threshold in scientific notation.

Example

```
:MATH1:FFT:SEARch:THReshold 0.5 /*Sets the threshold of the
FFT peak search to 500 mdB.*/
:MATH1:FFT:SEARch:THReshold? /*The query returns
5.000000E-1.*/
```

3.16.26 :MATH<n>:FFT:SEARch:EXCursion

Syntax

```
:MATH<n>:FFT:SEARch:EXCursion <excur>
```

```
:MATH<n>:FFT:SEARch:EXCursion?
```

Description

Sets or queries the excursion of the FFT peak search.

Parameter

Name	Type	Range	Default
<n>	Discrete	{1 2 3 4}	-
<excur>	Real	0 to (8 x VerticalScale)	1.8 dB

Remarks

VerticalScale indicates the vertical scale of FFT.

Return Format

The query returns the excursion in scientific notation.

Example

```
:MATH1:FFT:SEARCh:EXCursion 0.5 /*Sets the excursion of the
FFT peak search to 500 mdB.*/
:MATH1:FFT:SEARCh:EXCursion? /*The query returns
5.000000E-1.*/
```

3.16.27 :MATH<n>:FFT:SEARCh:ORDER**Syntax**

```
:MATH<n>:FFT:SEARCh:ORDER <order>
```

```
:MATH<n>:FFT:SEARCh:ORDER?
```

Description

Sets or queries the sequence of the FFT peak search results.

Parameter

Name	Type	Range	Default
<n>	Discrete	{1 2 3 4}	-
<order>	Discrete	{AMPorder FREQorder}	AMPorder

Remarks

N/A

Return Format

The query returns AMP or FREQ.

Example

```
:MATH1:FFT:SEARCh:ORDER AMPorder /*Sets the sequence of the FFT
peak search results to AMPorder.*/
:MATH1:FFT:SEARCh:ORDER? /*The query returns AMP.*/
```

3.16.28 :MATH<n>:FFT:SEARCh:RES?**Syntax**

```
:MATH<n>:FFT:SEARCh:RES?
```

Description

Queries the peak search results table.

Parameter

Name	Type	Range	Default
<n>	Discrete	{1 2 3 4}	-

Remarks

N/A

Return Format

The query returns the peak search results table in strings.

Example

```
:MATH1:FFT:SEARCH:RES? /*The query returns the peak search
results table in strings.*/
1,2.50000MHz,-24.98dBV
2,3.50000MHz,-27.84dBV
3,4.50000MHz,-30.04dBV
4,5.50125MHz,-31.5dBV
5,6.50125MHz,-32.34dBV
```

3.16.29 :MATH<n>:FILTER:TYPE**Syntax**

```
:MATH<n>:FILTER:TYPE <type>
```

```
:MATH<n>:FILTER:TYPE?
```

Description

Sets or queries the filter type.

Parameter

Name	Type	Range	Default
<n>	Discrete	{1 2 3 4}	-
<type>	Discrete	{LPASs HPASs BPASs BStop}	LPASs

Remarks

The oscilloscope provides 4 practical filters (Low Pass Filter, High Pass Filter, Band Pass Filter, and Band Stop Filter), which can filter the specified frequencies in the signal by setting the bandwidth. You can use the `:MATH<n>:FFT:SOURce` command to set or query the channel source of the filter.

- **LPASs:** indicates low pass filter, which only allows the signals whose frequencies are smaller than the current cut-off frequency to pass.
- **HPASs:** indicates high pass filter, which only allows the signals whose frequencies are greater than the current cut-off frequency to pass.
- **BPASs:** indicates band pass filter, which only allows the signals whose frequencies are greater than the current cut-off frequency 1 and smaller than the current cut-off frequency 2 to pass.

Note: The cut-off frequency 1 must be smaller than the cut-off frequency 2.

- **BSTop:** indicates band stop filter, which only allows the signals whose frequencies are smaller than the current cut-off frequency 1 or greater than the current cut-off frequency 2 to pass.

Note: The cut-off frequency 1 must be smaller than the cut-off frequency 2.

Return Format

The query returns LPAS, HPAS, BPAS, or BST.

Example

```
:MATH1:FILTer:TYPE LPASs /*Sets the filter type to Low Pass
Filter.*/
:MATH1:FILTer:TYPE? /*The query returns LPAS.*/
```

3.16.30 :MATH<n>:FILTer:W1

Syntax

```
:MATH<n>:FILTer:W1 <freq1>
```

```
:MATH<n>:FILTer:W1?
```

Description

Sets or queries the cut-off frequency of Low Pass Filter/High Pass Filter; or the cut-off frequency 1 of Band Pass Filter/Band Stop Filter. The default unit is Hz.

Parameter

Name	Type	Range	Default
<n>	Discrete	{1 2 3 4}	-
<freq1>	Real	Refer to <i>Remarks</i>	Refer to <i>Remarks</i>

Remarks

- When the filter type is set to LPASs (Low Pass Filter) or HPASs (High Pass Filter), you need to set one cut-off frequency. At this time, the range of <freq1> is from (0.005 x screen sample rate) to (0.1 x screen sample rate), at a step of (0.005 x screen sample rate); wherein, screen sample rate = 100/horizontal time base.
- When the filter type is set to BPASs (Band Pass Filter) or BStop (Band Stop Filter), you need to set two cut-off frequencies. Note: The cut-off frequency 1 must be smaller than the cut-off frequency 2. Run this command to set the cut-off frequency 1, and run the `:MATH<n>:FILTer:W2` command to set the cut-off frequency 2. At this time, the range of <freq1> is from (0.005 x screen sample rate) to (0.095 x screen sample rate), at a step of (0.005 x screen sample rate); wherein, screen sample rate = 100/horizontal time base.
- The default value of <freq1> is related to the filter type.
 - When the filter type is set to LPASs (Low Pass Filter), BPASs (Band Pass Filter), or BStop (Band Stop Filter), the default value is 0.005 x screen sample rate.
 - When the filter type is set to HPASs (High Pass Filter), the default value is 0.1 x screen sample rate.
- You can use `:MATH<n>:FILTer:TYPE` to set or query the filter type.

Return Format

The query returns the current cut-off frequency or cut-off frequency 1 in scientific notation.

Example

```
:MATH1:FILTer:W1 1000000 /*Sets the cut-off frequency of Low
Pass Filter to 1 MHz.*/
:MATH1:FILTer:W1? /*The query returns 1.000000E+6.*/
```

3.16.31 :MATH<n>:FILTer:W2**Syntax**

```
:MATH<n>:FILTer:W2 <freq2>
```

```
:MATH<n>:FILTer:W2?
```

Description

Sets or queries the cut-off frequency 2 of Band Pass Filter/Band Stop Filter. The default unit is Hz.

Parameter

Name	Type	Range	Default
<n>	Discrete	{1 2 3 4}	-
<freq2>	Real	Refer to <i>Remarks</i>	0.1 x screen sample rate

Remarks

When the filter type is set to BPASs (Band Pass Filter) or BStop (Band Stop Filter), you need to set two cut-off frequencies. Note: The cut-off frequency 2 must be smaller than the cut-off frequency 1. Run the `:MATH<n>:FILTer:W1` command to set the cut-off frequency 1, and run this command to set the cut-off frequency 2. At this time, the range of <freq2> is from (0.01 x screen sample rate) to (0.1 x screen sample rate), at a step of (0.005 x screen sample rate); wherein, screen sample rate = 100/horizontal time base.

Return Format

The query returns the current cut-off frequency 2 in scientific notation.

Example

```
:MATH1:FILTer:W2 1500000 /*Sets the cut-off frequency 2 of
Band Pass Filter to 1.5 Mhz.*/
:MATH1:FILTer:W2? /*The query returns 1.500000E+6.*/
```

3.16.32 :MATH<n>:SENSitivity

Syntax

```
:MATH<n>:SENSitivity <sens>
```

```
:MATH<n>:SENSitivity?
```

Description

Sets or queries the sensitivity of the logic operation. The default unit is div.

Parameter

Name	Type	Range	Default
<n>	Discrete	{1 2 3 4}	-
<sens>	Real	100 mdiv to 1 div	300 mdiv

Remarks

N/A

Return Format

The query returns the sensitivity of the logic operation in scientific notation.

Example

```
:MATH1:SENSitivity 0.2 /*Sets the sensitivity of the logic
operation to 0.2 div.*/
:MATH1:SENSitivity? /*The query returns 2.000000E-1.*/
```

3.16.33 :MATH<n>:DISTance**Syntax**

:MATH<n>:DISTance <dist>

:MATH<n>:DISTance?

Description

Sets or queries the smoothing window width of differential operation.

Parameter

Name	Type	Range	Default
<n>	Discrete	{1 2 3 4}	-
<dist>	Integer	1 to 1,000	-

Remarks

N/A

Return Format

The query returns an integer ranging from 1 to 1,000.

Example

```
:MATH1:DISTance 20 /*Sets the smoothing window width of
differential operation to 20.*/
:MATH1:DISTance? /*The query returns 20.*/
```

3.16.34 :MATH<n>:THReshold1**Syntax**

:MATH<n>:THReshold1 <thre>

:MATH<n>:THReshold1?

Description

Sets or queries threshold level of Analog Channel 1 in the logic operation. The default unit is V.

Parameter

Name	Type	Range	Default
<n>	Discrete	{1 2 3 4}	-
<thre>	Real	(-4 × VerticalScale - VerticalOffset) to (4 × VerticalScale - VerticalOffset)	0 V

Remarks

- This command is only available for the logic operations A&&B, A||B, A^B, and !A.
- VerticalScale indicates the vertical scale of Analog Channel 1. VerticalOffset indicates the vertical offset of Analog Channel 1. The step value is VerticalScale/10.

Return Format

The query returns the threshold level of of Analog Channel 1 in scientific notation.

Example

```
:MATH1:THReshold1 0.8 /*Sets the threshold level of Analog
Channel 1 in logic operation to 800 mV.*/
:MATH1:THReshold1? /*The query returns 8.000000E-1.*/
```

3.16.35 :MATH<n>:THReshold2**Syntax**

```
:MATH<n>:THReshold2 <thre>
```

```
:MATH<n>:THReshold2?
```

Description

Sets or queries threshold level of Analog Channel 2 in the logic operation. The default unit is V.

Parameter

Name	Type	Range	Default
<n>	Discrete	{1 2 3 4}	-
<thre>	Real	(-4 × VerticalScale - VerticalOffset) to (4 × VerticalScale - VerticalOffset)	0 V

Remarks

- This command is only available for the logic operations A&&B, A||B, A^B, and !A.
- VerticalScale indicates the vertical scale of Analog Channel 2. VerticalOffset indicates the vertical offset of Analog Channel 2. The step value is VerticalScale/10.

Return Format

The query returns the threshold level of of Analog Channel 2 in scientific notation.

Example

```
:MATH1:THReshold2 0.8 /*Sets the threshold level of Analog
Channel 2 in logic operation to 800 mV.*/
:MATH1:THReshold2? /*The query returns 8.000000E-1.*/
```

3.16.36 :MATH<n>:THReshold3**Syntax**

```
:MATH<n>:THReshold3 <thre>
```

```
:MATH<n>:THReshold3?
```

Description

Sets or queries threshold level of Analog Channel 3 in the logic operation. The default unit is V.

Parameter

Name	Type	Range	Default
<n>	Discrete	{1 2 3 4}	-
<thre>	Real	(-4 × VerticalScale - VerticalOffset)	0 V

Name	Type	Range	Default
		to (4 × VerticalScale - VerticalOffset)	

Remarks

- This command is only available for the logic operations A&&B, A||B, A^B, and !A.
- VerticalScale indicates the vertical scale of Analog Channel 3. VerticalOffset indicates the vertical offset of Analog Channel 3. The step value is VerticalScale/10.

Return Format

The query returns the threshold level of of Analog Channel 3 in scientific notation.

Example

```
:MATH1:THReshold3 0.8 /*Sets the threshold level of Analog
Channel 3 in logic operation to 800 mV.*/
:MATH1:THReshold3? /*The query returns 8.000000E-1.*/
```

3.16.37 :MATH<n>:THReshold4**Syntax**

```
:MATH<n>:THReshold4 <thre>
```

```
:MATH<n>:THReshold4?
```

Description

Sets or queries threshold level of Analog Channel 4 in the logic operation. The default unit is V.

Parameter

Name	Type	Range	Default
<n>	Discrete	{1 2 3 4}	-
<thre>	Real	(-4 × VerticalScale - VerticalOffset) to (4 × VerticalScale - VerticalOffset)	0 V

Remarks

- This command is only available for the logic operations $A \& B$, $A || B$, $A \wedge B$, and $!A$.
- VerticalScale indicates the vertical scale of Analog Channel 4. VerticalOffset indicates the vertical offset of Analog Channel 4. The step value is VerticalScale/10.

Return Format

The query returns the threshold level of of Analog Channel 4 in scientific notation.

Example

```
:MATH1:THReshold4 0.8 /*Sets the threshold level of Analog
Channel 4 in logic operation to 800 mV.*/
:MATH1:THReshold4? /*The query returns 8.000000E-1.*/
```

3.16.38 :MATH<n>:WINDow:TITLe?**Syntax**

```
:MATH<n>:WINDow:TITLe?
```

Description

Queries the title of the specified math operation window.

Parameter

Name	Type	Range	Default
<n>	Discrete	{1 2 3 4}	-

Remarks

N/A

Return Format

The query returns the title of the specified math operation window in strings.

Example

```
:MATH1:WINDow:TITLe? /*The query returns Math1 CH1*CH1 Scale:0U
Sa:2GSa/s.*/
```

3.16.39 :MATH<n>:LABel:SHOW**Syntax**

```
:MATH<n>:LABel:SHOW <bool>
```

```
:MATH<n>:LABel:SHOW?
```

Description

Sets or queries whether to display the waveform label of the specified operation.

Parameter

Name	Type	Range	Default
<n>	Discrete	{1 2 3 4}	-
<bool>	Bool	{{1 ON}} {0 OFF}}	-

Remarks

N/A

Return Format

The query returns 1 or 0.

Example

```
:MATH1:LABel:ENABle ON /*Enables the display of the
label.*/
:MATH1:LABel:ENABle? /*The query returns 1.*/
```

3.17 :MEASure Commands

:MEASure commands are used to set and query the parameters related to measurements.

This oscilloscope allows you to set the measurement source, enable or disable the all measurement function, the statistical function, and etc.

Measurement Parameters

TIP

If there is no signal input for the current source or the measurement result is not within the valid range (too large or too small), then the measurement results are invalid.

Horizontal Parameters

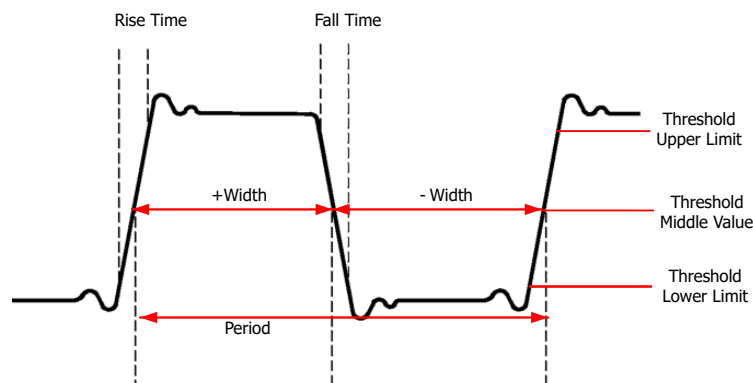

- **Period (PERiod):** defined as the time between the middle threshold points of two consecutive, like-polarity edges.
- **Frequency (FREquency):** defined as the reciprocal of period.
- **Rise Time (RTIME):** indicates the time for the signal amplitude to rise from the threshold lower limit to the threshold upper limit.
- **Fall Time (FTIME):** indicates the time for the signal amplitude to drop from the threshold upper limit to the threshold lower limit.
- **+Width (PWIDth):** indicates the time between the threshold middle value of a rising edge to the threshold middle value of the next falling edge.
- **-Width (NWIDth):** indicates the time between the threshold middle value of a falling edge to the threshold middle value of the next rising edge.
- **+Duty (PDUTy):** indicates the ratio of the positive pulse width to the period.
- **-Duty (NDUTy):** indicates the ratio of the negative pulse width to the period.
- **Tvmax (TVMAX):** indicates the time that corresponds to the maximum value of the waveform (V_{max}).
- **Tvmin (TVMIN):** indicates the time that corresponds to the minimum value of the waveform (V_{min}).

Delay and Phase Parameters

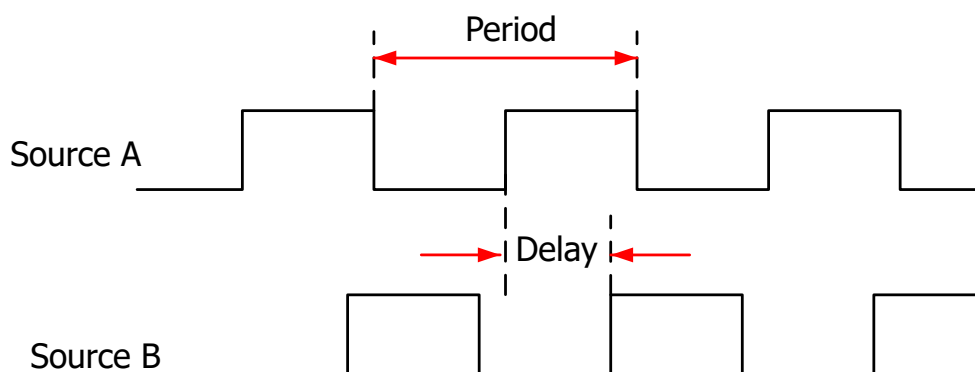

- **Delay(r-r) (RRDelay):** indicates the time difference between the threshold middle values of the rising edge of Source A and that of Source B. Negative delay indicates that the rising edge of Source A occurred after that of Source B.

- **Delay(f-f) (FFDelay):** indicates the time difference between the threshold middle values of the falling edge of Source A and that of Source B. Negative delay indicates that the falling edge of Source A occurred after that of Source B.
- **Delay(r-f) (RFDelay):** indicates the time difference between the threshold middle values of the rising edge of Source A and the falling edge of Source B. Negative delay indicates that the rising edge of Source A occurred after the falling edge of Source B.
- **Delay(f-r) (FRDelay):** indicates the time difference between the threshold middle values of the rising edge of Source A and that of Source B. Negative delay indicates that the falling edge of Source A occurred after the rising edge of Source B.
- **Phase(r-r) (RRPhase):** indicates the phase deviation between the threshold middle values of the rising edge of Source A and that of Source B.
- **Phase(f-f) (FFPhase):** indicates the phase deviation between the threshold middle values of the falling edge of Source A and that of Source B.
- **Phase(r-f) (RFPPhase):** indicates the phase deviation between the threshold middle values of the rising edge of Source A and the falling edge of Source B.
- **Phase(f-r) (FRPhase):** indicates the phase deviation between the threshold middle values of the rising edge of Source A and that of Source B.

Count Values

- **Positive Pulse Count (PPULses):** It is specified as the number of positive pulses that rise from under the threshold lower limit to above the threshold upper limit.

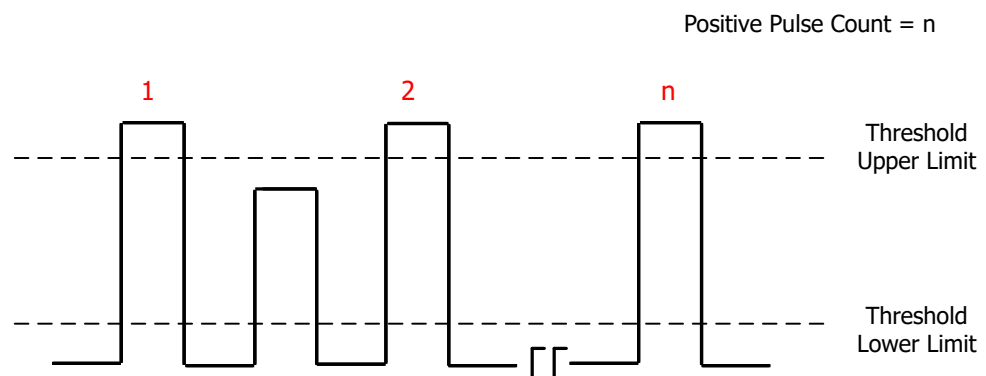

- Negative Pulse Count (NPULses):** It is specified as the number of negative pulses that fall from above the threshold upper limit to below the threshold lower limit.

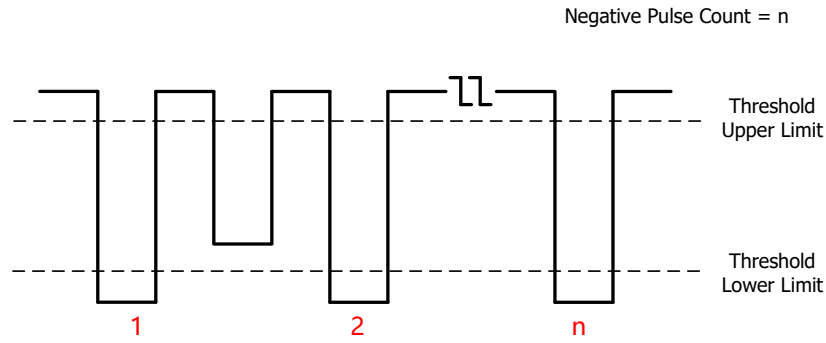

- Rising Edge Count (PEDGes):** It is specified as the number of rising edges that rise from under the threshold lower limit to above the threshold upper limit.

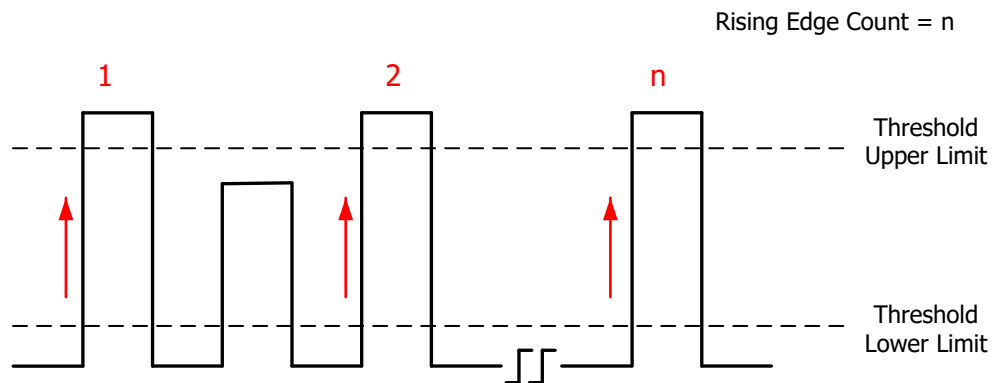

- Falling Edge Count (NEDGes):** It is specified as the number of falling edges that fall from above the threshold upper limit to below the threshold lower limit.

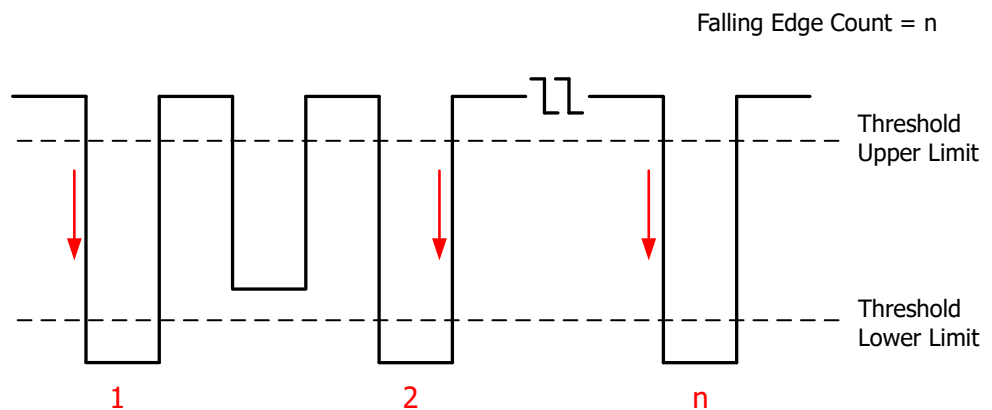

Voltage Parameters

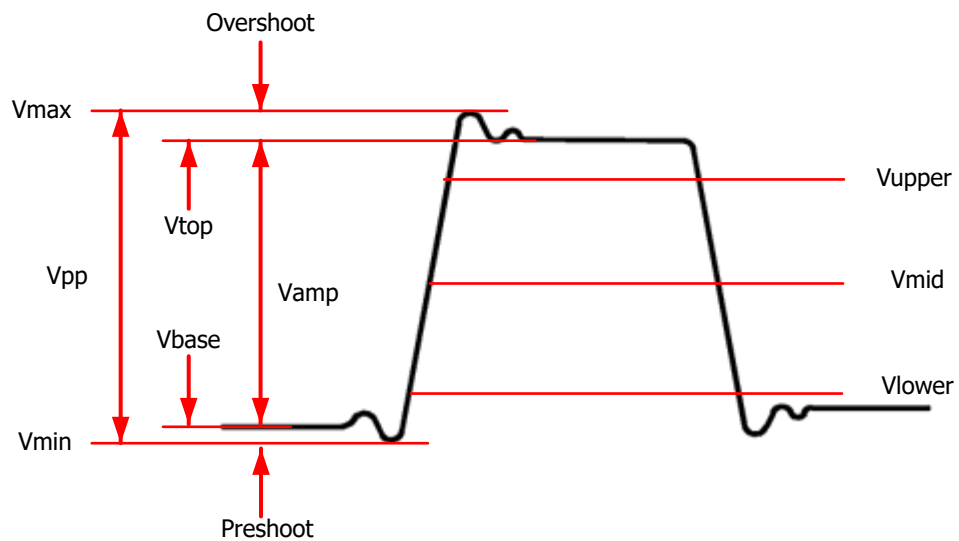

- **Vmax (VMAX):** indicates the voltage value from the highest point of the waveform to the GND.
- **Vmin (VMIN):** indicates the voltage value from the lowest point of the waveform to the GND.
- **Vpp (VPP):** indicates the voltage value from the highest point to the lowest point of the waveform.
- **Vtop (VTOP):** indicates the voltage value from the flat top of the waveform to the GND.
- **Vbase (VBASe):** indicates the voltage value from the flat base of the waveform to the GND.
- **Vamp (VAMP):** indicates the voltage value from the top of the waveform to the base of the waveform.
- **Vupper (VUPPer):** indicates the actual voltage value that corresponds to the threshold maximum value.
- **Vmid (VMID)** indicates the actual voltage value that corresponds to the threshold middle value.
- **Vlower (VLOWer):** indicates the actual voltage value that corresponds to the threshold minimum value.

- **Vavg (VAVG):** indicates the arithmetic average value on the whole waveform or in the gating area.
- **VRMS (VRMS):** indicates the root mean square value on the whole waveform or in the gating area.
- **Per.VRMS (PVRMs):** indicates the root mean square value within a period.
- **Overshoot (OVERshoot):** indicates the ratio of the difference between the maximum value and the top value of the waveform to the amplitude value.
- **Preshoot (PREShoot):** indicates the ratio of the difference between the minimum value and the base value of the waveform to the amplitude value.
- **AC RMS (ACRMs):** indicates the root-mean-square value of the waveforms, with the DC component removed.

Other Parameters

- **Positive Slew Rate (PSLewrate):** On the rising edge, first calculate the difference between the high value and the low value, then use the difference to divide the corresponding time value to obtain the positive slew rate.
- **Negative Slew Rate (NSLewrate):** On the falling edge, first calculate the difference between the low value and the high value, then use the difference to divide the corresponding time value to obtain the negative slew rate.
- **Area (MAREa):** indicates the area of the whole waveform within the screen. The unit is V*s. The area of the waveform above the zero reference (namely the vertical offset) is positive, and the area of the waveform below the zero reference is negative. The area measured is the algebraic sum of the area of the whole waveform within the screen.
- **Period Area (MPAREa):** indicates the area of the first period of waveform on the screen. The unit is V*s. The area of the waveform above the zero reference (namely the vertical offset) is positive, and the area of the waveform below the zero reference is negative. The area measured is the algebraic sum of the whole period area.

Measurement Results

This oscilloscope can make a statistics and display the measurement results.

- **MAXimum:** the maximum value.
- **MINimum:** the minimum value.
- **CURRent:** the current value.
- **AVERages:** the average value.
- **DEVIation:** the standard deviation.
- **CNT:** the count value.

3.17.1 :MEASure:SOURce

Syntax

```
:MEASure:SOURce <source>
```

```
:MEASure:SOURce?
```

Description

Sets or queries the channel source of the current measurement parameter.

Parameter

Name	Type	Range	Default
<source>	Discrete	{D0 D1 D2 D3 D4 D5 D6 D7 D8 D9 D10 D11 D12 D13 D14 D15 CHANnel1 CHANnel2 CHANnel3 CHANnel4 MATH1 MATH2 MATH3 MATH4}	CHANnel1

Remarks

This command has the same function as the *:MEASure:SETup:DSA* and *:MEASure:SETup:PSA* commands.

D0-D15 are only available for the DHO900 series.

Return Format

The query returns D0, D1, D2, D3, D4, D5, D6, D7, D8, D9, D10, D11, D12, D13, D14, D15, CHAN1, CHAN2, CHAN3, CHAN4, MATH1, MATH2, MATH3, or MATH4.

Example

```
:MEASure:SOURce CHANnel2 /*Sets the channel source of the
measurement parameter to CHANnel2.*/
:MEASure:SOURce? /*The query returns CHAN2.*/
```

3.17.2 :MEASure:ITEM

Syntax

```
:MEASure:ITEM <item>[, <src>[, <src>]]
```

```
:MEASure:ITEM? <item>[, <src>[, <src>]]
```

Description

Measures any waveform parameter of the specified source, or queries the statistical results of any waveform parameter of the specified source.

Parameter

Name	Type	Range	Default
<item>	Discrete	{VMAX VMIN VPP VTOP VBASE VAMP VAVG VRMS OVERshoot PREShoot MARea MPARea PERiod FREQuency RTIME FTIME PWIDth NWIDth PDUTy NDUTy TVMAX TVMIN PSLewrate NSLewrate VUPPer VMID VLOWer VARiance PVRMs PPULses NPULses PEDGes NEDGes RRDelay RFDelay FRDelay FFDelay RRPHase RFPHase FRPHase FFPHase ACRMs}	-
<src>	Discrete	{D0 D1 D2 D3 D4 D5 D6 D7 D8 D9 D10 D11 D12 D13 D14 D15 CHANnel1 CHANnel2 CHANnel3 CHANnel4 MATH1 MATH2 MATH3 MATH4}	-

Remarks

- For the detailed measurement item parameter <item>, refer to [Measurement Parameters](#).
- The parameter [, <src>[, <src>]] is used to set the source of the parameter under measurement.
 - Digital channels (D0 to D15) are only supported by the DHO900 series.
 - If the parameter <item> is set to PERiod, FREQuency, PWIDth, NWIDth, PDUTy, NDUTy, RRDelay, RFDelay, FRDelay, FFDelay, RRPPhase, RFPPhase,

FRPHase, or FFPHase, the range of the parameter <src> can be any one of the values in {D0|D1|D2|D3|D4|D5|D6|D7|D8|D9|D10|D11|D12|D13|D14|D15|CHANnel1|CHANnel2|CHANnel3|CHANnel4|MATH1|MATH2|MATH3|MATH4}.

Otherwise, the range of <src> can be any one of the values in {CHANnel1|CHANnel2|CHANnel3|CHANnel4|MATH1|MATH2|MATH3|MATH4}.

- If the measurement parameter is a single source, you only need to set one source. If this parameter is omitted, then the source is, by default, the one that you've selected in the last sent command
(*:MEASure:SOURce*, *:MEASure:SETup:PSA*, or *:MEASure:SETup:DSA*).
- If the measurement parameter is a dual channel source, observe the following rules to determine the source that you've selected. That is, if the parameter <src> is omitted, the first source is, by default, the one that you've selected in the last sent command
(*:MEASure:SOURce*, *:MEASure:SETup:PSA*, or *:MEASure:SETup:DSA*); the second source is, by default, the one that you've selected in the last sent command (*:MEASure:SETup:PSB* or *:MEASure:SETup:DSB*).

Return Format

The query returns the current measurement value in scientific notation.

Example

```
:MEASure:ITEM OVERshoot,CHANnel2 /*Measures the overshoot value of
Channel 2.*/
:MEASure:ITEM? OVERshoot,CHANnel2 /*The query returns
8.888889E-3.*/
```

3.17.3 :MEASure:CLEAr

Syntax

:MEASure:CLEAr

Description

Clears all the enabled measurement items.

Parameter

N/A

Remarks

N/A

Return Format

N/A

Example

N/A

3.17.4 :MEASure:AMSource

Syntax`:MEASure:AMSource <chan>``:MEASure:AMSource?`**Description**

Sets the source and displays all measurement values of the set source; or queries the channel source(s) of the all measurement function.

Parameter

Name	Type	Range	Default
<chan>	Discrete	{CHANnel1 CHANnel2 CHANnel3 CHANnel4 OFF}	OFF

Remarks

N/A

Return Format

The query returns CHAN1, CHAN2, CHAN3, CHAN4, or OFF.

Example

```
:MEASure:AMSource CHANnel1 /*Sets the source to CHANnel1.*/
:MEASure:AMSource? /*The query returns CHAN1.*/
```

3.17.5 :MEASure:STATistic:COUNT

Syntax`:MEASure:STATistic:COUNT <val>``:MEASure:STATistic:COUNT?`**Description**

Sets or queries the statistics count.

Parameter

Name	Type	Range	Default
<val>	Integer	2 to 100,000	1,000

Remarks

N/A

Return Format

The query returns an integer ranging from 2 to 100,000.

Example

```
:MEASure:STATistic:COUNT 1000 /*Sets the statistics count to
1,000.*/
:MEASure:STATistic:COUNT? /*The query returns 1000.*/
```

3.17.6 :MEASure:STATistic:DISPlay**Syntax**

```
:MEASure:STATistic:DISPlay <bool>
```

```
:MEASure:STATistic:DISPlay?
```

Description

Enables or disables the statistical function; or queries the status of the statistical function.

Parameter

Name	Type	Range	Default
<bool>	Bool	{{1 ON}} {{0 OFF}}	0 OFF

Remarks

When the statistical function is enabled, the instrument makes statistics of the measurement results for at most 10 measurement items that are turned on last time and displays the statistical results.

Return Format

The query returns 1 or 0.

Example

```
:MEASure:STATistic:DISPlay ON /*Enables the statistical
function.*/
:MEASure:STATistic:DISPlay? /*The query returns 1.*/
```

3.17.7 :MEASure:STATistic:RESet

Syntax

```
:MEASure:STATistic:RESet
```

Description

Clears the history statistics data and makes statistics again.

Parameter

N/A

Remarks

N/A

Return Format

N/A

Example

N/A

3.17.8 :MEASure:STATistic:ITEM

Syntax

```
:MEASure:STATistic:ITEM <item> [, <src> [, <src> ]]
```

```
:MEASure:STATistic:ITEM? <type> , <item> [, <src> [, <src> ]]
```

Description

Enables the statistical function of any waveform parameter of the specified source, or queries the statistical results of any waveform parameter of the specified source.

Parameter

Name	Type	Range	Default
<item>	Discrete	{VMAX VMIN VPP VTOP VBASe VAMP VAVG VRMS OVERshoot PREShoot MARea MPARea PERiod FREQuency RTIME FTIME PWIDTH NWIDTh PDUTy NDUTy TVMAX TVMIN PSLewrate NSLewrate VUPPer VMID VLOWer VARiance PVRMs PPULses NPULses PEDGes NEDGes RRDelay RFDelay}	-

Name	Type	Range	Default
		FRDelay FFDelay RRPHase RFPHase FRPHase FFPHase ACRMs}	
<src>	Discrete	{D0 D1 D2 D3 D4 D5 D6 D7 D8 D9 D10 D11 D12 D13 D14 D15 CHANnel1 CHANnel2 CHANnel3 CHANnel4 MATH1 MATH2 MATH3 MATH4}	-
<type>	Discrete	{MAXimum MINimum CURRent AVERages DEVIation CNT}	-

Remarks

- For the detailed measurement item parameter <item>, refer to *Measurement Parameters*.
- The parameter [,<src>[,<src>]] is used to set the source of the parameter under measurement.
 - Digital channels (D0 to D15) are only supported by the DHO900 series.
 - If the parameter <item> is set to PERiod, FREQuency, PWIDth, NWIDth, PDUTy, NDUTy, RRDelay, RFDelay, FRDelay, FFDelay, RRPHase, RFPHase, FRPHase, or FFPHase, the range of the parameter <src> can be any one of the values in {D0|D1|D2|D3|D4|D5|D6|D7|D8|D9|D10|D11|D12|D13|D14|D15|CHANnel1|CHANnel2|CHANnel3|CHANnel4|MATH1|MATH2|MATH3|MATH4}.
Otherwise, the range of <src> can be any one of the values in {CHANnel1|CHANnel2|CHANnel3|CHANnel4|MATH1|MATH2|MATH3|MATH4}.
 - If the measurement parameter is a single source, you only need to set one source. If this parameter is omitted, then the source is, by default, the one that you've selected in the last sent command
(*:MEASure:SOURce*, *:MEASure:SETup:PSA*, or *:MEASure:SETup:DSA*).
 - If the measurement parameter is a dual channel source, observe the following rules to determine the source that you've selected. That is, if the parameter <src> is omitted, the first source is, by default, the one that you've selected in the last sent command

(*:MEASure:SOURce*, *:MEASure:SETup:PSA*, or *:MEASure:SETup:DSA*); the second source is, by default, the one that you've selected in the last sent command (*:MEASure:SETup:PSB* or *:MEASure:SETup:DSB*).

- For the results of <type>, refer to *Measurement Results*.

Return Format

The query returns the statistical results in scientific notation.

Example

```
:MEASure:STATistic:ITEM VPP,CHANnel2 /*Enables the statistical
function of the peak-peak value of CH2.*/
:MEASure:STATistic:ITEM? MAXimum,VPP /*Queries the maximum value.
The query returns 9.120000E-1.*/
```

3.17.9 :MEASure:SETup:MAX

Syntax

:MEASure:SETup:MAX <value>

:MEASure:SETup:MAX?

Description

Sets or queries the threshold level upper limit of the analog channel in auto measurement.

Parameter

Name	Type	Range	Default
<value>	Integer	Refer to <i>Remarks</i>	-

Remarks

The range of the upper limit of the threshold level is related to the current threshold level middle value. You can run the *:MEASure:SETup:MID* command to set or query the middle value of the threshold level of the analog channel in auto measurement.

- When the threshold type is percentage, its range is from (threshold middle value + 1%) to 100%.
- When the threshold type is absolute, its range changes with the probe ratio. Its max. range is from -100 MV to 100 MV; and its min. range is from -20 V to 20 V.

- When the set upper limit is smaller than the current threshold middle value, a message "Set at lower limit" will be displayed, and the threshold middle value will not be modified automatically.

Return Format

The query returns an integer. When the threshold type is absolute, the default unit of the returned value is V.

Example

```
:MEASure:SETup:MAX 95 /*Sets the upper limit of the threshold
level to 95%.*/
:MEASure:SETup:MAX? /*The query returns 95.*/
```

3.17.10 :MEASure:SETup:MID

Syntax

```
:MEASure:SETup:MID <value>
:MEASure:SETup:MID?
```

Description

Sets or queries the threshold level middle value of the analog channel in auto measurement.

Parameter

Name	Type	Range	Default
<value>	Integer	Refer to <i>Remarks</i>	-

Remarks

The set middle value must be smaller than the currently set upper limit and greater than the currently set lower limit.

You can send the *:MEASure:SETup:MAX* and *:MEASure:SETup:MIN* commands to set or query the threshold level upper limit and lower limit of the current analog channel in auto measurement.

Return Format

The query returns an integer. When the threshold type is absolute, the default unit of the returned value is V.

Example

```
:MEASure:SETup:MID 89 /*Sets the middle value of the threshold
level to 89%.*/
:MEASure:SETup:MID? /*The query returns 89.*/
```

3.17.11 :MEASure:SETup:MIN

Syntax

```
:MEASure:SETup:MIN <value>
```

```
:MEASure:SETup:MIN?
```

Description

Sets or queries the threshold level lower limit of the analog channel in auto measurement.

Parameter

Name	Type	Range	Default
<value>	Integer	Refer to <i>Remarks</i>	-

Remarks

The range of the threshold level lower limit is related to the current threshold middle value. You can send the `:MEASure:SETup:MID` command to set or query the threshold middle value of the current analog channel in auto measurement.

- When the threshold type is percentage, its range is from 0% to (threshold middle value - 1%).
- When the threshold type is absolute, its range changes with the probe ratio. Its max. range is from -100 MV to 100 MV; and its min. range is from -20 V to 20 V.
- When the set lower limit is greater than the current threshold middle value, a message "Set at upper limit" will be displayed, and the threshold middle value will not be modified automatically.

Return Format

The query returns an integer. When the threshold type is absolute, the default unit of the returned value is V.

Example

```
:MEASure:SETup:MIN 53 /*Sets the lower limit of the threshold
level to 53%.*/
:MEASure:SETup:MIN? /*The query returns 53.*/
```

3.17.12 :MEASure:SETup:PSA

Syntax

```
:MEASure:SETup:PSA <source>
```

:MEASure:SETup:PSA?

Description

Sets or queries Source A in the phase or delay measurement.

Parameter

Name	Type	Range	Default
<source>	Discrete	{D0 D1 D2 D3 D4 D5 D6 D7 D8 D9 D10 D11 D12 D13 D14 D15 CHANnel1 CHANnel2 CHANnel3 CHANnel4 MATH1 MATH2 MATH3 MATH4}	CHANnel1

Remarks

This command has the same function as the *:MEASure:SOURce* and *:MEASure:SETup:DSA* commands.

D0-D15 are only available for the DHO900 series.

Return Format

The query returns D0, D1, D2, D3, D4, D5, D6, D7, D8, D9, D10, D11, D12, D13, D14, D15, CHAN1, CHAN2, CHAN3, CHAN4, MATH1, MATH2, MATH3, or MATH4.

Example

```
:MEASure:SETup:PSA CHANnel1 /*Sets Source A of the phase
measurement to CHANnel1.*/
:MEASure:SETup:PSA? /*The query returns CHAN1.*/
```

3.17.13 :MEASure:SETup:PSB

Syntax

:MEASure:SETup:PSB <source>

:MEASure:SETup:PSB?

Description

Sets or queries Source B in the phase or delay measurement.

Parameter

Name	Type	Range	Default
<source>	Discrete	{D0 D1 D2 D3 D4 D5 D6 D7 D8 D9 D10 D11 D12 D13 D14 D15 CHANnel1 CHANnel2 CHANnel3 CHANnel4 MATH1 MATH2 MATH3 MATH4}	CHANnel1

Remarks

This command has the same function as the `:MEASure:SETup:DSB` command.
D0-D15 are only available for the DHO900 series.

Return Format

The query returns D0, D1, D2, D3, D4, D5, D6, D7, D8, D9, D10, D11, D12, D13, D14, D15, CHAN1, CHAN2, CHAN3, CHAN4, MATH1, MATH2, MATH3, or MATH4.

Example

```
:MEASure:SETup:PSB CHANnel2 /*Sets Source B of the phase
measurement to CHANnel2.*/
:MEASure:SETup:PSB? /*The query returns CHAN2.*/
```

3.17.14 :MEASure:SETup:DSA

Syntax

```
:MEASure:SETup:DSA <source>
:MEASure:SETup:DSA?
```

Description

Sets or queries Source A in the phase or delay measurement.

Parameter

Name	Type	Range	Default
<source>	Discrete	{D0 D1 D2 D3 D4 D5 D6 D7 D8 D9 D10 D11 D12 D13 D14 D15 CHANnel1 CHANnel2 CHANnel3 CHANnel4 MATH1 MATH2 MATH3 MATH4}	CHANnel1

Remarks

This command has the same function as the `:MEASure:SOURce` and `:MEASure:SETup:PSA` commands.

D0-D15 are only available for the DHO900 series.

Return Format

The query returns D0, D1, D2, D3, D4, D5, D6, D7, D8, D9, D10, D11, D12, D13, D14, D15, CHAN1, CHAN2, CHAN3, CHAN4, MATH1, MATH2, MATH3, or MATH4.

Example

```
:MEASure:SETup:DSA CHANnel1 /*Sets Source A of the delay
measurement to CHANnel1.*/
:MEASure:SETup:DSA? /*The query returns CHAN1.*/
```

3.17.15 :MEASure:SETup:DSB

Syntax

```
:MEASure:SETup:DSB <source>
```

```
:MEASure:SETup:DSB
```

Description

Sets or queries Source B in the phase or delay measurement.

Parameter

Name	Type	Range	Default
<source>	Discrete	{D0 D1 D2 D3 D4 D5 D6 D7 D8 D9 D10 D11 D12 D13 D14 D15 CHANnel1 CHANnel2 CHANnel3 CHANnel4 MATH1 MATH2 MATH3 MATH4}	CHANnel1

Remarks

This command has the same function as the *:MEASure:SETup:PSB* command.

D0-D15 are only available for the DHO900 series.

Return Format

The query returns D0, D1, D2, D3, D4, D5, D6, D7, D8, D9, D10, D11, D12, D13, D14, D15, CHAN1, CHAN2, CHAN3, CHAN4, MATH1, MATH2, MATH3, or MATH4.

Example

```
:MEASure:SETup:DSB CHANnel2 /*Sets Source B of the delay
measurement to CHANnel2.*/
:MEASure:SETup:DSB? /*The query returns CHAN2.*/
```

3.17.16 :MEASure:THReshold:SOURce

Syntax

```
:MEASure:THReshold:SOURce <source>
```

```
:MEASure:THReshold:SOURce?
```

Description

Sets or queries the threshold source.

Parameter

Name	Type	Range	Default
<source>	Discrete	{CHANnel1 CHANnel2 CHANnel3 CHANnel4 MATH1 MATH2 MATH3 MATH4}	CHANnel1

Remarks

Modifying the threshold will affect the measurement results of time, delay and phase parameters.

Return Format

The query returns CHAN1, CHAN2, CHAN3, CHAN4, MATH1, MATH2, MATH3, or MATH4.

Example

```
:MEASure:THReshold:SOURce CHANnel2 /*Sets the threshold source
to CHANnel2.*/
:MEASure:THReshold:SOURce? /*The query returns CHAN2.*/
```

3.17.17 :MEASure:THReshold:TYPE**Syntax**

```
:MEASure:THReshold:TYPE <type>
```

```
:MEASure:THReshold:TYPE?
```

Description

Sets or queries the measurement threshold type.

Parameter

Name	Type	Range	Default
<type>	Discrete	{PERCent ABSolute}	PERCent

Remarks

N/A

Return Format

The query returns PERC or ABS.

Example

```
:MEASure:THReshold:TYPE ABSolute /*Sets the threshold type to
ABSolute.*/
:MEASure:THReshold:TYPE? /*The query returns ABS.*/
```

3.17.18 :MEASure:THReshold:DEFault

Syntax

```
:MEASure:THReshold:DEFault
```

Description

Sets the threshold level of the analog channel in auto measurement to a default value.

Parameter

N/A

Remarks

For the default threshold level in absolute, its upper limit and lower limit are + (vertical scale x 3) and -(vertical scale x 3), respectively.

Return Format

N/A

Example

N/A

3.17.19 :MEASure:AREA

Syntax

```
:MEASure:AREA <area>
```

```
:MEASure:AREA?
```

Description

Sets or queries the type of the measurement range.

Parameter

Name	Type	Range	Default
<area>	Discrete	{MAIN ZOOM}	MAIN

Remarks

- **MAIN:** indicates that the measurement range is within the main time base region.

- **ZOOM:** indicates that the measurement range is within the zoomed time base region. Note that only when you enable the delayed sweep function first, can "Zoom" be enabled.

Return Format

The query returns MAIN, ZOOM.

Example

```
:MEASure:AREA ZOOM /*Sets the type of the measurement
range to ZOOM.*/
:MEASure:AREA? /*The query returns ZOOM.*/
```

3.17.20 :MEASure:INDicator

Syntax

```
:MEASure:INDicator <bool>
```

```
:MEASure:INDicator?
```

Description

Sets or queries the on/off status of the measurement auto cursor.

Parameter

Name	Type	Range	Default
<bool>	Bool	{{1 ON}}{0 OFF}}	0 OFF

Remarks

N/A

Return Format

The query returns 1 or 0.

Example

```
:MEASure:INDicator ON /*Sets the measurement auto cursor to be
on.*/
:MEASure:INDicator? /*The query returns 1.*/
```

3.17.21 :MEASure:COUNTER:ENABLE

Syntax

```
:MEASure:COUNTER:ENABLE <bool>
```

```
:MEASure:COUNTER:ENABLE?
```

Description

Sets or queries the on/off status of the frequency counter.

Parameter

Name	Type	Range	Default
<bool>	Bool	{{1 ON}}{0 OFF}}	0 OFF

Remarks

N/A

Return Format

The query returns 1 or 0.

Example

```
:MEASure:COUNter:ENABle ON /*Enables the frequency counter.*/
:MEASure:COUNter:ENABle? /*The query returns 1.*/
```

3.17.22 :MEASure:COUNter:SOURce**Syntax**

```
:MEASure:COUNter:SOURce <source>
```

```
:MEASure:COUNter:SOURce?
```

Description

Sets or queries the measurement source for the frequency counter.

Parameter

Name	Type	Range	Default
<source>	Discrete	{D0 D1 D2 D3 D4 D5 D6 D7 D8 D9 D10 D11 D12 D13 D14 D15 CHANnel1 CHANnel2 CHANnel3 CHANnel4 EXT}	CHANnel1

Remarks

Digital channels (D0 to D15) are only supported by the DHO900 series.

EXT is only available for DHO812 and DHO802.

Return Format

The query returns D0, D1, D2, D3, D4, D5, D6, D7, D8, D9, D10, D11, D12, D13, D14, D15, CHAN1, CHAN2, CHAN3, CHAN4, or EXT.

Example

```
:MEASure:COUNter:SOURce CHANnel4 /*Sets the measurement source of
the frequency counter to CHANnel4.*/
:MEASure:COUNter:SOURce? /*The query returns CHAN4.*/
```

3.17.23 :MEASure:COUNter:VALue?**Syntax**

```
:MEASure:COUNter:VALue?
```

Description

Queries the measurement results of the frequency counter.

Parameter

N/A

Remarks

N/A

Return Format

The query returns the measurement results of the frequency counter in scientific notation.

Example

```
:MEASure:COUNter:VALue? /*The query returns 9.999996E-04.*/
```

3.17.24 :MEASure:AMP:TYPE**Syntax**

```
:MEASure:AMP:TYPE <val>
```

```
:MEASure:AMP:TYPE?
```

Description

Sets or queries the amplitude method.

Parameter

Name	Type	Range	Default
<val>	Discrete	{AUTO MANual}	MANual

Remarks

- **AUTO**: indicates the Auto method.
- **MANual**: indicates the Manual method.

Return Format

The query returns AUTO or MAN.

Example

```
:MEASure:AMP:TYPE MANual /*Sets the amplitude method to MANual.*/
:MEASure:AMP:TYPE? /*The query returns MAN.*/
```

3.17.25 :MEASure:AMP:MANual:TOP**Syntax**

```
:MEASure:AMP:MANual:TOP <val/>
```

```
:MEASure:AMP:MANual:TOP?
```

Description

Sets or queries the amplitude top value type for the manual amplitude method.

Parameter

Name	Type	Range	Default
<val>	Discrete	{HISTogram MAXMin}	HISTogram

Remarks

- **HISTogram:** indicates the histogram type.
- **MAXMin:** indicates the Max-Min type.

Return Format

The query returns HIST or MAXM.

Example

```
:MEASure:AMP:MANual:TOP MAXMin /*Sets the amplitude top value
type for the manual amplitude method to MAXMin.*/
:MEASure:AMP:MANual:TOP? /*The query returns MAXM.*/
```

3.17.26 :MEASure:AMP:MANual:BASE**Syntax**

```
:MEASure:AMP:MANual:BASE <val/>
```

```
:MEASure:AMP:MANual:BASE?
```

Description

Sets or queries the amplitude base value type for the manual amplitude method.

Parameter

Name	Type	Range	Default
<val>	Discrete	{HISTogram MAXMin}	HISTogram

Remarks

- **HISTogram**: indicates the histogram type.
- **MAXMin**: indicates the Max-Min type.

Return Format

The query returns HIST or MAXM.

Example

```
:MEASure:AMP:MANual:BASE MAXMin /*Sets the amplitude base value
type for the manual amplitude method to MAXMin.*/
:MEASure:AMP:MANual:BASE? /*The query returns MAXM.*/
```

3.17.27 :MEASure:CATegory**Syntax**

```
:MEASure:CATegory <val>
```

```
:MEASure:CATegory?
```

Description

Sets or queries the measurement type.

Parameter

Name	Type	Range	Default
<val>	Integer	0 to 2	0

Remarks

0: horizontal; 1: vertical; 2: other.

Return Format

The query returns an integer ranging from 0 to 2.

Example

```
:MEASure:CATegory 1 /*Sets the measurement type to
Vertical.*/
:MEASure:CATegory? /*The query returns 1.*/
```

3.18 :QUICK Command

The **:QUICK** command is used to set and query the relevant parameters for quick operation shortcut keys.

3.18.1 :QUICK:OPERation

Syntax

```
:QUICK:OPERation <type>
```

```
:QUICK:OPERation?
```

Description

Sets or queries the type of the shortcut keys.

Parameter

Name	Type	Range	Default
<type>	Discrete	{SIMage SWAVe SSETup AMEasure SRESet RECORD SSAVe}	SIMage

Remarks

- **SIMage**: indicates the screen image.
- **SWAVe**: indicates the waveform saving.
- **SSETup**: indicates the setup saving.
- **AMEasure**: indicates all measurement.
- **SRESet**: indicates statistics reset.
- **RECORD**: indicates waveform recording.
- **SSAVe**: indicates saving group.

Return Format

The query returns SIM, SWAV, SSET, AME, REC, SSAV, or SRES.

Example

```
:QUICK:OPERation SWAVe /*Sets the type of the shortcut key to  
"save waveform".*/  
:QUICK:OPERation? /*The query returns SWAV.*/
```

3.19 :RECORD Commands

The **:RECORD** commands are used to set and query the parameters related to the waveform recording mode and frames.

Waveform recording/playing function allows you to record and play the waveforms, enabling you to analyze the waveforms better.

3.19.1 :RECORD:WRECORD:ENABLE

Syntax

```
:RECORD:WRECORD:ENABLE <bool>
```

```
:RECORD:WRECORD:ENABLE?
```

Description

Enables or disables the waveform recording function; or queries the on/off status of the waveform recording function.

Parameter

Name	Type	Range	Default
<bool>	Bool	{{1 ON}} {{0 OFF}}	0 OFF

Remarks

N/A

Return Format

The query returns 0 or 1.

Example

```
:RECORD:WRECORD:ENABLE ON /*Enables the waveform recording
function.*/
:RECORD:WRECORD:ENABLE? /*The query returns 1.*/
```

3.19.2 :RECORD:ENABLE

Syntax

```
:RECORD:ENABLE <bool>
```

```
:RECORD:ENABLE?
```

Description

Enables or disables the waveform recording function; or queries the on/off status of the waveform recording function.

Parameter

Name	Type	Range	Default
<bool>	Bool	{{1 ON}}{0 OFF}}	0 OFF

Remarks

This command exists for backwards compatibility. Use the command `:RECORD:WRECORD:ENABLE`.

Return Format

The query returns 0 or 1.

Example

```
:RECORD:ENABLE ON /*Enables the waveform recording function.*/
:RECORD:ENABLE? /*The query returns 1.*/
```

3.19.3 :RECORD:WRECORD:OPERATE

Syntax

```
:RECORD:WRECORD:OPERATE <operate>
```

```
:RECORD:WRECORD:OPERATE?
```

Description

Sets to start the waveform recording, or queries whether the waveform recording starts or stops.

Parameter

Name	Type	Range	Default
<operate>	Discrete	{RUN STOP}	STOP

Remarks

N/A

Return Format

The query returns RUN or STOP.

Example

```
:RECORD:WRECORD:OPERATE RUN /*Sets to start recording
waveforms.*/
:RECORD:WRECORD:OPERATE? /*The query returns RUN.*/
```

3.19.4 :RECORD:START

Syntax

```
:RECORD:START <bool>
```

```
:RECORD:START?
```

Description

Sets to start the waveform recording, or queries whether the waveform recording starts or stops.

Parameter

Name	Type	Range	Default
<bool>	Bool	{{1 ON}} {0 OFF}}	0 OFF

Remarks

This command exists for backwards compatibility. Use the command *:RECORD:WRECORD:OPERate*.

Return Format

The query returns 1 or 0.

Example

```
:RECORD:START ON /*Sets to start recording the waveforms.*/
:RECORD:START? /*The query returns 1.*/
```

3.19.5 :RECORD:WRECORD:FRAMES

Syntax

```
:RECORD:WRECORD:FRAMES <value>
```

```
:RECORD:WRECORD:FRAMES?
```

Description

Sets or queries the number of frames for waveform recording.

Parameter

Name	Type	Range	Default
<value>	Integer	1 to the maximum number of frames that can be recorded currently	1,000

Remarks

N/A

Return Format

The query returns an integer ranging from 1 to the maximum number of frames that can be recorded currently.

Example

```
:RECORD:WRECORD:FRAMES 300 /*Sets the number of recorded frames
to 300.*/
:RECORD:WRECORD:FRAMES? /*The query returns 300.*/
```

3.19.6 :RECORD:FRAMES**Syntax**

```
:RECORD:FRAMES <value>
```

```
:RECORD:FRAMES?
```

Description

Sets or queries the number of frames for waveform recording.

Parameter

Name	Type	Range	Default
<value>	Integer	1 to the maximum number of frames that can be recorded currently	1,000

Remarks

This command exists for backwards compatibility. Use the command *:RECORD:WRECORD:FRAMES*.

Return Format

The query returns an integer ranging from 1 to the maximum number of frames that can be recorded currently.

Example

```
:RECORD:FRAMES 300 /*Sets the number of recorded frames to 300.*/
:RECORD:FRAMES? /*The query returns 300.*/
```

3.19.7 :RECORD:WRECORD:FRAMES:MAX**Syntax**

```
:RECORD:WRECORD:FRAMES:MAX
```

Description

Sets the number of recorded frames to the maximum number of frames.

Parameter

N/A

Remarks

N/A

Return Format

N/A

Example

```
:RECORD:WRECORD:FRAMES:MAX /*Sets the number of recorded frames to the maximum number of frames.*/
```

3.19.8 :RECORD:WRECORD:FMAX?

Syntax

```
:RECORD:WRECORD:FMAX?
```

Description

Queries the maximum number of frames that can be recorded currently.

Parameter

N/A

Remarks

N/A

Return Format

The query returns an integer. The maximum number of frames that can be recorded currently is determined by the current memory depth.

Example

N/A

3.19.9 :RECORD:WRECORD:FINTEVAL

Syntax

```
:RECORD:WRECORD:FINTEVAL <interval>
```

```
:RECORD:WRECORD:FINTEVAL?
```

Description

Sets or queries the time interval between frames in waveform recording.

Parameter

Name	Type	Range	Default
<interval>	Real	10 ns to 1 s	10 ns

Remarks

N/A

Return Format

The query returns the time interval in scientific notation. The unit is s.

Example

```
:RECORD:WRECORD:FINTERVAL 1 /*Sets the time interval between frames
in waveform recording to 1 s.*/
:RECORD:WRECORD:FINTERVAL? /*The query returns 1.000000E0.*/
```

3.19.10 :RECORD:WRECORD:PROMPT**Syntax**

```
:RECORD:WRECORD:PROMPT <bool>
```

```
:RECORD:WRECORD:PROMPT?
```

Description

Sets or queries the on/off status of the beeper when the recording is completed.

Parameter

Name	Type	Range	Default
<bool>	Bool	{{1 ON}}{0 OFF}}	1 ON

Remarks

N/A

Return Format

The query returns 0 or 1.

Example

```
:RECORD:WRECORD:PROMPT ON /*Enables the beeper when the
recording is completed.*/
:RECORD:WRECORD:PROMPT? /*The query returns 1.*/
```

3.19.11 :RECORD:WREPLAY:FCURRENT**Syntax**

```
:RECORD:WREPLAY:FCURRENT <value>
```

:RECORD:WREPLAY:FCURRENT?

Description

Sets or queries the current frame in waveform playing.

Parameter

Name	Type	Range	Default
<value>	Integer	1 to the maximum number of frames recorded	The maximum number of frames recorded

Remarks

N/A

Return Format

The query returns an integer.

Example

```
:RECORD:WREPLAY:FCURRENT 300 /*Sets the current frame for
waveform playing to 300.*/
:RECORD:WREPLAY:FCURRENT? /*The query returns 300.*/
```

3.19.12 :RECORD:CURRENT

Syntax

:RECORD:CURRENT <value>

:RECORD:CURRENT?

Description

Sets or queries the current frame in waveform playing.

Parameter

Name	Type	Range	Default
<value>	Integer	1 to the maximum number of frames recorded	The maximum number of frames recorded

Remarks

This command exists for backwards compatibility. Use the command *:RECORD:WREPLAY:FCURRENT*.

Return Format

The query returns an integer.

Example

```
:RECORD:CURRENT 300 /*Sets the current frame for waveform
playing to 300.*/
:RECORD:CURRENT? /*The query returns 300.*/
```

3.19.13 :RECORD:WREPLAY:FCURRENT:TIME?**Syntax**

```
:RECORD:WREPLAY:FCURRENT:TIME?
```

Description

Queries the time stamp of the current frame in waveform playing.

Parameter

N/A

Remarks

N/A

Return Format

Queries the time stamp of the current frame in strings in waveform playing.

Example

N/A

3.19.14 :RECORD:WREPLAY:FSTART**Syntax**

```
:RECORD:WREPLAY:FSTART <start>
:RECORD:WREPLAY:FSTART?
```

Description

Sets or queries the start frame in waveform playback.

Parameter

Name	Type	Range	Default
<start>	Integer	1 to the maximum number of frames that can be played back currently	-

Remarks

N/A

Return Format

The query returns the start frame in integer.

Example

```
:RECORD:WREPLAY:FSTART 10 /*Sets the start frame in waveform
playing to 10.*/
:RECORD:WREPLAY:FSTART? /*The query returns 10.*/
```

3.19.15 :RECORD:WREPLAY:FEND

Syntax

```
:RECORD:WREPLAY:FEND <end>
```

```
:RECORD:WREPLAY:FEND?
```

Description

Sets or queries the end frame in waveform playback.

Parameter

Name	Type	Range	Default
<end>	Integer	1 to the maximum number of frames recorded	-

Remarks

N/A

Return Format

The query returns the end frame in integer.

Example

```
:RECORD:WREPLAY:FEND 346 /*Sets the end frame for waveform
playing to 346.*/
:RECORD:WREPLAY:FEND? /*The query returns 346.*/
```

3.19.16 :RECORD:WREPLAY:FMAX?

Syntax

```
:RECORD:WREPLAY:FMAX?
```

Description

Queries the maximum number of frames that can be played back currently.

Parameter

N/A

Remarks

N/A

Return Format

The query returns an integer ranging from 0 to the number of frames that have been recorded currently.

Example

N/A

3.19.17 :RECORD:WREPLAY:FINTEVAL

Syntax

```
:RECORD:WREPLAY:FINTEVAL <interval>
```

```
:RECORD:WREPLAY:FINTEVAL?
```

Description

Sets or queries the time interval between frames in waveform playback.

Parameter

Name	Type	Range	Default
<interval>	Real	1 ms to 1 s	-

Remarks

N/A

Return Format

The query returns the time interval in scientific notation. The unit is s.

Example

```
:RECORD WREPLAY:FINTEVAL 1 /*Sets the time interval between frames
in waveform playback to 1 s.*/
:RECORD:WREPLAY:FINTEVAL? /*The query returns 1.000000E0.*/
```

3.19.18 :RECORD:WREPLAY:MODE

Syntax

```
:RECORD:WREPLAY:MODE <mode>
```

```
:RECORD:WREPLAY:MODE?
```

Description

Sets the waveform playback mode to Repeat or Single; queries the waveform playback mode.

Parameter

Name	Type	Range	Default
<mode>	Discrete	{REPeat SINGle}	SINGle

Remarks

N/A

Return Format

The query returns REP or SING.

Example

```
:RECORD:WREPlay:MODE REP /*Sets the playback mode to REP.*/
:RECORD:WREPlay:MODE? /*The query returns REP.*/
```

3.19.19 :RECORD:WREPlay:DIRection**Syntax**

```
:RECORD:WREPlay:DIRection <direction>
```

```
:RECORD:WREPlay:DIRection?
```

Description

Sets or queries the playback direction in waveform playing.

Parameter

Name	Type	Range	Default
<direction>	Discrete	{FORWard BACKward}	FORWard

Remarks

N/A

Return Format

The query returns FORW or BACK.

Example

```
:RECORD:WREPlay:DIRection BACK /*Sets the direction of waveform
playback to BACK.*/
:RECORD:WREPlay:DIRection? /*The query returns BACK.*/
```

3.19.20 :RECORD:WREPLAY:OPERate

Syntax

```
:RECORD:WREPLAY:OPERate <operate>
```

```
:RECORD:WREPLAY:OPERate?
```

Description

Enables or disables the waveform playing function; or queries the on/off status of the waveform playing function.

Parameter

Name	Type	Range	Default
<operate>	Discrete	{RUN STOP}	STOP

Remarks

N/A

Return Format

The query returns RUN or STOP.

Example

```
:RECORD:WREPLAY:OPERate RUN /*Sets to play the waveforms.*/
:RECORD:WREPLAY:OPERate? /*The query returns RUN.*/
```

3.19.21 :RECORD:PLAY

Syntax

```
:RECORD:PLAY <bool>
```

```
:RECORD:PLAY?
```

Description

Enables or disables the waveform playing function; or queries the on/off status of the waveform playing function.

Parameter

Name	Type	Range	Default
<bool>	Bool	{{1 ON}}{0 OFF}}	0 OFF

Remarks

This command exists for backwards compatibility. Use the command *:RECORD:WREPLAY:OPERate*.

Return Format

The query returns 1 or 0.

Example

```
:RECORD:PLAY ON /*Sets to play the waveforms.*/  
:RECORD:PLAY? /*The query returns 1.*/
```

3.19.22 :RECORD:WREPLAY:BACK

Syntax

```
:RECORD:WREPLAY:BACK
```

Description

Plays back the previous frame of waveforms manually.

Parameter

N/A

Remarks

N/A

Return Format

N/A

Example

```
:RECORD:WREPLAY:BACK /*Plays back the previous frame of waveforms  
manually.*/
```

3.19.23 :RECORD:WREPLAY:NEXT

Syntax

```
:RECORD:WREPLAY:NEXT
```

Description

Plays back the next frame of waveforms manually.

Parameter

N/A

Remarks

N/A

Return Format

N/A

Example

```
:RECORD:WREPLAY:NEXT /*Plays back the next frame of waveforms manually.*/
```

3.19.24 :RECORD:WREPLAY:PLAY**Syntax**

```
:RECORD:WREPLAY:PLAY <val>
```

Description

Sets to play from the start frame or end frame manually.

Parameter

Name	Type	Range	Default
<val>	Discrete	{FFIRst FEND}	FFIRst

Remarks

- **FFIRst**: starts from the start frame.
- **FEND**: starts from the end frame.

Return Format

N/A

Example

```
:RECORD:WREPLAY:PLAY FEND /*Sets to play from end frame manually.*/
```

3.20 :REFERENCE COMMANDS

:REFERENCE commands are used to set the reference waveform parameters.

This series oscilloscope provides 10 reference waveform positions (Ref1-Ref10). In the actual test process, you can compare the signal waveform with the reference waveform to locate the failure.

3.20.1 :REFERENCE:SOURce**Syntax**

```
:REFERENCE:SOURce <ref>,<chan>
```

```
:REFERENCE:SOURce? <ref>
```

Description

Sets or queries the source of the specified reference channel.

Parameter

Name	Type	Range	Default
<ref>	Discrete	{1 2 3 4 5 6 7 8 9 10}	-
<chan>	Discrete	{D0 D1 D2 D3 D4 D5 D6 D7 D8 D9 D10 D11 D12 D13 D14 D15 CHANnel1 CHANnel2 CHANnel3 CHANnel4 MATH1 MATH2 MATH3 MATH4}	CHANnel1

Remarks

Only the currently enabled channel can be selected as the source of the specified reference channel.

D0-D15 are only available for the DHO900 series.

Return Format

The query returns D0, D1, D2, D3, D4, D5, D6, D7, D8, D9, D10, D11, D12, D13, D14, D15, CHAN1, CHAN2, CHAN3, CHAN4, MATH1, MATH2, MATH3, or MATH4.

Example

```
:REfERENCE:SOURce 1,CHANnel1 /*Sets the source of the reference
channel 1 to CHANnel1.*/
:REfERENCE:SOURce? 1 /*The query returns CHAN1.*/
```

3.20.2 :REfERENCE:VSCale

Syntax

```
:REfERENCE:VSCale <ref>,<scale>
```

```
:REfERENCE:VSCale? <ref>
```

Description

Sets or queries the vertical scale of the specified reference channel.

Parameter

Name	Type	Range	Default
<ref>	Discrete	{1 2 3 4 5 6 7 8 9 10}	-
<scale>	Real	Refer to <i>Remarks</i>	50mV

Remarks

Related to the probe ratio setting

When the probe ratio is 1X, the value of <scale> ranges from 100 μ V to 10 V. When the probe ratio is 10X, the value of <scale> ranges from 1 mV to 100 V.

This command is only available when the specified reference channel has saved the reference waveforms.

Return Format

The query returns the vertical scale in scientific notation.

Example

```
:REfERENCE:VSCale 1,2 /*Sets the vertical scale of reference
channel 1 to 2 V.*/
:REfERENCE:VSCale? 1 /*The query returns 2.000000E0.*/
```

3.20.3 :REfERENCE:VOFFset

Syntax

```
:REfERENCE:VOFFset <ref>,<offset>
```

```
:REfERENCE:VOFFset? <ref>
```

Description

Sets or queries the vertical position of the specified reference channel.

Parameter

Name	Type	Range	Default
<ref>	Discrete	{1 2 3 4 5 6 7 8 9 10}	-
<offset>	Real	(-10 \times RefVerticalScale) to (10 \times RefVerticalScale)	0 V

Remarks

RefVerticalScale indicates the vertical scale of the currently set reference channel.

Return Format

The query returns the vertical position in scientific notation.

Example

```
:REfERENCE:VOFFset 1,0.5 /*Sets the vertical offset of reference
channel 1 to 500 mV.*/
:REfERENCE:VOFFset? 1 /*The query returns 5.000000E-1.*/
```

3.20.4 :REfERENCE:RESet

Syntax

```
:REfERENCE:RESet <ref>
```

Description

Resets the vertical scale and vertical offset of the specified reference channel to the defaults.

Parameter

Name	Type	Range	Default
<ref>	Discrete	{1 2 3 4 5 6 7 8 9 10}	-

Remarks

N/A

Return Format

N/A

Example

N/A

3.20.5 :REFerence:CURRent

Syntax

:REFerence:CURRent <ref>

Description

Sets the current reference channel.

Parameter

Name	Type	Range	Default
<ref>	Discrete	{1 2 3 4 5 6 7 8 9 10}	1

Remarks

N/A

Return Format

N/A

Example

N/A

3.20.6 :REFerence:SAVE

Syntax

:REFerence:SAVE <ref>

Description

Saves the waveform of the specified reference channel to the internal memory as the reference waveform.

Parameter

Name	Type	Range	Default
<ref>	Discrete	{1 2 3 4 5 6 7 8 9 10}	-

Remarks

N/A

Return Format

N/A

Example

N/A

3.20.7 :REference:COLor

Syntax

```
:REference:COLor <ref>, <color>
```

```
:REference:COLor? <ref>
```

Description

Sets or queries the color of the specified reference channel.

Parameter

Name	Type	Range	Default
<ref>	Discrete	{1 2 3 4 5 6 7 8 9 10}	-
<color>	Discrete	{GRAY GREen BLUE RED ORANge}	-

Remarks

N/A

Return Format

The query returns GRAY, GRE, BLUE, RED, or ORAN.

Example

```
:REference:COLor 1,GREen /*Sets the display color of the
reference channel 1 to GREen.*/
:REference:COLor? 1 /*The query returns GRE.*/
```

3.20.8 :REfERENCE:LABel:ENABle

Syntax

```
:REfERENCE:LABel:ENABle <bool>
```

```
:REfERENCE:LABel:ENABle?
```

Description

Enables or disables the label display of all the reference channels; or queries the on/off label display status of all the reference channels.

Parameter

Name	Type	Range	Default
<bool>	Bool	{{1 ON}} {{0 OFF}}	0 OFF

Remarks

N/A

Return Format

The query returns 1 or 0.

Example

```
:REfERENCE:LABel:ENABle ON /*Enables the label display of
all the reference channels.*/
:REfERENCE:LABel:ENABle? /*The query returns 1.*/
```

3.20.9 :REfERENCE:LABel:CONTent

Syntax

```
:REfERENCE:LABel:CONTent <ref>,<str>
```

```
:REfERENCE:LABel:CONTent? <ref>
```

Description

Sets or queries the label of the specified reference channel.

Parameter

Name	Type	Range	Default
<ref>	Discrete	{1 2 3 4 5 6 7 8 9 10}	-
<str>	ASCII String	The label can contain English letters and numbers, as well as some symbols.	-

Remarks

N/A

Return Format

The query returns the label of the specified reference channel in strings.

Example

```
:REfERENCE:LABel:CONTent 1,REF1          /*Sets the label of
reference channel 1 to REF1.*/
:REfERENCE:LABel:CONTent? 1             /*The query returns REF1.*/
```

3.21 :SAVE Commands

You can save the current setups, waveforms, screen image, and parameters of the oscilloscope to the internal memory or external USB storage device (such as USB storage device) in various formats and recall the stored setups when necessary.

3.21.1 :SAVE:IMAGe:INVert

Syntax

```
:SAVE:IMAGe:INVert <bool>
```

```
:SAVE:IMAGe:INVert?
```

Description

Enables or disables the invert function when saving the image; or queries whether the invert function is enabled when saving the image.

Parameter

Name	Type	Range	Default
<bool>	Bool	{{1 ON}}{0 OFF}	0 OFF

Remarks

N/A

Return Format

The query returns 1 or 0.

Example

```
:SAVE:IMAGe:INVert ON          /*Enables the invert function when
saving the image.*/
:SAVE:IMAGe:INVert?           /*The query returns 1.*/
```

3.21.2 :SAVE:IMAGe:COLor

Syntax

```
:SAVE:IMAGe:COLor <color>
```

```
:SAVE:IMAGe:COLor?
```

Description

Sets the image color for image saving to Color or Gray; or queries image color for image saving.

Parameter

Name	Type	Range	Default
<color>	Discrete	{COLor GRAY}	COLor

Remarks

N/A

Return Format

The query returns COL or GRAY.

Example

```
:SAVE:IMAGe:COLor GRAY /*Sets the image color for image
saving to GRAY.*/
:SAVE:IMAGe:COLor? /*The query returns GRAY.*/
```

3.21.3 :SAVE:IMAGe:FORMat

Syntax

```
:SAVE:IMAGe:FORMat <format>
```

```
:SAVE:IMAGe:FORMat?
```

Description

Sets or queries in what format is the image saved.

Parameter

Name	Type	Range	Default
<format>	Discrete	{PNG BMP JPG}	-

Remarks

N/A

Return Format

The query returns PNG, BMP, or JPG.

Example

```
:SAVE:IMAGe:FORMat PNG /*Sets the storage format to PNG.*/
:SAVE:IMAGe:FORMat? /*The query returns PNG.*/
```

3.21.4 :SAVE:IMAGe:HEADer**Syntax**

```
:SAVE:IMAGe:HEADer <bool>
```

```
:SAVE:IMAGe:HEADer?
```

Description

Sets or queries whether to display the image header.

Parameter

Name	Type	Range	Default
<bool>	Bool	{{1 ON}}{0 OFF}}	-

Remarks

- **1|ON:** enables to display the image header. If you select "ON", the instrument model and the image creation date will be displayed in the header of the image when you save the image file.
- **0|OFF:** disables to display the image header.

Return Format

The query returns 1 or 0.

Example

```
:SAVE:IMAGe:HEADer ON /*Enables the display of the image header.*/
:SAVE:IMAGe:HEADer? /*The query returns 1.*/
```

3.21.5 :SAVE:IMAGe:DATA?**Syntax**

```
:SAVE:IMAGe:DATA?
```

Description

Queries the bitmap data stream of the currently displayed image.

Parameter

N/A

Remarks

The read data format is TMC header + binary data stream of the screenshot + terminator. The TMC header is in #NXXXXXX format; wherein, # is the TMC header identifier; N following # represents the number of digits (in the decimal integer) that follow; the length of the binary data stream of the screenshot is expressed in ASCII strings, and the terminator represents the ending of communication. For example, the data read for one time is #9000387356. 9 indicates the number of digits (in the decimal integer) that follow, and "000387356" indicates the length of the binary data stream, that is, 387356 bytes.

Return Format

The query returns the binary data stream.

Example

```
:SAVE:IMAGe:DATA? /*The query returns the binary data stream.*/
```

3.21.6 :SAVE:IMAGe

Syntax

```
:SAVE:IMAGe <path>
```

Description

Stores the contents displayed on the screen into the internal or external memory in image format.

Parameter

Name	Type	Range	Default
<path>	ASCII String	Refer to <i>Remarks</i>	-

Remarks

<path> includes the file storage location and the filename with a suffix.

- The path of the local disk is C:/ and the path of the external storage device can be D:/E:/...
- The suffix of the filename can be .bmp, .png, or .jpg.

- Refer to *:SAVE:OVERlap*. When you send the command `:SAVE:OVERlap ON`, if the specified storage location already contains a file with the same filename, the original file will be overwritten.
- The filename can contain letters, numbers, and other non-Chinese characters. The length of the filename shall not exceed 16 characters.

Return Format

N/A

Example

```
:SAVE:IMAGe D:/123.png /*Stores the contents displayed on the
screen into the external storage device Disk D, with the filename
123.png.*/*
```

3.21.7 :SAVE:SETup

Syntax

`:SAVE:SETup <path>`

Description

Saves the current setup parameters of the oscilloscope to the internal or external memory as a file.

Parameter

Name	Type	Range	Default
<path>	ASCII String	Refer to <i>Remarks</i>	-

Remarks

<path> includes the file storage location and the filename with a suffix.

- The path of the local disk is C:/ and the path of the external storage device can be D:/E:/...
- The suffix of the filename is "*.stp".
- Refer to *:SAVE:OVERlap*. When you send the command `:SAVE:OVERlap ON`, if the specified storage location already contains a file with the same filename, the original file will be overwritten.
- The filename can contain letters, numbers, and other non-Chinese characters. The length of the filename shall not exceed 16 characters.

Return Format

N/A

Example

```
:SAVE:SETup D:/123.stp /*Stores the current setup parameters of the
oscilloscope into the external storage device Disk D, with the
filename 123.stp.*/*
```

3.21.8 :SAVE:WAVEform**Syntax**

```
:SAVE:WAVEform <path>
```

Description

Saves the waveform data to the internal or external memory as a file.

Parameter

Name	Type	Range	Default
<path>	ASCII String	Refer to <i>Remarks</i>	-

Remarks

<path> includes the file storage location and the filename with a suffix.

- The path of the local disk is C:/ and the path of the external storage device can be D:/E:/...
- The suffix of the filename is "*.bin" or "*.csv".
- Refer to *:SAVE:OVERlap*. When you send the command :SAVE:OVERlap ON, if the specified storage location already contains a file with the same filename, the original file will be overwritten.
- The filename can contain letters, numbers, and other non-Chinese characters. The length of the filename shall not exceed 16 characters.

Return Format

N/A

Example

```
:SAVE:WAVEform D:/123.csv /*Saves the waveform file to the
external storage device Disk D, with the filename 123.csv.*/*
```

3.21.9 :SAVE:MEMory:WAVeform

Syntax

```
:SAVE:MEMory:WAVeform <path>
```

Description

Saves the memory waveform data of the oscilloscope to the specified path as a file.

Parameter

Name	Type	Range	Default
<path>	ASCII String	Refer to <i>Remarks</i>	-

Remarks

<path> includes the file storage location and the filename with a suffix.

- The path of the local disk is C:/ and the path of the external storage device can be D:/E:/...
- The suffix of the filename is "*.bin", "*.csv", or "*.wfm".
- Refer to *:SAVE:OVERlap*. When you send the command :SAVE:OVERlap ON, if the specified storage location already contains a file with the same filename, the original file will be overwritten.
- The filename can contain letters, numbers, and other non-Chinese characters. The length of the filename shall not exceed 16 characters.

Return Format

N/A

Example

```
:SAVE:MEMory:WAVeform D:/123.bin /*Saves the memory waveform data of the oscilloscope to Disk D, with the filename 123.bin.*/
```

3.21.10 :SAVE:STATus?

Syntax

```
:SAVE:STATus?
```

Description

Queries the status of the memory.

Parameter

N/A

Remarks

N/A

Return Format

The query returns 0 or 1 (when the saving operation is completed).

Example

N/A

3.21.11 :SAVE:OVERlap

Syntax

```
:SAVE:OVERlap <bool>
```

```
:SAVE:OVERlap?
```

Description

Sets or queries whether to overwrite the existing file when saving a file.

Parameter

Name	Type	Range	Default
<bool>	Bool	{{1 ON}} {{0 OFF}}	-

Remarks

- **1|ON:** enables to overwrite the existing file. The existing file with the same name as the file to be saved will be overwritten.
- **0|OFF:** disables to overwrite the existing file.

Return Format

The query returns 1 or 0.

Example

```
:SAVE:OVERlap ON /*Enables to overwrite the existing file.*/
:SAVE:OVERlap? /*The query returns 1.*/
```

3.21.12 :SAVE:PREFix

Syntax

```
:SAVE:PREFix <name>
```

:SAVE:PREFix?

Description

Sets or queries the saved prefix of the filename.

Parameter

Name	Type	Range	Default
<name>	ASCII String	Refer to <i>Remarks</i>	-

Remarks

The filename mentioned in this command shall not contain the suffix. Its prefix can contain letters, numbers, and other non-Chinese characters. The length of the prefix shall not exceed 16 characters.

Return Format

The query returns the saved prefix of the filename in strings.

Example

```
:SAVE:PREFix Rigol /*Sets the saved prefix of the filename to
Rigol.*/*
:SAVE:PREFix? /*The query returns Rigol.*/*
```

3.21.13 :LOAD:SETup

Syntax

:LOAD:SETup <path>

Description

Loads the setup file of the oscilloscope from the specified path.

Parameter

Name	Type	Range	Default
<path>	ASCII String	Refer to <i>Remarks</i>	-

Remarks

<path> includes the file storage location and the filename with a suffix.

- The path of the local disk is C:/ and the path of the external storage device can be D:/E:/...
- The suffix of the filename to be loaded is "*.stp".

Return Format

N/A

Example

```
:LOAD:SETup D:/123.stp /*Loads the setup file "123.stp" from
the external storage device Disk D.*/*
```

3.22 :SEARch Commands

3.22.1 :SEARch:COUNT?

Syntax

:SEARch:COUNT?

Description

Queries the total number of the search events.

Parameter

N/A

Remarks

N/A

Return Format

The query returns the total number of the search events in integer.

Example

N/A

3.22.2 :SEARch:STATE

Syntax

:SEARch:STATE <bool>

:SEARch:STATE?

Description

Enables or disables the search function; or queries the on/off status of the search function.

Parameter

Name	Type	Range	Default
<bool>	Bool	{{1 ON}}{0 OFF}}	0 OFF

Return Format

The query returns 1 or 0.

Example

```
:SEARCH:STATE ON /*Enables the search function.*/
:SEARCH:STATE? /*The query returns 1.*/
```

3.22.3 :SEARCH:MODE**Syntax**

```
:SEARCH:MODE <value>
```

```
:SEARCH:MODE?
```

Description

Sets the search type.

Parameter

Name	Type	Range	Default
<value>	Discrete	{EDGE PULSe}	EDGE

Remarks

- **EDGE:** selects "Edge" as the search type.
- **PULSe:** selects "Pulse" as the search type.

Return Format

The query returns EDGE or PULS.

Example

```
:SEARCH:MODE PULSe /*Selects the search type to "PULSe".*/
:SEARCH:MODE? /*The query returns PULS.*/
```

3.22.4 :SEARCH:EVENT**Syntax**

```
:SEARCH:EVENT <value>
```

```
:SEARCH:EVENT?
```

Description

Sets to navigate a search event.

Parameter

Name	Type	Range	Default
<value>	Integer	0 to (the number of searched events – 1)	0

Remarks

N/A

Return Format

The query returns an integer.

Example

```
:SEARCH:EVENT 1 /*Sets to navigate to Search Event 1.*/
:SEARCH:EVENT? /*The query returns 1.*/
```

3.22.5 :SEARCH:VALUE?**Syntax**

```
:SEARCH:VALUE? <X>
```

Description

Queries the time value for the specified Line No. in the marktable.

Parameter

Name	Type	Range	Default
<X>	Integer	-	-

Remarks

<X> denotes the line number of the marktable.

Return Format

The query returns a time value.

Example

N/A

3.22.6 :SEARCH:EDGE:SLOPE**Syntax**

```
:SEARCH:EDGE:SLOPE <slope>
```

```
:SEARCH:EDGE:SLOPE?
```

Description

Sets or queries the edge for the "Edge" search type.

Parameter

Name	Type	Range	Default
<slope>	Discrete	{POSitive NEGative EITHer}	POSitive

Remarks

- **POSitive:** indicates the rising edge.
- **NEGative:** indicates the falling edge.
- **EITHer:** indicates the rising edge or the falling edge.

Return Format

The query returns POS, NEG, or EITH.

Example

```
:SEARCH:EDGE:SLOPe NEGative /*Sets the edge type to NEGative.*/
:SEARCH:EDGE:SLOPe? /*The query returns NEG.*/
```

3.22.7 :SEARCh:EDGE:SOURce**Syntax**

```
:SEARCh:EDGE:SOURce <source>
```

```
:SEARCh:EDGE:SOURce?
```

Description

Sets or queries the source for the "Edge" search type.

Parameter

Name	Type	Range	Default
<source>	Discrete	{CHANnel1 CHANnel2 CHANnel3 CHANnel4}	CHANnel1

Remarks

N/A

Return Format

The query returns CHAN1, CHAN2, CHAN3, or CHAN4.

Example

```
:SEARCH:EDGE:SOURce CHANnel1 /*Sets the source for the Edge
search type to CHANnel1.*/
:SEARCH:EDGE:SOURce? /*The query returns CHAN1.*/
```

3.22.8 :SEARCH:EDGE:THReshold**Syntax**

```
:SEARCH:EDGE:THReshold <thre>
```

```
:SEARCH:EDGE:THReshold?
```

Description

Sets or queries the threshold for the "Edge" search type.

Parameter

Name	Type	Range	Default
<thre>	Real	(-4.5 x VerticalScale - Offset) to (4.5 x VerticalScale - Offset)	0.000V

Remarks

N/A

Return Format

The query returns the threshold for the edge search type in scientific notation.

Example

```
:SEARCH:EDGE:THReshold 0.01 /*Sets the threshold to 0.01
V.*/
:SEARCH:EDGE:THReshold? /*The query returns 1.000000E-2.*/
```

3.22.9 :SEARCH:PULSe:POLarity**Syntax**

```
:SEARCH:PULSe:POLarity <polarity>
```

```
:SEARCH:PULSe:POLarity?
```

Description

Sets or queries the polarity for the "Pulse" search type.

Parameter

Name	Type	Range	Default
<polarity>	Discrete	{POSitive NEGative}	POSitive

Remarks

N/A

Return Format

The query returns POS or NEG.

Example

```
:SEARCH:PULSE:POLarity POSitive /*Sets the polarity for the
Pulse search type to POSitive.*/
:SEARCH:PULSE:POLarity? /*The query returns POS.*/
```

3.22.10 :SEARCH:PULSE:QUALifier**Syntax**

```
:SEARCH:PULSE:QUALifier <qualifier>
```

```
:SEARCH:PULSE:QUALifier?
```

Description

Sets or queries the search condition for the "Pulse" search type.

Parameter

Name	Type	Range	Default
<qualifier>	Discrete	{GREater LESS GLESs}	GREater

Remarks

- **GREater:** the positive/negative pulse width of the input signal is greater than the specified pulse width.
- **LESS:** the positive/negative pulse width of the input signal is smaller than the specified pulse width.
- **GLESs:** the positive/negative pulse width of the input signal is greater than the specified lower limit of pulse width and smaller than the specified upper limit of pulse width.

Return Format

The query returns GRE, LESS, or GLES.

Example

```
:SEARCH:PULSE:QUALifier LESS /*Sets the search condition for the
"Pulse" search type to LESS.*/
:SEARCH:PULSE:QUALifier? /*The query returns LESS.*/
```

3.22.11 :SEARch:PULSe:SOURce

Syntax

```
:SEARch:PULSe:SOURce <source>
```

```
:SEARch:PULSe:SOURce?
```

Description

Sets or queries the source for the "Pulse" search type.

Parameter

Name	Type	Range	Default
<source>	Discrete	{CHANnel1 CHANnel2 CHANnel3 CHANnel4}	CHANnel1

Remarks

N/A

Return Format

The query returns CHAN1, CHAN2, CHAN3, or CHAN4.

Example

```
:SEARch:PULSe:SOURce CHANnel1 /*Sets the source for the Pulse
search type to CHANnel1.*/
:SEARch:PULSe:SOURce? /*The query returns CHAN1.*/
```

3.22.12 :SEARch:PULSe:UWIDth

Syntax

```
:SEARch:PULSe:UWIDth <width>
```

```
:SEARch:PULSe:UWIDth?
```

Description

Sets or queries the upper limit of the pulse width for the "Pulse" search type.

Parameter

Name	Type	Range	Default
<width>	Real	800 ps to 10 s	2 us

Remarks

N/A

Return Format

The query returns the upper limit of the pulse width in scientific notation.

Example

```
:SEARCH:PULSE:UWIDTH 1 /*Sets the upper limit of the pulse width
for the Pulse search type to 1 s.*/
:SEARCH:PULSE:UWIDTH? /*The query returns 1.000000E0.*/
```

3.22.13 :SEARCH:PULSE:LWIDTH**Syntax**

```
:SEARCH:PULSE:LWIDTH <width>
```

```
:SEARCH:PULSE:LWIDTH?
```

Description

Sets or queries the lower limit of the pulse width for the "Pulse" search type.

Parameter

Name	Type	Range	Default
<width>	Real	800 ps to 10 s	1 us

Remarks

N/A

Return Format

The query returns the lower limit of the pulse width in scientific notation.

Example

```
:SEARCH:PULSE:LWIDTH 0.2 /*Sets the lower limit of the pulse
width for the Pulse search type to 200 ms.*/
:SEARCH:PULSE:LWIDTH? /*The query returns 2.000000E-1.*/
```

3.22.14 :SEARCH:PULSE:THReshold**Syntax**

```
:SEARCH:PULSE:THReshold <thre>
```

```
:SEARCH:PULSE:THReshold?
```

Description

Sets or queries the threshold for the "Pulse" search type.

Parameter

Name	Type	Range	Default
<thre>	Real	(-5 × VerticalScale - OFFSet) to (5 × VerticalScale - OFFSet)	0.000 V

Remarks

N/A

Return Format

The query returns the threshold for the pulse search type in scientific notation.

Example

```
:SEARCH:PULSe:THReshold 0.01 /*Sets the threshold to 10
mV.*/
:SEARCH:PULSe:THReshold? /*The query returns
1.000000E-2.*/
```

3.23 :NAVigate Commands

3.23.1 :NAVigate:ENABLE

Syntax

```
:NAVigate:ENABLE <bool>
```

```
:NAVigate:ENABLE?
```

Description

Sets or queries the on/off status of the Navigation function.

Parameter

Name	Type	Range	Default
<bool>	Bool	{{1 ON}} {{0 OFF}}	0 OFF

Remarks

N/A

Return Format

The query returns 1 or 0.

Example

```
:NAVigate:ENABLE ON /*Enables the Navigation function.*/
:NAVigate:ENABLE? /*The query returns 1.*/
```

3.23.2 :NAVigate:MODE

Syntax

```
:NAVigate:MODE <mode>
```

```
:NAVigate:MODE?
```

Description

Sets or queries the navigation mode.

Parameter

Name	Type	Range	Default
<mode>	Discrete	{TIME SEARCh FRAMe}	TIME

Remarks

- **TIME:** indicates the time navigation. It is available only when in "YT" time mode.
- **SEARCh:** indicates event search navigation. After searching events using the Search function, you can select the "Search Event" mode in Navigation menu to navigate to specific events in the marktable.
- **FRAMe:** indicates frame segment navigation. This mode is available only in UltraAcquire acquisition mode. When UltraAcquire is enabled, the Mode is automatically set to "Frame Segment" which cannot be modified.

The navigation function is available only when the oscilloscope is in "STOP" state (acquisition stopped). You can send the **:STOP** command to set the oscilloscope to STOP status.

Return Format

The query returns TIME, SEARCh, or FRAMe.

Example

```
:NAVigate:MODE TIME /*Sets the navigation mode to TIME.*/
:NAVigate:MODE? /*The query returns TIME.*/
```

3.23.3 :NAVigate:TIME:SPEEd

Syntax

```
:NAVigate:TIME:SPEEd <speed>
```

```
:NAVigate:TIME:SPEEd?
```

Description

Sets the speed of playing the waveforms in time navigation mode.

Parameter

Name	Type	Range	Default
<speed>	Discrete	{HIGH NORMAL LOW}	NORMAL

Remarks

- **HIGH:** indicates playing the waveforms at a high speed.
- **NORMAL:** indicates playing the waveforms at a normal speed.
- **LOW:** indicates playing the waveforms at a low speed.

Return Format

The query returns HIGH, NORMAL, or LOW.

Example

```
:NAVigate:TIME:SPEEd LOW /*Sets to play the waveforms in time
navigation mode at a low speed.*/
:NAVigate:TIME:SPEEd? /*The query returns LOW.*/
```

3.23.4 :NAVigate:TIME:PLAY

Syntax

```
:NAVigate:TIME:PLAY <bool>
```

```
:NAVigate:TIME:PLAY?
```

Description

Sets or queries whether to play the waveforms in time navigation mode.

Parameter

Name	Type	Range	Default
<bool>	Bool	{{1 ON}} {{0 OFF}}	0 OFF

Remarks

- **1|ON:** starts playing the waveforms.
- **0|OFF:** stops playing the waveforms.

Return Format

The query returns 0 or 1.

Example

```
:NAVigate:TIME:PLAY ON /*Sets to play the waveforms in time
navigation.*/*
:NAVigate:TIME:PLAY? /*The query returns 1.*/*
```

3.23.5 :NAVigate:TIME:END

Syntax

```
:NAVigate:TIME:END
```

Description

Sets to navigate to the end waveforms (waveforms ending at the rightmost end of screen) in time navigation mode.

Parameter

N/A

Remarks

N/A

Return Format

N/A

Example

```
N/A
```

3.23.6 :NAVigate:TIME:START

Syntax

```
:NAVigate:TIME:START
```

Description

Sets to navigate to the start waveform (waveform starting at the leftmost end of screen) in time navigation mode.

Parameter

N/A

Remarks

N/A

Return Format

N/A

Example

N/A

3.23.7 :NAVigate:TIME:NEXT**Syntax**`:NAVigate:TIME:NEXT`**Description**

Sets to play forward the waveform in time navigation mode.

Parameter

N/A

Remarks

N/A

Return Format

N/A

Example

N/A

3.23.8 :NAVigate:TIME:BACK**Syntax**`:NAVigate:TIME:BACK`**Description**

Sets to play backward the waveform in time navigation mode.

Parameter

N/A

Remarks

N/A

Return Format

N/A

Example

N/A

3.23.9 :NAVigate:SEARch:END

Syntax

```
:NAVigate:SEARch:END
```

Description

Sets to navigate to the last event.

Parameter

N/A

Remarks

N/A

Return Format

N/A

Example

```
N/A
```

3.23.10 :NAVigate:SEARch:START

Syntax

```
:NAVigate:SEARch:START
```

Description

Sets to navigate to the first event.

Parameter

N/A

Remarks

N/A

Return Format

N/A

Example

```
N/A
```

3.23.11 :NAVigate:SEARch:NEXT

Syntax

```
:NAVigate:SEARch:NEXT
```

Description

Sets to navigate to the next event.

Parameter

N/A

Remarks

N/A

Return Format

N/A

Example

N/A

3.23.12 :NAVigate:SEARch:BACK

Syntax

```
:NAVigate:SEARch:BACK
```

Description

Sets to navigate to the previous event.

Parameter

N/A

Remarks

N/A

Return Format

N/A

Example

N/A

3.23.13 :NAVigate:FRAMe:DISPlay:MODE

Syntax

```
:NAVigate:FRAMe:DISPlay:MODE <mode>
```

```
:NAVigate:FRAMe:DISPlay:MODE?
```

Description

Sets or queries the display mode in Frame Segment navigation.

Parameter

Name	Type	Range	Default
<mode>	Discrete	{ADJacent OVERlay WATERfall PERSpective MOSaic}	-

Remarks

- **ADJacent:** indicates the adjacent display. Waveform segments are shown in adjacent display, with each segment shown next to the previous segment. In this mode, a maximum of 100 frames of waveforms can be displayed on the screen at a time.
- **OVERlay:** indicates the overlay display. All the captured waveform segments are overwritten to display as one single segment of the waveform. In this mode, a maximum of 100 frames of waveforms can be displayed on the screen at a time.
- **WATERfall:** indicates the waterfall display. It displays the captured waveform segments in a cascaded display order. In this mode, a maximum of 100 frames of waveforms can be displayed on the screen at a time.
- **PERSpective:** indicates the perspective display. The waveform segments are displayed in the ladder-like form, with each segment being arranged above another with a certain perspective (angle), moving up like a rising slope. In this mode, a maximum of 100 frames of waveforms can be displayed on the screen at a time.
- **MOSaic:** indicates the mosaic display. The whole waveform view is divided into several blocks, and each waveform segment is displayed in each block in sequence. In this mode, a maximum of 80 frames of waveforms can be displayed on the screen at a time.

Return Format

The query returns ADJ, OVER, WAT, PERS, or MOS.

Example

```
:NAVigate:FRAME:DISPlay:MODE ADJacent /*Sets the display mode to
ADJacent in Frame Segment navigation.*/
:NAVigate:FRAME:DISPlay:MODE? /*The query returns ADJ.*/
```

3.23.14 :NAVigate:FRAME:END:FRAME

Syntax

```
:NAVigate:FRAME:END:FRAME <frame>
```

```
:NAVigate:FRAME:END:FRAME?
```

Description

Sets or queries the end frame in Frame Segment navigation mode.

Parameter

Name	Type	Range	Default
<frame>	Integer	-	-

Remarks

The range of the end frame is from Start Frame to the maximum number of the frames acquired in UltraAcquire acquisition mode. You can send the `:ACQUIRE:ULTRA:MAXFrame` command to query the maximum number of frames that can be set for UltraAcquire acquisition mode.

When you click or tap the Play key, it plays from the "Start Frame". The number of frames that can be displayed on the current screen page is (End Frame - Start Frame + 1). For example, if you set Start Frame to 3 and End Frame to 9, it will play from the 3rd frame and displays 7 frames on one screen page.

Return Format

The query returns an integer.

Example

```
:NAVigate:FRAME:END:FRAME 8 /*Sets the end frame in Frame Segment
navigation to 8.*/
:NAVigate:FRAME:END:FRAME? /*The query returns 8.*/
```

3.23.15 :NAVigate:FRAME:START:FRAME

Syntax

```
:NAVigate:FRAME:START:FRAME <frame>
```

```
:NAVigate:FRAME:START:FRAME?
```

Description

Sets or queries the start frame in Frame Segment navigation.

Parameter

Name	Type	Range	Default
<frame>	Integer	-	-

Remarks

When you click or tap the Play key, it plays from the "Start Frame". The number of frames that can be displayed on the current screen page is (End Frame - Start Frame + 1). For example, if you set Start Frame to 3 and End Frame to 9, it will play from the 3rd frame and displays 7 frames on one screen page.

Return Format

The query returns an integer.

Example

```
:NAVigate:FRAME:START:FRAME 3 /*Sets the start frame in Frame
Segment navigation to 3.*/
:NAVigate:FRAME:START:FRAME? /*The query returns 3.*/
```

3.23.16 :NAVigate:FRAME:END**Syntax**

```
:NAVigate:FRAME:END
```

Description

Sets to play the final page in Frame Segment navigation mode.

Parameter

N/A

Remarks

N/A

Return Format

N/A

Example

N/A

3.23.17 :NAVigate:FRAME:START**Syntax**

```
:NAVigate:FRAME:START
```

Description

Sets to play the first page in Frame Segment navigation mode.

Parameter

N/A

Remarks

N/A

Return Format

N/A

Example

N/A

3.23.18 :NAVigate:FRAMe:NEXT

Syntax

:NAVigate:FRAMe:NEXT

Description

Sets to play the next page in Frame Segment navigation mode.

Parameter

N/A

Remarks

N/A

Return Format

N/A

Example

N/A

3.23.19 :NAVigate:FRAMe:BACK

Syntax

:NAVigate:FRAMe:BACK

Description

Sets to play the previous page in Frame Segment navigation mode.

Parameter

N/A

Remarks

N/A

Return Format

N/A

Example

N/A

3.23.20 :NAVigate:FRAMe:PLAY

Syntax`:NAVigate:FRAMe:PLAY <bool>``:NAVigate:FRAMe:PLAY?`**Description**

Sets or queries whether to play the waveforms in Frame Segment navigation mode.

Parameter

Name	Type	Range	Default
<bool>	Bool	{{1 ON}}{0 OFF}}	0 OFF

Remarks

- **1|ON:** starts playing the waveforms.
- **0|OFF:** stops playing the waveforms.

During playing in Frame Segment navigation mode, you are not allowed to set the Start Frame and the End Frame.

Return Format

The query returns 1 or 0.

Example

```
:NAVigate:FRAMe:PLAY ON /*Sets to play the waveforms in Frame
Segment navigatio mode.*/
:NAVigate:FRAMe:PLAY? /*The query returns 1.*/
```

3.24 :SYSTem Commands

The **:SYSTem** commands are used to set the system-related parameters.

3.24.1 :SYSTem:AOUTput

Syntax

```
:SYSTem:AOUTput <auxoutput>
```

```
:SYSTem:AOUTput?
```

Description

Sets or queries the type of the signal output from the rear-panel [AUX OUT] connector.

Parameter

Name	Type	Range	Default
<auxoutput>	Discrete	{TOUT PFAil}	TOUT

Remarks

- **TOUT:** after you select this type, the oscilloscope initiates a trigger and then a signal which reflects the current capture rate of the oscilloscope can be output from the connector.
- **PFAil:** after you select this type, a pulse signal will be output from the connector once the oscilloscope detects a successful or failed event.

Return Format

The query returns TOUT or PFA.

Example

```
:SYSTem:AOUTput PFAil /*Sets the signal type to PFAil.*/
:SYSTem:AOUTput? /*The query returns PFA.*/
```

3.24.2 :SYSTem:BEEPer

Syntax

```
:SYSTem:BEEPer <bool>
```

```
:SYSTem:BEEPer?
```

Description

Turns on or off the beeper or queries the on/off status of the beeper.

Parameter

Name	Type	Range	Default
<bool>	Bool	{{1 ON}} {{0 OFF}}	0 OFF

Remarks

N/A

Return Format

The query returns 1 or 0.

Example

```
:SYSTem:BEEPer ON /*Enables the beeper.*/
:SYSTem:BEEPer? /*The query returns 1.*/
```

3.24.3 :SYSTem:ERRor[:NEXT]?**Syntax**

```
:SYSTem:ERRor[:NEXT]?
```

Description

Queries and clears the error queue message.

Parameter

N/A

Remarks

N/A

Return Format

The query is in <Message Number>, <Message Content> format. Wherein, <Message Number> is an integer; <Message Content> is a double-quoted ASCII string. For example, -113, "Undefined header; command cannot be found".

Example

N/A

3.24.4 :SYSTem:PON**Syntax**

```
:SYSTem:PON <power_on>
```

```
:SYSTem:PON?
```

Description

Sets or queries the configuration type recalled by the oscilloscope when it is powered on again after power-off.

Parameter

Name	Type	Range	Default
<power_on>	Discrete	{LATest DEFault}	DEFault

Remarks

N/A

Return Format

The query returns LAT or DEF.

Example

```
:SYSTem:PON LATest /*Sets the oscilloscope to recall Last
value after it is powered on again.*/
:SYSTem:PON? /*The query returns LAT.*/
```

3.24.5 :SYSTem:PSTatus

Syntax

```
:SYSTem:PSTatus <sat>
```

```
:SYSTem:PSTatus?
```

Description

Sets or queries the power status of the oscilloscope.

Parameter

Name	Type	Range	Default
<sat>	Discrete	{DEFault OPEN}	OPEN

Remarks

- **DEFault:** after the oscilloscope is powered on, you need to press the Power key on the front panel to start the oscilloscope.
- **OPEN:** after the oscilloscope is powered on, it starts directly. You do not have to press the Power key.

Return Format

The query returns DEF or OPEN.

Example

```
:SYSTem:PSTatus DEFault /*Sets the power status to DEFault.*/
:SYSTem:PSTatus? /*The query returns DEF.*/
```

3.24.6 :SYSTem:RAMount?

Syntax

:SYSTem:RAMount?

Description

Queries the number of analog channels of the current instrument.

Parameter

N/A

Remarks

N/A

Return Format

The query returns the number of analog channels of the current instrument in integer.

Example

N/A

3.24.7 :SYSTem:RESet

Syntax

:SYSTem:RESet

Description

Resets the system to power on.

Parameter

N/A

Remarks

N/A

Return Format

N/A

Example

N/A

3.24.8 :SYSTem:SETup

Syntax

:SYSTem:SETup <setup_data>

:SYSTem:SETup?

Description

Sends or reads the data stream of the system setup file.

Parameter

Name	Type	Range	Default
<setup_data>	Binary	Refer to <i>Remarks</i>	-

Remarks

- <setup_data> is a binary data block, which consists of the TMC data block header and setup data.
 - The format of the TMC data block header is #NX...X. Wherein, # is the start identifier of the data stream; the N-digit data "X...X" (N≤9) following the start identifier indicate the length of the data stream (the number of bytes).
For example, 9000002506
Wherein, N is 9, 000002506 following it represents that the data stream contains 2506 bytes of effective data.
 - The setup data are expressed in ASCII format.
- When sending the command, directly place the data stream after the command string, then complete the whole sending process in one time. When reading the data stream, ensure that there is enough buffer space to receive the data stream; otherwise, errors might occur in reading the program.

Return Format

N/A

Example

N/A

3.24.9 :SYSTem:LOCKed

Syntax

:SYSTem:LOCKed <bool>

:SYSTem:LOCKed?

Description

Enables or disables the front-panel key operation and touch screen operation; queries whether the front-panel key operation and touch screen operation are locked.

Parameter

Name	Type	Range	Default
<bool>	Bool	{{1 ON}}{0 OFF}}	0 OFF

Remarks

N/A

Return Format

The query returns 1 or 0.

Example

```
:SYSTem:LOCKed ON /*Disables the front-panel key operation
and touch screen operation.*/
:SYSTem:LOCKed? /*The query returns 1.*/
```

3.24.10 :SYSTem:MODules?**Syntax**

```
:SYSTem:MODules?
```

Description

Queries the hardware modules.

Parameter

N/A

Remarks

N/A

Return Format

The query returns 1,0,0,0,0. The first figure indicates LA; the second figure indicates DG; and the others are not defined currently. 1 indicates available, and 0 indicates not available.

Example

N/A

3.24.11 :SYSTem:AUToscale**Syntax**

```
:SYSTem:AUToscale <bool>
```

```
:SYSTem:AUToscale?
```

Description

Enables or disables the function of the Auto menu; or queries the on/off status of the Auto menu.

Parameter

Name	Type	Range	Default
<bool>	Bool	{{1 ON}}{0 OFF}}	1 ON

Remarks

- You can send this command or use the menu key to disable the function of the **AUTO** key.
- After the function of the **AUTO** key is disabled, you cannot perform the Auto Scale operation.

Return Format

The query returns 1 or 0.

Example

```
:SYSTem:AUToscale ON /*Enables the function of the front-panel
AUTO key.*/
:SYSTem:AUToscale? /*The query returns 1.*/
```

3.24.12 :SYSTem:GAMount?**Syntax**

```
:SYSTem:GAMount?
```

Description

Queries the number of grids in the horizontal direction of the screen.

Parameter

N/A

Remarks

N/A

Return Format

The query returns the number of grids in integer. For this oscilloscope, the query returns a fixed value 10.

Example

```
N/A
```

3.24.13 :SYSTem:VERSion?

Syntax

```
:SYSTem:VERSion?
```

Description

Queries the version number of the SCPI used by the system.

Parameter

N/A

Remarks

N/A

Return Format

The query returns the SCPI version number in strings.

Example

```
:SYSTem:VERSion? /*The query returns 3.0.*/
```

3.24.14 :SYSTem:DGStatus?

Syntax

```
:SYSTem:DGStatus?
```

Description

Queries whether the DG module exists.

Parameter

N/A

Remarks

N/A

Return Format

The query returns 1 or 0.

Example

```
:SYSTem:DGStatus? /*The query returns 1 if the instrument has installed the DG module; otherwise, it returns 0.*/
```

3.24.15 :SYSTem:KEYBOARDCheck?

Syntax

```
:SYSTem:KEYBOARDCheck?
```

Description

Queries the status of the keyboard.

Parameter

N/A

Remarks

N/A

Return Format

The query returns true or false.

Example

N/A

3.25 :SOURce Commands

:SOURce commands are used to set AFG parameters.

This series oscilloscope has a standard built-in 25 MHz AFG, which integrates the signal source and the oscilloscope into one.



NOTE

The commands are only available for DHO914S and DHO924S.

3.25.1 :SOURce:OUTPut:STATe

Syntax

```
:SOURce:OUTPut:STATe <bool>
```

```
:SOURce:OUTPut:STATe?
```

Description

Enables or disables the channel output; or queries the channel output status.

Parameter

Name	Type	Range	Default
<bool>	Bool	{{1 ON}} {{0 OFF}}	0 OFF

Remarks

N/A

Return Format

The query returns 0 or 1.

Examples

```
:SOURce:OUTPut:STATe ON /*Enables the channel output for AFG.*/
:SOURce:OUTPut:STATe? /*The query returns 1.*/
```

3.25.2 :SOURce:FUNCTION

Syntax

```
:SOURce:FUNCTION <wave>
```

```
:SOURce:FUNCTION?
```

Description

Sets or queries the function of the basic waveform.

Parameter

Name	Type	Range	Default
<wave>	Discrete	{SINusoid SQUare RAMP DC NOISe ARB}	SINusoid

Remarks

The built-in Function/Arbitrary Waveform Generator of this series can output a variety of basic waveforms, including Sine, Square, Ramp, DC, Noise, and Arb.

Return Format

The query returns SIN, SQU, RAMP, DC, NOIS, or ARB.

Example

```
:SOURce:FUNCTION SQUare /*Sets the output waveform type to Square.*/
:SOURce:FUNCTION? /*The query returns SQU.*/
```

3.25.3 :SOURce:FREQUENCY

Syntax

```
:SOURce:FREQUENCY <freq>
```

```
:SOURce:FREQUENCY?
```

Description

Sets or queries the frequency of basic waveforms.

Parameter

Name	Type	Range	Default
<freq>	Real	Refer to <i>Remarks</i>	1 kHz

Remarks

- Sine: 2 mHz to 25 MHz
- Square: 2 mHz to 15 MHz
- Ramp: 2 mHz to 150 kHz
- Arb: 2 mHz to 10 MHz
- DC and Noise: no frequency parameter

You can use `:SOURce:FUNCtion` to set or query the basic wave type.

Return Format

The query returns the frequency in scientific notation, for example, 2.000000E+5.

Example

```
:SOURce:FREQuency 1000 /*Sets the frequency of the basic waveform
to 1 kHz.*/
:SOURce:FREQuency? /*The query returns 1.000000E+3.*/
```

3.25.4 :SOURce:PHASe

Syntax

`:SOURce:PHASe <phase>`

`:SOURce:PHASe?`

Description

Sets or queries the starting phase of basic waveforms.

Parameter

Name	Type	Range	Default
<phase>	Real	0° to 360°	0°

Remarks

N/A

Return Format

The query returns the starting phase in scientific notation. For example, the query might return 1.0000000000E+01, indicating that the starting phase is 10°.

Example

```
:SOURce:PHASe 10 /*Sets the starting phase of basic waveforms to 10°.*/  
:SOURce:PHASe? /*The query returns 1.0000000000E+01.*/*
```

3.25.5 :SOURce:FUNCtion:RAMP:SYMMetry**Syntax**

```
:SOURce:FUNCtion:RAMP:SYMMetry <symm>  
:SOURce:FUNCtion:RAMP:SYMMetry?
```

Description

Sets or queries the symmetry of Ramp.

Parameter

Name	Type	Range	Default
<symm>	Real	0% to 100%	50%

Remarks

This command is available only when the waveform function (*:SOURce:FUNCtion*) is set to Ramp.

Symmetry is defined as the percentage of the amount of time Ramp wave is rising in the period.

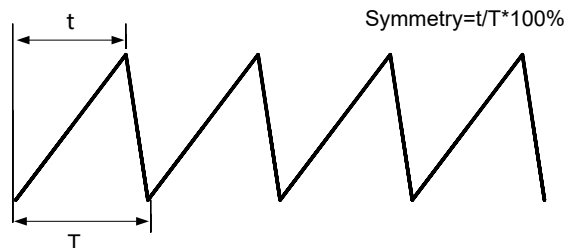
**Return Format**

The query returns the symmetry in scientific notation. For example, the query might return 5.5000000000E+01, indicating that the Ramp symmetry is 55%.

Example

```
:SOURce:FUNCtion:RAMP:SYMMetry 55 /*Sets the symmetry of Ramp to 55%.*/  
:SOURce:FUNCtion:RAMP:SYMMetry? /*The query returns 5.5000000000E+01.*/*
```

3.25.6 :SOURce:FUNCTION:SQUare:DUYT

Syntax

```
:SOURce:FUNCTION:SQUare:DUYT <percent>
```

```
:SOURce:FUNCTION:SQUare:DUYT?
```

Description

Sets or queries the duty cycle of the square wave generated by the AFG function.

Parameter

Name	Type	Range	Default
<percent>	Real	0 to 100	50

Remarks

This command is valid only when the wave type is set to "Square". You can use *:SOURce:FUNCTION* to set or query the waveform type.

Square duty cycle is the percentage of time that the square wave is at a high level over the period of the square wave.

Return Format

The query returns the duty cycle in scientific notation.

Example

```
:SOURce:FUNCTION:SQUare:DUYT 55 /*Sets the square duty cycle to 55%.*/
:SOURce:FUNCTION:SQUare:DUYT? /*The query returns 5.5000000000E+01.*/
```

3.25.7 :SOURce:VOLTage:AMPLitude

Syntax

```
:SOURce:VOLTage:AMPLitude <amp>
```

```
:SOURce:VOLTage:AMPLitude
```

Description

Sets or queries the amplitude of basic waveforms. The default unit is V.

Parameter

Name	Type	Range	Default
<amp>	Real	Refer to <i>Remarks</i>	6 V

Remarks

The amplitude range of basic waveforms is related to the frequency:

- 2 mV to 10 V (frequency \leq 10 MHz)
- 2 mV to 5 V (frequency $>$ 10 MHz)

You can use `:SOURce:FREQuency` to set or query the frequency of the basic waveform.

Return Format

The query returns the amplitude in scientific notation. The unit is V.

Example

```
:SOURce:VOLTagE:AMPLitude 1 /*Sets the amplitude to 1 V.*/
:SOURce:VOLTagE:AMPLitude? /*The query returns 1.0000000000E+00.*/
```

3.25.8 :SOURce:VOLTagE:OFFSet**Syntax**

```
:SOURce:VOLTagE:OFFSet <offset>
:SOURce:VOLTagE:OFFSet?
```

Description

Sets or queries the offset of basic waveforms. The default unit is V.

Parameter

Name	Type	Range	Default
<offset>	Real	Refer to <i>Remarks</i>	0 V

Remarks

The offset range of basic waveforms is related to the amplitude:

Offset range = \pm (maximum amplitude that can be set - current amplitude)/2

For example,

- If the frequency of the current basic waveform is 5 MHz, the maximum amplitude that can be set is 10 V, and the set amplitude is 6 V, then the offset range is $\pm(10\text{ V} - 6\text{ V})/2 = \pm 2\text{ V}$.
- If the frequency of the current basic waveform is 15 MHz, the maximum amplitude that can be set is 5 V, and the set amplitude is 3 V, then the offset range is $\pm(5\text{ V} - 3\text{ V})/2 = \pm 1\text{ V}$.

You can use `:SOURce:VOLTage:AMPLitude` to set or query the amplitude of the basic waveform.

Return Format

The query returns the offset in scientific notation. The unit is V.

Example

```
:SOURce:VOLTage:OFFSet 0.2 /*Sets the waveform offset to 200 mV.*/
:SOURce:VOLTage:OFFSet? /*The query returns 2.0000000000E-01.*/
```

3.25.9 :SOURce:MOD:STATe

Syntax

```
:SOURce:MOD:STATe <bool>
```

```
:SOURce:MOD:STATe?
```

Description

Enables or disables the modulation output; or queries the modulation output status.

Parameter

Name	Type	Range	Default
<bool>	Bool	{{1 ON}}{0 OFF}}	0 OFF

Remarks

N/A

Return Format

The query returns 1 or 0.

Example

```
:SOURce:MOD:STATe /*Enables the modulation output*/
:SOURce:MOD:STATe? /*The query returns 1.*/
```

3.25.10 :SOURce:MOD:TYPE

Syntax

```
:SOURce:MOD:TYPE <type>
```

```
:SOURce:MOD:TYPE?
```

Description

Sets or queries the modulation type.

Parameter

Name	Type	Range	Default
<type>	Discrete	{AM FM PM}	AM

Remarks

- **AM:** amplitude modulation. The amplitude of the carrier waveform is varied by the voltage of the modulating waveform.
- **FM:** frequency modulation. The frequency of the carrier waveform is varied by the voltage of the modulating waveform.
- **PM:** phase modulation. The phase of the carrier waveform is varied by the voltage of the modulating waveform.

Return Format

The query returns AM, FM, or PM.

Example

```
:SOURce:MOD:TYPe AM /*Sets the modulation type to AM*/
:SOURce:MOD:TYPe? /*The query returns AM.*/
```

3.25.11 :SOURce:MOD:AM:DEPT**Syntax**

```
:SOURce:MOD:AM:DEPT <depth>
```

```
:SOURce:MOD:AM:DEPT?
```

Description

Sets or queries the modulation depth of AM.

Parameter

Name	Type	Range	Default
<depth>	Real	0% to 120%	100%

Remarks

Modulation depth is a percentage that represents the amplitude variation.

- At 0% depth, the amplitude is one-half of the carrier's amplitude setting.
- At 100% depth, the amplitude is identical to the carrier's amplitude setting.

- At greater than 100% depth, envelop distortion will occur which must be avoided in actual circuits. The instrument will not exceed 2.5 Vpp on the output (into a 50 Ω load).

Return Format

The query returns the AM modulation depth in scientific notation. For example, the query might return 5.000000000E+01, indicating that the modulation depth is 50%.

Example

```
:SOURce:MOD:AM:DEPTh 50 /*Sets the modulation depth of AM to 50%.*/
:SOURce:MOD:AM:DEPTh? /*The query returns 5.000000000E+01.*/
```

3.25.12 :SOURce:MOD:AM:INTernal:FREQuency

Syntax

```
:SOURce:MOD:AM:INTernal:FREQuency <freq>
:SOURce:MOD:AM:INTernal:FREQuency?
```

Description

Sets or queries the modulation frequency of AM.

Parameter

Name	Type	Range	Default
<freq>	Real	2 mHz to 1 MHz	100 Hz

Remarks

N/A

Return Format

The query returns the AM modulation frequency in scientific notation. For example, the query might return 1.500000000E+02, indicating that the modulation frequency is 150 Hz.

Example

```
:SOURce:MOD:AM:INTernal:FREQuency 150 /*Sets the modulation
frequency of AM to 150 Hz.*/
:SOURce:MOD:AM:INTernal:FREQuency? /*The query returns 1.500000000E
+02.*/
```

3.25.13 :SOURce:MOD:AM:INTernal:FUNction

Syntax

```
:SOURce:MOD:AM:INTernal:FUNction <function>
```

`:SOURce:MOD:AM:INTernal:FUNction?`

Description

Sets or queries the modulation waveform of AM.

Parameter

Name	Type	Range	Default
<function>	Discrete	{SINusoid SQUare TRlangle UPRamp DNRamp NOISe}	SINusoid

Remarks

- **SINusoid:** sine wave.
- **SQUare:** square with 50% duty cycle.
- **TRlangle:** triangle with 50% symmetry
- **UPRamp:** UpRamp with 100% symmetry.
- **DNRamp:** DnRamp with 0% symmetry.
- **NOISe:** noise-white gaussian noise.

Return Format

The query returns SIN, SQU, TRI, UPR, DNR, and NOIS.

Example

```
:SOURce:MOD:AM:INTernal:FUNction SQUare /*Sets the modulation
waveform of AM to Square.*/
:SOURce:MOD:AM:INTernal:FUNction? /*The query returns SQU.*/
```

3.25.14 :SOURce:MOD:FM:DEVIation

Syntax

`:SOURce:MOD:FM:DEVIation <deviation>`

`:SOURce:MOD:FM:DEVIation?`

Description

Sets or queries the frequency deviation of FM.

Parameter

Name	Type	Range	Default
<deviation>	Real	2 mHz to the current carrier frequency	1 kHz

Remarks

- Frequency deviation represents the peak variation in frequency of the modulated waveform from the carrier frequency.
- The carrier frequency plus the deviation must be less than or equal to the selected carrier's maximum frequency plus 1 kHz.
- The ranges of different carrier frequencies (*:SOURce:FREQuency*) vary in different modulation modes.

Return Format

The query returns the frequency deviation in scientific notation. For example, the query might return 1.0000000000E+02, indicating that the frequency deviation is 100 Hz.

Example

```
:SOURce:MOD:FM:DEVIation 100 /*Sets the frequency deviation of FM
to 100 Hz.*/
:SOURce:MOD:FM:DEVIation? /*The query returns 1.0000000000E+02.*/
```

3.25.15 :SOURce:MOD:FM:INTernal:FREQuency**Syntax**

```
:SOURce:MOD:FM:INTernal:FREQuency <freq>
```

```
:SOURce:MOD:FM:INTernal:FREQuency?
```

Description

Sets or queries the modulation frequency of FM.

Parameter

Name	Type	Range	Default
<freq>	Real	2 mHz to 1 MHz	100 Hz

Remarks

N/A

Return Format

The query returns the FM modulation frequency in scientific notation. For example, the query might return 1.5000000000E+02, indicating that the modulation frequency is 150 Hz.

Example

```
:SOURce:MOD:FM:INTernal:FREQuency 150 /*Sets the modulation
frequency of FM to 150 Hz.*/
:SOURce:MOD:FM:INTernal:FREQuency? /*The query returns 1.5000000000E
+02.*/
```

3.25.16 :SOURce:MOD:FM:INTernal:FUNCTion**Syntax**

```
:SOURce:MOD:FM:INTernal:FUNCTion <function>
```

```
:SOURce:MOD:FM:INTernal:FUNCTion?
```

Description

Sets or queries the modulation waveform of FM.

Parameter

Name	Type	Range	Default
<function>	Discrete	{SINusoid SQUare TRIangle UPRamp DNRamp NOISe}	SINusoid

Remarks

- **SINusoid:** sine wave.
- **SQUare:** square with 50% duty cycle.
- **TRIangle:** triangle with 50% symmetry
- **UPRamp:** UpRamp with 100% symmetry.
- **DNRamp:** DnRamp with 0% symmetry.
- **NOISe:** noise-white gaussian noise.

Return Format

The query returns SIN, SQU, TRI, UPR, DNR, and NOIS.

Example

```
:SOURce:MOD:FM:INTernal:FUNCTion SQUare /*Sets the modulation
waveform of FM to Square.*/
:SOURce:MOD:FM:INTernal:FUNCTion? /*The query returns SQU.*/
```

3.25.17 :SOURce:MOD:PM:DEVIation**Syntax**

```
:SOURce:MOD:PM:DEVIation <deviation>
```

```
:SOURce:MOD:PM:DEVIation?
```

Description

Sets or queries the phase deviation of PM.

Parameter

Name	Type	Range	Default
<deviation>	Real	0° to 360°	90°

Remarks

Phase deviation represents the peak variation in phase of the modulated waveform from the carrier waveform.

Return Format

The query returns the PM phase deviation in scientific notation. For example, the query might return 5.000000000E+01, indicating that the phase deviation is 50°.

Example

```
:SOURce:MOD:PM:DEVIation 50 /*Sets the phase deviation of PM to
50°.* /
:SOURce:MOD:PM:DEVIation? /*The query returns 5.000000000E+01.* /
```

3.25.18 :SOURce:MOD:PM:INTernal:FREQuency

Syntax

```
:SOURce:MOD:PM:INTernal:FREQuency <freq>
```

```
:SOURce:MOD:PM:INTernal:FREQuency?
```

Description

Sets or queries the modulation frequency of PM.

Parameter

Name	Type	Range	Default
<freq>	Real	2 mHz to 1 MHz	100 Hz

Remarks

N/A

Return Format

The query returns the PM modulation frequency in scientific notation. For example, the query might return 1.500000000E+02, indicating that the modulation frequency is 150 Hz.

Example

```
:SOURce:MOD:PM:INTernal:FREQuency 150 /*Sets the modulation
frequency of PM to 150 Hz.*/
:SOURce:MOD:PM:INTernal:FREQuency? /*The query returns 1.5000000000E
+02.*/
```

3.25.19 :SOURce:MOD:PM:INTernal:FUNction**Syntax**

```
:SOURce:MOD:PM:INTernal:FUNction <function>
```

```
:SOURce:MOD:PM:INTernal:FUNction?
```

Description

Sets or queries the modulation waveform of PM.

Parameter

Name	Type	Range	Default
<function>	Discrete	{SINusoid SQUare TRIangle UPRamp DNRamp NOISe}	SINusoid

Remarks

- **SINusoid:** sine wave.
- **SQUare:** square with 50% duty cycle.
- **TRIangle:** triangle with 50% symmetry
- **UPRamp:** UpRamp with 100% symmetry.
- **DNRamp:** DnRamp with 0% symmetry.
- **NOISe:** noise-white gaussian noise.

Return Format

The query returns SIN, SQU, TRI, UPR, DNR, and NOIS.

Example

```
:SOURce:MOD:PM:INTernal:FUNction SQUare /*Sets the modulation
waveform of PM to Square.*/
:SOURce:MOD:PM:INTernal:FUNction? /*The query returns SQU.*/
```

3.26 :TIMebase Commands

:TIMebase commands are used to set the horizontal system. For example, you can enable the Zoom mode or set the horizontal time base mode.

Horizontal Time Base Mode

- **YT Mode:** By default, this series oscilloscope uses the YT mode for waveform display window. In YT mode, Y-axis indicates the Voltage and X-axis indicates the Time.
- **XY Mode:** In XY mode, both the X-axis and Y-axis indicate voltage. The XY mode converts the oscilloscope from a "Voltage-Time" display to a "Voltage-Voltage" display using two input channels. The XY mode can be used to measure the phase deviation occurred when the signal under test passes through a circuit network.
- **Roll Mode:** The roll mode causes the waveform to move across the screen from right to left. It allows you to view the acquired data without waiting for a complete acquisition. The Roll mode is automatically enabled when the horizontal time base is set to 50 ms/div or slower.



TIP

- If the Zoom mode is currently turned on, enabling the roll mode automatically turns off the Zoom mode.
- The following functions are not available when the roll mode is enabled: To Adjust the Horizontal Position (available when the oscilloscope run state is STOP), Zoom Mode (Delayed Sweep), Triggering the Oscilloscope, Protocol Decoding, Pass/Fail Test, Waveform Recording and Playing, Persistence Time, XY Mode, and Average.

3.26.1 :TIMEbase:DELay:ENABle

Syntax

:TIMEbase:DELay:ENABle <bool>

:TIMEbase:DELay:ENABle?

Description

Turns on or off the delayed sweep; or queries the on/off status of the delayed sweep.

Parameter

Name	Type	Range	Default
<bool>	Bool	{{1 ON}} {{0 OFF}}	0 OFF

Remarks

Delayed sweep can be used to enlarge a length of waveform horizontally to view waveform details.

Return Format

The query returns 1 or 0.

Example

```
:TIMebase:DELAy:ENABle ON /*Enables the delayed sweep.*/
:TIMebase:DELAy:ENABle? /*The query returns 1.*/
```

3.26.2 :TIMebase:DELAy:OFFSet**Syntax**

```
:TIMebase:DELAy:OFFSet <offset>
```

```
:TIMebase:DELAy:OFFSet?
```

Description

Sets or queries the offset of the delayed time base.

Parameter

Name	Type	Range	Default
<offset>	Real	-(LeftTime - DelayRange/2) to (RightTime - DelayRange/2)	0

Remarks

LeftTime = 5 × MainScale - MainOffset

RightTime = 5 × MainScale + MainOffset

DelayRange = 10 × DelayScale

Wherein, MainScale indicates the current main time base scale, MainOffset indicates the current main time base offset, and

DelayScale indicates the current delay time base scale.

Return Format

The query returns the offset of the delayed time base in scientific notation.

Example

```
:TIMebase:DELAy:OFFSet 0.000002 /*Sets the offset of the delayed
time base to 2 μs.*/
:TIMebase:DELAy:OFFSet? /*The query returns 2.000000E-6.*/
```

3.26.3 :TIMEbase:DElay:SCALE

Syntax

```
:TIMEbase:DElay:SCALE <scale>
```

```
:TIMEbase:DElay:SCALE?
```

Description

Sets or queries the scale of the delayed time base. The default unit is s/div.

Parameter

Name	Type	Range	Default
<scale>	Real	Refer to <i>Remarks</i>	-

Remarks

- The maximum value of the parameter <scale> is the current scale of the main time base.
- The delayed time base scale can only be the maximum value or the values acquired by reducing the maximum value at 1-2-5 step. If the minimum value calculated according to the above formula is not one of the settable values, take the minimum settable value that is greater than the minimum value calculated.
- The default value of the delayed time base scale is determined by the scale in Main mode and its value is the next scale value in Main mode.

Return Format

The query returns the scale of the delayed time base in scientific notation.

Example

```
:TIMEbase:DElay:SCALE 0.00000005 /*Sets the scale of the delayed
time base to 50 ns/div.*/
:TIMEbase:DElay:SCALE? /*The query returns 5.000000E-8.*/
```

3.26.4 :TIMEbase[:MAIN][:OFFSet]

Syntax

```
:TIMEbase[:MAIN][:OFFSet] <offset>
```

```
:TIMEbase[:MAIN][:OFFSet]?
```

Description

Sets or queries the offset of the main time base. The default unit is s.

Parameter

Name	Type	Range	Default
<offset>	Real	Refer to <i>Remarks</i>	0

Remarks

- In RUN state, the offset range of the main time base is as follows:
 - MainLeftTime = -5 x MainScale
 - When MainScale ≤ 10 ms, MainRightTime = 1 s
 - When 10 ms < MainScale < 10 s, MainRightTime = 100 x MainScale
 - When MainScale < 200 s and MainScale ≥ 10 s, MainRightTime = 1 ks
 - When MainScale ≥ 200s, MainRightTime = 5 x MainScale

MainRightTime indicates the maximum offset value of the main time base;
MainLeftTime indicates the minimum offset value of the main time base;
MainScale is the current scale of the main time base.
- In Stop state, the offset range of the main time base is the same as that of the memory sampling.

Return Format

The query returns the offset of the main time base in scientific notation.

Example

```
:TIMebase:MAIN:OFFSet 0.0002 /*Sets the offset of the main time
base to 200 μs.*/
:TIMebase:MAIN:OFFSet? /*The query returns 2.000000E-4.*/
```

3.26.5 :TIMebase[:MAIN]:SCALE**Syntax**

```
:TIMebase[:MAIN]:SCALE <scale>
```

```
:TIMebase[:MAIN]:SCALE?
```

Description

Sets or queries the main time base scale.

Parameter

Name	Type	Range	Default
<scale>	Real	Refer to <i>Remarks</i>	5 ns/div

Remarks

The range of <scale> is related to the bandwidth of the oscilloscope and the horizontal time base mode.

Return Format

The query returns the main time base scale in scientific notation.

Example

```
:TIMebase:MAIN:SCALE 0.0002 /*Sets the main time base scale to
200 μs/div.*/
:TIMebase:MAIN:SCALE? /*The query returns 2.000000E-4.*/
```

3.26.6 :TIMebase:MODE

Syntax

```
:TIMebase:MODE <mode>
```

```
:TIMebase:MODE?
```

Description

Sets or queries the horizontal time base mode.

Parameter

Name	Type	Range	Default
<mode>	Discrete	{MAIN XY ROLL}	MAIN

Remarks

- **MAIN:** indicates the current time base mode. When you send the `:TIMebase:MODE MAIN` command, the time base is set to YT mode.
- **XY:** indicates the XY mode. After performing the command `:TIMebase:MODE XY` to configure the XY mode, you can send the query command `:TIMebase:MODE?` to query the time base mode. The query returns MAIN.
- **ROLL:** roll mode.

For different time base modes, refer to [Horizontal Time Base Mode](#).

Return Format

The query returns MAIN or ROLL.

Example

```
:TIMEbase:MODE ROLL /*Sets the horizontal time base mode to
ROLL.*/
:TIMEbase:MODE? /*The query returns ROLL.*/
```

3.26.7 :TIMEbase:HREFerence:MODE**Syntax**

```
:TIMEbase:HREFerence:MODE <href>
```

```
:TIMEbase:HREFerence:MODE?
```

Description

Sets or queries the horizontal reference mode.

Parameter

Name	Type	Range	Default
<href>	Discrete	{CENTer LB RB TRIG USER}	CENTer

Remarks

- **CENTer:** when the horizontal time base is modified, the waveform displayed will be expanded or compressed horizontally relative to the screen center.
- **LB:** when the horizontal time base is modified, the waveform displayed will be expanded or compressed relative to the left border of the screen.
- **RB:** when the horizontal time base is modified, the waveform displayed will be expanded or compressed relative to the right border of the screen.
- **TRIG:** when the horizontal time base is modified, the waveform displayed will be expanded or compressed horizontally relative to the trigger position.
- **USER:** when the horizontal time base is modified, the waveform displayed will be expanded or compressed horizontally relative to the user-defined reference position.

Return Format

The query returns CENT, LB, RB, TRIG, or USER.

Example

```
:TIMEbase:HREFerence:MODE TRIG /*Sets the horizontal
reference mode to trigger position.*/
:TIMEbase:HREFerence:MODE? /*The query returns TRIG.*/
```

3.26.8 :TIMebase:HREFerence:POSition

Syntax

```
:TIMebase:HREFerence:POSition <pos>
```

```
:TIMebase:HREFerence:POSition?
```

Description

Sets or queries the user-defined reference position when the waveforms are expanded or compressed horizontally.

Parameter

Name	Type	Range	Default
<pos>	Integer	-500 to 500	0

Remarks

N/A

Return Format

The query returns an integer ranging from -500 to 500.

Example

```
:TIMebase:HREFerence:POSition 60 /*Sets the user-defined
reference position to 60.*/
:TIMebase:HREFerence:POSition? /*The query returns
60.*/
```

3.26.9 :TIMebase:VERNier

Syntax

```
:TIMebase:VERNier <bool>
```

```
:TIMebase:VERNier?
```

Description

Enables or disables the fine adjustment function of the horizontal scale; or queries the on/off status of the fine adjustment function of the horizontal scale.

Parameter

Name	Type	Range	Default
<bool>	Bool	{{1 ON}} {{0 OFF}}	0 OFF

Remarks

N/A

Return Format

The query returns 1 or 0.

Example

```
:TIMEbase:VERNier ON /*Sets the fine adjustment function
of the horizontal scale to ON.*/
:TIMEbase:VERNier? /*The query returns 1.*/
```

3.26.10 :TIMEbase:HOTKeys**Syntax**

```
:TIMEbase:HOTKeys <action>
```

Description

Sets the running status.

Parameter

Name	Type	Range	Default
<action>	Discrete	{STOP RUN SINGle}	-

Remarks

- **STOP:** stops the measurement.
- **RUN:** runs the measurement.
- **SINGle:** indicates the single trigger measurement.

Return Format

N/A

Example

```
:TIMEbase:HOTKeys RUN /*Sets the operating status to RUN.*/
```

3.26.11 :TIMEbase:ROLL**Syntax**

```
:TIMEbase:ROLL <value>
```

```
:TIMEbase:ROLL?
```

Description

Sets or queries the status of the ROLL mode.

Parameter

Name	Type	Range	Default
<value>	Integer	{0 1}	1

Remarks

- **0**: disables the Auto ROLL mode.
- **1**: enables the Auto ROLL mode. The system enters the ROLL mode automatically when the time base is greater than or equal to 50 ms.

Return Format

The query returns 0 or 1.

Example

```
:TIMEbase:ROLL 0 /*Disables the ROLL mode.*/
:TIMEbase:ROLL? /*The query returns 0.*/
```

3.26.12 :TIMEbase:XY:ENABLE**Syntax**

```
:TIMEbase:XY:ENABle <bool>
:TIMEbase:XY:ENABle?
```

Description

Enables or disables the XY mode; or queries the on/off status of the XY mode.

Parameter

Name	Type	Range	Default
<bool>	Bool	{{1 ON}} {{0 OFF}}	0 OFF

Remarks

N/A

Return Format

The query returns 0 or 1.

Example

```
:TIMEbase:XY:ENABle OFF /*Disables the XY mode.*/
:TIMEbase:XY:ENABle? /*The query returns 0.*/
```

3.26.13 :TIMEbase:XY:X

Syntax

```
:TIMEbase:XY:X <S>
```

```
:TIMEbase:XY:X?
```

Description

Sets or queries the source channel of X coordinate when the horizontal time base mode is XY.

Parameter

Name	Type	Range	Default
<S>	Discrete	{CHANnel1 CHANnel2 CHANnel3 CHANnel4}	CHANnel1

Remarks

N/A

Return Format

The query returns CHAN1, CHAN2, CHAN3, or CHAN4.

Example

```
:TIMEbase:XY:X CHANnel3 /*Sets the source channel of X
coordinate to CHANnel3.*/
:TIMEbase:XY:X? /*The query returns CHAN3.*/
```

3.26.14 :TIMEbase:XY:Y

Syntax

```
:TIMEbase:XY:Y <S>
```

```
:TIMEbase:XY:Y?
```

Description

Sets or queries the channel source of the Y coordinate when the horizontal time base mode is XY.

Parameter

Name	Type	Range	Default
<S>	Discrete	{CHANnel1 CHANnel2 CHANnel3 CHANnel4}	CHANnel2

Remarks

N/A

Return Format

The query returns CHAN1, CHAN2, CHAN3, or CHAN4.

Example

```
:TIMEbase:XY:Y CHANnel3          /*Sets the channel source of the Y
coordinate to CHANnel3.*/
:TIMEbase:XY:Y?                  /*The query returns CHAN3.*/
```

3.26.15 :TIMEbase:XY:Z**Syntax****:TIMEbase:XY:Z** <S>**:TIMEbase:XY:Z?****Description**

Sets or queries Source Z in XY mode.

Parameter

Name	Type	Range	Default
<S>	Discrete	{NONE CHANnel1 CHANnel2 CHANnel3 CHANnel4}	-

Remarks

N/A

Return Format

The query returns NONE, CHAN1, CHAN2, CHAN3, or CHAN4.

Example

```
:TIMEbase:XY:Z CHANnel3          /*Sets Source Z in XY mode to
CHANnel3.*/
:TIMEbase:XY:Z?                  /*The query returns CHAN3.*/
```

3.26.16 :TIMEbase:XY:GRID**Syntax****:TIMEbase:XY:GRID** <grid>**:TIMEbase:XY:GRID?****Description**

Sets or queries the grid type of the XY display.

Parameter

Name	Type	Range	Default
<grid>	Discrete	{FULL HALF NONE}	FULL

Remarks

- **FULL:** turns the background grid and coordinates on.
- **HALF:** turns the background grid off and turns the coordinate on.
- **NONE:** turns the background grid and coordinate off.

Return Format

The query returns FULL, HALF, or NONE.

Example

```
:TIMebase:XY: GRID NONE /*Sets the grid type of the XY display.*/
:TIMebase:XY: GRID? /*The query returns NONE.*/
```

3.27 :TRIGger Commands

The **:TRIGger** commands are used to set the trigger source type, trigger input edge type and trigger delay as well as generating a trigger event.

3.27.1 :TRIGger:MODE

Syntax

```
:TRIGger:MODE <mode>
```

```
:TRIGger:MODE?
```

Description

Sets or queries the trigger type.

Parameter

Name	Type	Range	Default
<mode>	Discrete	{EDGE PULSe SLOPe VIDeo PATtern DURation TIMEout RUNT WINDow DELay SETup NEDGE RS232 IIC SPI CAN LIN}	EDGE

Remarks

Only the DHO900 series supports LIN trigger.

Return Format

The query returns EDGE, PULS, SLOP, VID, PATT, DUR, TIM, RUNT, WIND, DEL, SET, NEDG, RS232, IIC, SPI, CAN, LIN.

Example

```
:TRIGger:MODE SLOPe /*Selects the Slope trigger.*/
:TRIGger:MODE? /*The query returns SLOP.*/
```

3.27.2 :TRIGger:COUPling**Syntax**

```
:TRIGger:COUPling <couple>
```

```
:TRIGger:COUPling?
```

Description

Selects or queries the trigger coupling type.

Parameter

Name	Type	Range	Default
<couple>	Discrete	{AC DC LFReject HFReject}	DC

Remarks

This command is only available for the Edge trigger in which the analog channel is selected as the source.

- **AC:** blocks any DC components to pass the trigger path.
- **DC:** allows DC and AC components to pass the trigger path.
- **LFReject:** blocks the DC components and rejects the low frequency components to pass the trigger path.
- **HFReject:** rejects the high frequency components to pass the trigger path.

Return Format

The query returns AC, DC, LFR, or HFR.

Example

```
:TRIGger:COUPling LFReject /*Sets the trigger coupling type to
low frequency rejection.*/
:TRIGger:COUPling? /*The query returns LFR.*/
```

3.27.3 :TRIGger:STATus?

Syntax

```
:TRIGger:STATus?
```

Description

Queries the current trigger status.

Parameter

N/A

Remarks

N/A

Return Format

The query returns TD, WAIT, RUN, AUTO, or STOP.

Example

N/A

3.27.4 :TRIGger:SWEep

Syntax

```
:TRIGger:SWEep <sweep>
```

```
:TRIGger:SWEep?
```

Description

Sets or queries the trigger mode.

Parameter

Name	Type	Range	Default
<sweep>	Discrete	{AUTO NORMal SINGLE}	AUTO

Remarks

- **AUTO:** Auto trigger. The waveforms are displayed no matter whether the trigger conditions are met.
- **NORMal:** Normal trigger. The waveforms are displayed when trigger conditions are met. If the trigger conditions are not met, the oscilloscope displays the original waveforms and waits for another trigger.

- **SINGLE:** Single trigger. The oscilloscope waits for a trigger, displays the waveforms when the trigger conditions are met, and then stops.

Return Format

The query returns AUTO, NORM, or SING.

Example

```
:TRIGger:SWEep NORMal /*Selects the normal trigger mode.*/
:TRIGger:SWEep? /*The query returns NORM.*/
```

3.27.5 :TRIGger:HOLDoff

Syntax

```
:TRIGger:HOLDoff <value>
```

```
:TRIGger:HOLDoff?
```

Description

Sets or queries the trigger holdoff time. The default unit is s.

Parameter

Name	Type	Range	Default
<value>	Real	8 ns to 10 s	8 ns

Remarks

- Trigger holdoff can be used to stably trigger complex waveforms (such as pulse waveform). Holdoff time indicates the time that the oscilloscope waits for re-arming the trigger module. The oscilloscope will not trigger before the holdoff time expires.
- Holdoff time is not available for Video trigger, Timeout trigger, Setup&Hold trigger, Nth Edge trigger, RS232 trigger, I2C trigger, SPI trigger, CAN trigger, LIN trigger.
- Only the DHO900 series supports LIN trigger.

Return Format

The query returns the trigger holdoff time in scientific notation.

Example

```
:TRIGger:HOLDoFF 0.0000002 /*Sets the trigger holdoff time to 200
ns.*/
:TRIGger:HOLDoFF? /*The query returns 2.000000E-7.*/
```

3.27.6 :TRIGger:NREJect**Syntax**

```
:TRIGger:NREJect <bool>
```

```
:TRIGger:NREJect?
```

Description

Turns on or off noise rejection; or queries the on/off status of noise rejection.

Parameter

Name	Type	Range	Default
<bool>	Bool	{{1 ON}}{0 OFF}}	0 OFF

Remarks

- Noise rejection reduces the possibility of the Noise trigger.
- This command is only available when the source is an analog channel or EXT.

Return Format

The query returns 1 or 0.

Example

```
:TRIGger:NREJect ON /*Enables the noise rejection function.*/
:TRIGger:NREJect? /*The query returns 1.*/
```

3.27.7 :TRIGger:POSition?**Syntax**

```
:TRIGger:POSition?
```

Description

Queries the waveform trigger position relative to the corresponding position in the internal memory.

Parameter

N/A

Remarks

N/A

Return Format

The query returns the waveform trigger position relative to the corresponding position in the internal memory in scientific notation.

Example

```
:TRIGger:POSition? /*The query returns 0.000E+00.*/
```

3.27.8 :TRIGger:EDGE

Edge trigger identifies a trigger on the trigger level of the specified edge on the input signal.

3.27.8.1 :TRIGger:EDGE:SOURce

Syntax

```
:TRIGger:EDGE:SOURce <source>
```

```
:TRIGger:EDGE:SOURce?
```

Description

Sets or queries the trigger source of Edge trigger.

Parameter

Name	Type	Range	Default
<source>	Discrete	{D0 D1 D2 D3 D4 D5 D6 D7 D8 D9 D10 D11 D12 D13 D14 D15 CHANnel1 CHANnel2 CHANnel3 CHANnel4 EXT}	CHANnel1

Remarks

Digital channels (D0 to D15) are only supported by the DHO900 series.

EXT is only available for DHO812 and DHO802.

Return Format

The query returns D0, D1, D2, D3, D4, D5, D6, D7, D8, D9, D10, D11, D12, D13, D14, D15, CHAN1, CHAN2, CHAN3, CHAN4, or EXT.

Example

```
:TRIGger:EDGE:SOURce CHANnel1 /*Sets the trigger source to
CHANnel1.*/
:TRIGger:EDGE:SOURce? /*The query returns CHAN1.*/
```

3.27.8.2 :TRIGger:EDGE:SLOPe

Syntax

```
:TRIGger:EDGE:SLOPe <slope>
```

```
:TRIGger:EDGE:SLOPe?
```

Description

Sets or queries the edge type of Edge trigger.

Parameter

Name	Type	Range	Default
<slope>	Discrete	{POSitive NEGative RFALL}	POSitive

Remarks

- **POSitive:** indicates the rising edge.
- **NEGative:** indicates the falling edge.
- **RFALL:** indicates the rising or falling edge.

Return Format

The query returns POS, NEG, or RFAL.

Example

```
:TRIGger:EDGE:SLOPe NEGative /*Sets the edge type to NEGative.*/
:TRIGger:EDGE:SLOPe? /*The query returns NEG.*/
```

3.27.8.3 :TRIGger:EDGE:LEVel

Syntax

```
:TRIGger:EDGE:LEVel <level>
```

```
:TRIGger:EDGE:LEVel?
```

Description

Sets or queries the trigger level of Edge trigger. The unit is the same as that of current amplitude of the selected source.

Parameter

Name	Type	Range	Default
<level>	Real	Analog channel: (-4.5 x VerticalScale - Offset) to (4.5 x VerticalScale - Offset)	0 V

Name	Type	Range	Default
		Digital channel: -20 V to 20 V	

Remarks

For VerticalScale, refer to the `:CHANnel<n>:SCALE` command. For OFFSet, refer to the `:CHANnel<n>:OFFSet` command.

Only when the selected source is an analog channel, a digital channel, or an external trigger, can this setting command be valid.

Return Format

The query returns the trigger level in scientific notation.

Example

```
:TRIGger:EDGE:LEVel 0.16 /*Sets the trigger level to 160 mV.*/
:TRIGger:EDGE:LEVel? /*The query returns 1.600000E-1.*/
```

3.27.9 :TRIGger:PULSe

Pulse width triggering sets the oscilloscope to trigger on the positive or negative pulse of a specified width. In this mode, the oscilloscope will trigger when the pulse width of the input signal satisfies the specified pulse width condition.

In this oscilloscope, positive pulse width is defined as the time difference between the two crossing points of the trigger level and positive pulse; negative pulse width is defined as the time difference between the two crossing points of the trigger level and negative pulse, as shown in the figure below.

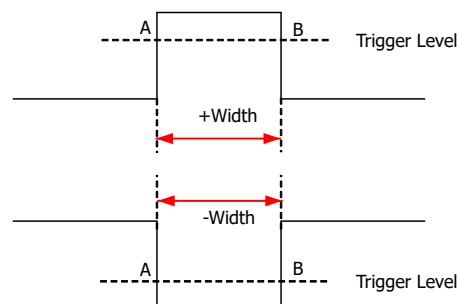

3.27.9.1 :TRIGger:PULSe:SOURce

Syntax

```
:TRIGger:PULSe:SOURce <source>
```

```
:TRIGger:PULSe:SOURce?
```

Description

Sets or queries the trigger source of Pulse trigger.

Parameter

Name	Type	Range	Default
<source>	Discrete	{D0 D1 D2 D3 D4 D5 D6 D7 D8 D9 D10 D11 D12 D13 D14 D15 CHANnel1 CHANnel2 CHANnel3 CHANnel4}	CHANnel1

Remarks

Digital channels (D0 to D15) are only supported by the DHO900 series.

Return Format

The query returns D0, D1, D2, D3, D4, D5, D6, D7, D8, D9, D10, D11, D12, D13, D14, D15, CHAN1, CHAN2, CHAN3, or CHAN4.

Example

```
:TRIGger:PULSe:SOURce CHANnel1 /*Sets the trigger source of Pulse
trigger to CHANnel1.*/
:TRIGger:PULSe:SOURce? /*The query returns CHAN1.*/
```

3.27.9.2 :TRIGger:PULSe:POLarity**Syntax**

```
:TRIGger:PULSe:POLarity <polarity>
```

```
:TRIGger:PULSe:POLarity?
```

Description

Sets or queries the polarity of Pulse trigger.

Parameter

Name	Type	Range	Default
<polarity>	Discrete	{POSitive NEGative}	POSitive

Remarks

N/A

Return Format

The query returns POS or NEG.

Example

```
:TRIGger:PULSe:POLarity NEGative /*Sets the polarity of Pulse
trigger to NEGative.*/
:TRIGger:PULSe:POLarity? /*The query returns NEG.*/
```

3.27.9.3 :TRIGger:PULSe:WHEN

Syntax

```
:TRIGger:PULSe:WHEN <when>
```

```
:TRIGger:PULSe:WHEN?
```

Description

Sets or queries the trigger condition of Pulse trigger.

Parameter

Name	Type	Range	Default
<when>	Discrete	{GREater LESS GLESS}	GREater

Remarks

- **GREater:** triggers when the positive/negative pulse width of the input signal is greater than the specified pulse width.
- **LESS:** triggers when the positive/negative pulse width of the input signal is smaller than the specified pulse width.
- **GLESS:** triggers when the positive/negative pulse is greater than than the specified lower limit of pulse width and smaller than the specified upper limit of pulse width.

Return Format

The query returns GRE, LESS, or GLE.

Example

```
:TRIGger:PULSe:WHEN LESS /*Sets the trigger condition to LESS.*/
:TRIGger:PULSe:WHEN? /*The query returns LESS.*/
```

3.27.9.4 :TRIGger:PULSe:UWIDth

Syntax

```
:TRIGger:PULSe:UWIDth <width>
```

```
:TRIGger:PULSe:UWIDth?
```

Description

Sets or queries the pulse upper limit of the Pulse trigger. The default unit is s.

Parameter

Name	Type	Range	Default
<width>	Real	Pulse lower limit to 10 s	2 μ s

Remarks

This command is only available when the trigger condition is set to LESS or GLEs. To set or query the trigger condition of the Pulse trigger, send the `:TRIGger:PULSe:WHEN` command.

When the trigger condition is set to GLEs, if the set pulse upper limit value is smaller than the lower limit, the lower limit will be automatically changed. You can send the `:TRIGger:PULSe:LWIDth` command to set or query the pulse lower limit value of the Pulse trigger.

Return Format

The query returns the pulse upper limit in scientific notation.

Example

```
:TRIGger:PULSe:UWIDth 0.000003 /*Sets the pulse upper limit to 3
 $\mu$ s.*/
:TRIGger:PULSe:UWIDth? /*The query returns 3.000000E-6.*/
```

3.27.9.5 :TRIGger:PULSe:LWIDth**Syntax**

```
:TRIGger:PULSe:LWIDth <width>
```

```
:TRIGger:PULSe:LWIDth?
```

Description

Sets or queries the pulse lower limit of the Pulse trigger. The default unit is s.

Parameter

Name	Type	Range	Default
<width>	Real	1 ns to upper limit	1 μ s

Remarks

This command is only available when the trigger condition is set to GREater or GLEs. To set or query the trigger condition of the Pulse trigger, send the `:TRIGger:PULSe:WHEN` command.

When the trigger condition is set to GLEs, if the set pulse lower limit value is greater than the upper limit, the upper limit will be automatically changed. You can send the `:TRIGger:PULSe:UWIDth` command to set or query the pulse upper limit value of the Pulse trigger.

Return Format

The query returns the pulse lower limit in scientific notation.

Example

```
:TRIGger:PULSe:LWIDth 0.000003 /*Sets the pulse lower limit of
the Pulse trigger to 3 μs.*/
:TRIGger:PULSe:LWIDth? /*The query returns 3.000000E-6.*/
```

3.27.9.6 :TRIGger:PULSe:LEVel**Syntax**

```
:TRIGger:PULSe:LEVel <level>
```

```
:TRIGger:PULSe:LEVel?
```

Description

Sets or queries the trigger level of Pulse trigger. The unit is the same as that of the current amplitude.

Parameter

Name	Type	Range	Default
<level>	Real	Analog channel: (-4.5 x VerticalScale - Offset) to (4.5 x VerticalScale - Offset) Digital channel: -20 V to 20 V	0 V

Remarks

For VerticalScale, refer to the `:CHANnel<n>:SCALE` command. For OFFSet, refer to the `:CHANnel<n>:OFFSet` command.

Return Format

The query returns the trigger level in scientific notation.

Example

```
:TRIGger:PULSe:LEVel 0.16 /*Sets the trigger level to 160 mV.*/
:TRIGger:PULSe:LEVel? /*The query returns 1.600000E-1.*/
```

3.27.10 :TRIGger:SLOPe

Slope triggering sets the oscilloscope to trigger on the positive or negative slope of the specified time. This trigger mode is applicable to ramp and triangle waveforms.

In this oscilloscope, positive slope time is defined as the time difference between the two crossing points of trigger level line A and B with the rising edge; negative slope time is defined as the time difference between the two crossing points of trigger level line A and B with the falling edge. See the figure below.

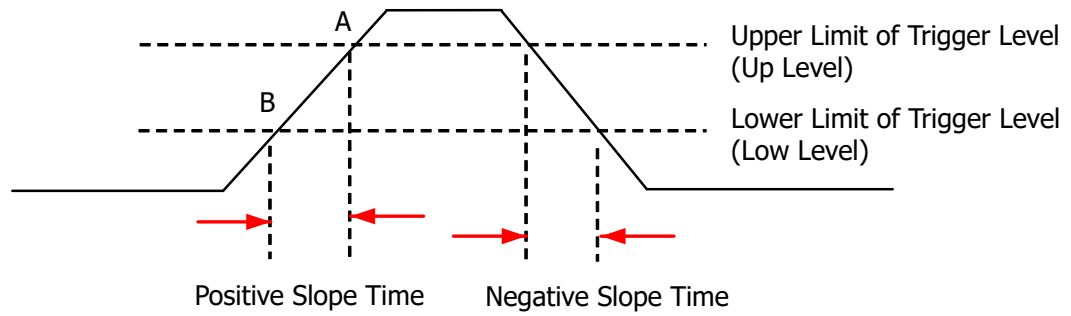

3.27.10.1 :TRIGger:SLOPe:SOURce

Syntax

```
:TRIGger:SLOPe:SOURce <channel>
```

```
:TRIGger:SLOPe:SOURce?
```

Description

Sets or queries the trigger source of Slope trigger.

Parameter

Name	Type	Range	Default
<channel>	Discrete	{CHANnel1 CHANnel2 CHANnel3 CHANnel4}	CHANnel1

Remarks

N/A

Return Format

The query returns CHAN1, CHAN2, CHAN3, or CHAN4.

Example

```
:TRIGger:SLOPe:SOURce CHANnel2 /*Sets the trigger source to  
CHANnel2.*/  
:TRIGger:SLOPe:SOURce? /*The query returns CHAN2.*/
```

3.27.10.2 :TRIGger:SLOPe:POLarity

Syntax

```
:TRIGger:SLOPe:POLarity <polarity>
```

```
:TRIGger:SLOPe:POLarity?
```

Description

Sets or queries the edge type of Slope trigger.

Parameter

Name	Type	Range	Default
<polarity>	Discrete	{POSitive NEGative}	POSitive

Remarks

- **POSitive:** triggers on the rising edge.
- **NEGative:** triggers on the falling edge.

Return Format

The query returns POS or NEG.

Example

```
:TRIGger:SLOPe:POLarity POSitive /*Sets the polarity of Slope
trigger to POSitive.*/
:TRIGger:SLOPe:POLarity? /*The query returns POS.*/
```

3.27.10.3 :TRIGger:SLOPe:WHEN**Syntax**

```
:TRIGger:SLOPe:WHEN <when>
```

```
:TRIGger:SLOPe:WHEN?
```

Description

Sets or queries the trigger condition of Slope trigger.

Parameter

Name	Type	Range	Default
<when>	Discrete	{GREater LESS GLESS}	GREater

Remarks

- **GREater:** the positive slope time of the input signal is greater than the specified time.
- **LESS:** the positive slope time of the input signal is smaller than the specified time.
- **GLESS:** the positive slope time of the input signal is greater than the specified lower time limit and smaller than the specified upper time limit.

Return Format

The query returns GRE, LESS, or GLES.

Example

```
:TRIGger:SLOPe:WHEN LESS /*Sets the trigger condition to LESS.*/
:TRIGger:SLOPe:WHEN? /*The query returns LESS.*/
```

3.27.10.4 :TRIGger:SLOPe:TUPPer**Syntax**

```
:TRIGger:SLOPe:TUPPer <time>
```

```
:TRIGger:SLOPe:TUPPer?
```

Description

Sets or queries the upper time limit value of the Slope trigger. The default unit s.

Parameter

Name	Type	Range	Default
<time>	Real	Lower limit to 10 s	2 μ s

Remarks

This command is only available when the trigger condition is set to LESS or GLES. To set or query the trigger condition of the Slope trigger, send the *:TRIGger:SLOPe:WHEN* command.

When the trigger condition is set to GLEs, if the set upper time limit value is smaller than the lower limit, the lower limit will be automatically changed. You can use the *:TRIGger:SLOPe:TLOWer* command to set or query the lower time limit value of the Slope trigger.

Return Format

The query returns the upper time limit in scientific notation.

Example

```
:TRIGger:SLOPe:TUPPer 0.000003 /*Sets the upper time limit to 3
 $\mu$ s.*/
:TRIGger:SLOPe:TUPPer? /*The query returns 3.000000E-6.*/
```

3.27.10.5 :TRIGger:SLOPe:TLOWer**Syntax**

```
:TRIGger:SLOPe:TLOWer <time>
```

```
:TRIGger:SLOPe:TLOWer?
```

Description

Sets or queries the lower time limit value of the Slope trigger. The default unit is s.

Parameter

Name	Type	Range	Default
<time>	Real	1 ns to upper limit	1 μ s

Remarks

This command is only available when the trigger condition is set to GREater or GLEsS. To set or query the trigger condition of the Slope trigger, send the `:TRIGger:SLOPe:WHEN` command.

When the trigger condition is set to GLEsS, if the set lower time limit value is greater than the upper limit, the upper limit will be automatically changed. You can send the `:TRIGger:SLOPe:TUPPer` command to set or query the upper time limit value of the Slope trigger.

Return Format

The query returns the lower time limit in scientific notation.

Example

```
:TRIGger:SLOPe:TLOWer 0.000000020 /*Sets the lower time limit
to 20 ns.*/
:TRIGger:SLOPe:TLOWer? /*The query returns 2.000000E-8.*/
```

3.27.10.6 :TRIGger:SLOPe:WINDow**Syntax**

```
:TRIGger:SLOPe:WINDow <window>
```

```
:TRIGger:SLOPe:WINDow?
```

Description

Sets or queries the vertical window type of Slope trigger.

Parameter

Name	Type	Range	Default
<window>	Discrete	{TA TB TAB}	TA

Remarks

- **TA:** only adjusts the upper limit of the trigger level.
- **TB:** only adjust the lower limit of the trigger level.

- **TAB:** adjusts the upper and lower limits of the trigger level at the same time.

Return Format

The query returns TA, TB, or TAB.

Example

```
:TRIGger:SLOPe:WINDow TB /*Sets the vertical window type to
TB.*/
:TRIGger:SLOPe:WINDow? /*The query returns TB.*/
```

3.27.10.7 :TRIGger:SLOPe:ALEVel

Syntax

```
:TRIGger:SLOPe:ALEVel <level>
```

```
:TRIGger:SLOPe:ALEVel?
```

Description

Sets or queries the upper limit of the trigger level of Slope trigger. The unit is the same as that of the current amplitude.

Parameter

Name	Type	Range	Default
<level>	Real	Trigger level lower limit to (4.5 x VerticalScale - OFFSet)	0 V

Remarks

For VerticalScale, refer to the `:CHANnel<n>:SCALE` command. For OFFSet, refer to the `:CHANnel<n>:OFFSet` command.

Return Format

The query returns the upper limit of the trigger level in scientific notation.

Example

```
:TRIGger:SLOPe:ALEVel 0.16 /*Sets the upper limit of the trigger
level to 160 mV.*/
:TRIGger:SLOPe:ALEVel? /*The query returns 1.600000E-1.*/
```

3.27.10.8 :TRIGger:SLOPe:BLEVel

Syntax

```
:TRIGger:SLOPe:BLEVel <level>
```

```
:TRIGger:SLOPe:BLEVel?
```

Description

Sets or queries the lower limit of the trigger level of Slope trigger. The unit is the same as that of the current amplitude.

Parameter

Name	Type	Range	Default
<level>	Real	(-4.5 x VerticalScale - OFFSet) to trigger level upper limit	0 V

Remarks

For VerticalScale, refer to the `:CHANnel<n>:SCALE` command. For OFFSet, refer to the `:CHANnel<n>:OFFSet` command.

Return Format

The query returns the lower limit of the trigger level in scientific notation.

Example

```
:TRIGger:SLOPe:BLEVel 0.16 /*Sets the lower limit of the trigger
level to 160 mV.*/
:TRIGger:SLOPe:BLEVel? /*The query returns 1.600000E-1.*/
```

3.27.11 :TRIGger:VIDeo

The video signal can include image information and timing information, which adopts different standards and formats. This series can trigger on the standard video signal field or line of NTSC (National Television Standards Committee), PAL (Phase Alternating Line), or SECAM (Sequential Couleur A Memoire).

3.27.11.1 :TRIGger:VIDeo:SOURce

Syntax

```
:TRIGger:VIDeo:SOURce <source>
```

```
:TRIGger:VIDeo:SOURce?
```

Description

Sets or queries the trigger source of Video trigger.

Parameter

Name	Type	Range	Default
<source>	Discrete	{CHANnel1 CHANnel2 CHANnel3 CHANnel4}	CHANnel1

Remarks

N/A

Return Format

The query returns CHAN1, CHAN2, CHAN3, or CHAN4.

Example

```
:TRIGger:VIDeo:SOURce CHANnel2 /*Sets the trigger source to
CHANnel2.*/
:TRIGger:VIDeo:SOURce? /*The query returns CHAN2.*/
```

3.27.11.2 :TRIGger:VIDeo:POLarity**Syntax**

```
:TRIGger:VIDeo:POLarity <polarity>
```

```
:TRIGger:VIDeo:POLarity?
```

Description

Sets or queries the video polarity of Video trigger.

Parameter

Name	Type	Range	Default
<polarity>	Discrete	{POSitive NEGative}	POSitive

Remarks

N/A

Return Format

The query returns POS or NEG.

Example

```
:TRIGger:VIDeo:POLarity NEGative /*Sets the video polarity to
NEGative.*/
:TRIGger:VIDeo:POLarity? /*The query returns NEG.*/
```

3.27.11.3 :TRIGger:VIDeo:MODE**Syntax**

```
:TRIGger:VIDeo:MODE <mode>
```

```
:TRIGger:VIDeo:MODE?
```

Description

Sets or queries the sync type of Video trigger.

Parameter

Name	Type	Range	Default
<mode>	Discrete	{ODDField EVENfield LINE ALINes}	ALINes

Remarks

- **ODDField:** indicates the odd field. The oscilloscope triggers on the rising edge of the first ramp waveform in the odd field. It is available when the video standard is NTSC, PAL/SECAM, or 1080i.
- **EVENfield:** indicates the even field. The oscilloscope triggers on the rising edge of the first ramp waveform in the even field. It is available when the video standard is NTSC, PAL/SECAM, or 1080i.
- **LINE:** for NTSC and PAL/SECAM video standards, the oscilloscope triggers on the specified line in the odd or even field. For 480p, 576p, 720p, 480p and 1080i video standards, the oscilloscope triggers on the specified line.
- **ALINes:** triggers on all the horizontal sync pulses.

Return Format

The query returns ODDF, EVEN, LINE, or ALIN.

Example

```
:TRIGger:VIDeo:MODE ODDField /*Sets the sync type to ODDField.*/
:TRIGger:VIDeo:MODE? /*The query returns ODDF.*/
```

3.27.11.4 :TRIGger:VIDeo:LINE**Syntax**

```
:TRIGger:VIDeo:LINE <line>
```

```
:TRIGger:VIDeo:LINE?
```

Description

Sets or queries the line number when the sync type of Video trigger is set to Line.

Parameter

Name	Type	Range	Default
<line>	Integer	Refer to <i>Remarks</i>	1

Remarks

- **PAL/SECAM:** 1 to 625
- **NTSC:** 1 to 525
- **480P:** 1 to 525
- **576P:** 1 to 625
- **720P60:** 1 to 750
- **720P50:** 1 to 750
- **720P30:** 1 to 750
- **720P25:** 1 to 750
- **720P24:** 1 to 750
- **1080P60:** 1 to 1125
- **1080P50:** 1 to 1125
- **1080P30:** 1 to 1125
- **1080P25:** 1 to 1125
- **1080P24:** 1 to 1125
- **1080I60:** 1 to 1125
- **1080I50:** 1 to 1125

Return Format

The query returns an integer.

Example

```
:TRIGger:VIDeo:LINE 100 /*Sets the line number to 100.*/
:TRIGger:VIDeo:LINE? /*The query returns 100.*/
```

3.27.11.5 :TRIGger:VIDeo:STANdard**Syntax**

```
:TRIGger:VIDeo:STANdard <standard>
:TRIGger:VIDeo:STANdard?
```

Description

Sets or queries the video standard of Video trigger.

Parameter

Name	Type	Range	Default
<standard>	Discrete	{PALSecam NTSC 480P 576P 720P60 720P50 720P30 720P25 720P24 1080P60 1080P50 1080P30 1080P25 1080P24 1080I60 1080I50}	NTSC

Remarks

Video Standard	Frame Frequency (Frame)	Sweep Function	TV Scan Line
PALSecam	25	Interlaced Scan	625
NTSC	30	Interlaced Scan	525
480P	60	Progressive Scan	525
576P	50	Progressive Scan	625
720P60	60	Progressive Scan	750
720P50	50	Progressive Scan	750
720P30	30	Progressive Scan	750
720P25	25	Progressive Scan	750
720P24	24	Progressive Scan	750
1080P60	60	Progressive Scan	1125
1080P50	50	Progressive Scan	1125
1080P30	30	Progressive Scan	1125
1080P25	25	Progressive Scan	1125
1080P24	24	Progressive Scan	1125
1080I60	60	Interlaced Scan	1125
1080I50	50	Interlaced Scan	1125

Return Format

The query returns PALS, NTSC, 480P, 576P, 720P60, 720P50, 720P30, 720P25, 720P24, 1080P60, 1080P50, 1080P30, 1080P25, 1080P24, 1080I60, or 1080I50.

Example

```
:TRIGger:VIDeo:STANdard NTSC /*Sets the video standard to
NTSC.*/
:TRIGger:VIDeo:STANdard? /*The query returns NTSC.*/
```

3.27.11.6 :TRIGger:VIDeo:LEVel**Syntax**

```
:TRIGger:VIDeo:LEVel <level>
```

```
:TRIGger:VIDeo:LEVel?
```

Description

Sets or queries the trigger level of Video trigger. The unit is the same as that of the current amplitude.

Parameter

Name	Type	Range	Default
<level>	Real	(-4.5 x VerticalScale - Offset) to (4.5 x VerticalScale - Offset)	0 V

Remarks

For VerticalScale, refer to the `:CHANnel<n>:SCALE` command. For Offset, refer to the `:CHANnel<n>:OFFSET` command.

Return Format

The query returns the trigger level in scientific notation.

Example

```
:TRIGger:VIDeo:LEVel 0.16 /*Sets the trigger level to 160 mV.*/
:TRIGger:VIDeo:LEVel? /*The query returns 1.600000E-1.*/
```

3.27.12 :TRIGger:PATtern

The pattern trigger identifies a trigger condition by looking for a specified pattern. This pattern is a logical "AND" combination of channels. Each channel can be set to H (high), L (low), or X (don't care). A rising or falling edge (you can only specify a single edge) can be specified for one channel included in the pattern. When an edge is specified, the oscilloscope will trigger at the edge specified if the pattern set for the other channels are true (namely the actual pattern of the channel is the same as the preset pattern). If no edge is specified, the oscilloscope will trigger on the last edge that makes the pattern true. If all the channels in the pattern are set to "X", the oscilloscope will not trigger.

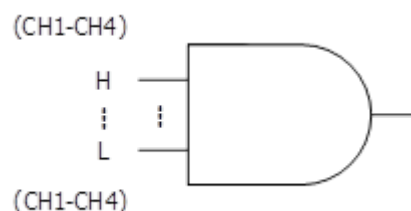
**3.27.12.1 :TRIGger:PATtern:PATtern****Syntax**

```
:TRIGger:PATtern:PATtern <pch1>[,<pch2>[,<pch3>[,<pch4>]]]
```

:TRIGger:PATtern:PATtern?

Description

Sets or queries the channel pattern of Pattern trigger.

Parameter

Name	Type	Range	Default
<pch1>	Discrete	{H L X R F}	X
<pch2>	Discrete	{H L X R F}	X
<pch3>	Discrete	{H L X R F}	X
<pch4>	Discrete	{H L X R F}	X

Remarks

- The parameter "<pch1> to <pch4>" sets the patterns of the analog channels "CHANnel1 to CHANnel4".
- In the parameter range, H indicates high level (higher than the threshold level of the channel), L indicates low level (lower than the threshold level of the channel), and X indicates omitting the channel (This channel is not used as a part of the pattern. When all the channels are set to X, the oscilloscope will not trigger.) R indicates rising edge, and F indicates falling edge.
- In the pattern, you can only specify one edge (rising edge or falling edge). If one edge item is currently defined and then another edge item is defined in another channel in the pattern, then a prompt message "Invalid input" is displayed. Then, the latter defined edge item will be replaced by X.

Return Format

The query returns the currently set pattern of all the channels. The channels are separated by commas.

Example

```
:TRIGger:PATtern:PATtern H,R,L,X /*Sets the patterns of "CHANnel1
to CHANnel4" to H,R,L,X.*/
:TRIGger:PATtern:PATtern? /*The query returns H,R,L,X.*/
```

3.27.12.2 :TRIGger:PATtern:SOURce

Syntax

```
:TRIGger:PATtern:SOURce <source>
```

```
:TRIGger:PATtern:SOURce?
```

Description

Sets or queries the trigger source of Pattern trigger.

Parameter

Name	Type	Range	Default
<source>	Discrete	{CHANnel1 CHANnel2 CHANnel3 CHANnel4 D0 D1 D2 D3 D4 D5 D6 D7 D8 D9 D10 D11 D12 D13 D14 D15}	CHANnel1

Remarks

Digital channels (D0 to D15) are only supported by the DHO900 series.

Return Format

The query returns D0, D1, D2, D3, D4, D5, D6, D7, D8, D9, D10, D11, D12, D13, D14, D15, CHAN1, CHAN2, CHAN3, or CHAN4.

Example

```
:TRIGger:PATtern:SOURce CHANnel2 /*Sets the trigger source to  
CHANnel2.*/  
:TRIGger:PATtern:SOURce? /*The query returns CHAN2.*/
```

3.27.12.3 :TRIGger:PATtern:LEVel

Syntax

```
:TRIGger:PATtern:LEVel <source>,<level>
```

```
:TRIGger:PATtern:LEVel? <source>
```

Description

Sets or queries the trigger level of the specified channel in Pattern trigger. The unit is the same as that of the current amplitude.

Parameter

Name	Type	Range	Default
<source>	Discrete	{CHANnel1 CHANnel2 CHANnel3 CHANnel4 D0 D1 D2	CHANnel1

Name	Type	Range	Default
		D3 D4 D5 D6 D7 D8 D9 D10 D11 D12 D13 D14 D15}	
<level>	Real	Analog channel: (-4.5 x VerticalScale - Offset) to (4.5 x VerticalScale - Offset) Digital channel: -20 V to 20 V	0 V

Remarks

For VerticalScale, refer to the `:CHANnel<n>:SCALE` command. For OFFSet, refer to the `:CHANnel<n>:OFFSet` command.

Return Format

The query returns the trigger level in scientific notation.

Example

```
:TRIGger:PATtern:LEVel CHANnel2,0.16 /*Sets the trigger level of
CHANnel2 to 160 mV.*/
:TRIGger:PATtern:LEVel? CHANnel2 /*The query returns
1.600000E-1.*/
```

3.27.13 :TRIGger:DURation

In Duration trigger, the oscilloscope identifies a trigger condition by searching for the duration of a specified pattern. This pattern is a logical "AND" combination of the channels. Each channel can be set to 1 (high), 0 (low), or X (don't care). The instrument triggers when the duration (ΔT) of this pattern meets the preset time, as shown in the figure below.

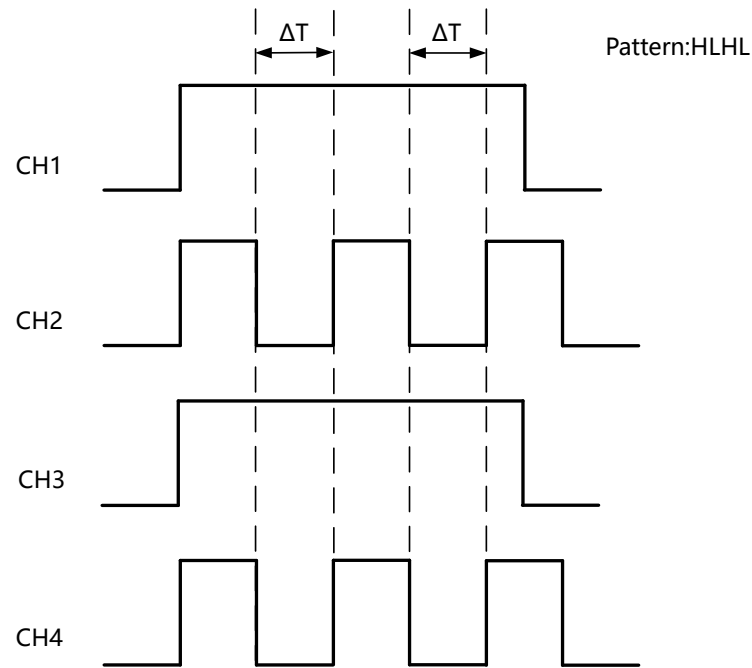

3.27.13.1 :TRIGger:DURation:SOURce

Syntax

```
:TRIGger:DURation:SOURce <source>
```

```
:TRIGger:DURation:SOURce?
```

Description

Sets or queries the trigger source of Duration trigger.

Parameter

Name	Type	Range	Default
<source>	Discrete	{CHANnel1 CHANnel2 CHANnel3 CHANnel4 D0 D1 D2 D3 D4 D5 D6 D7 D8 D9 D10 D11 D12 D13 D14 D15}	CHANnel1

Remarks

Digital channels (D0 to D15) are only supported by the DHO900 series.

Return Format

The query returns D0, D1, D2, D3, D4, D5, D6, D7, D8, D9, D10, D11, D12, D13, D14, D15, CHAN1, CHAN2, CHAN3, or CHAN4.

Example

```
:TRIGger:DURation:SOURce CHANnel2 /*Sets the trigger source to
CHANnel2.*/
:TRIGger:DURation:SOURce? /*The query returns CHAN2.*/
```

3.27.13.2 :TRIGger:DURation:TYPE**Syntax**

```
:TRIGger:DURation:TYPE <pch1>[,<pch2>[,<pch3>[,<pch4>]]]
```

```
:TRIGger:DURation:TYPE?
```

Description

Sets or queries the channel pattern of Duration trigger.

Parameter

Name	Type	Range	Default
<pch1>	Discrete	{H L X}	X
<pch2>	Discrete	{H L X}	X
<pch3>	Discrete	{H L X}	X
<pch4>	Discrete	{H L X}	X

Remarks

- The parameter "<pch1> to <pch4>" sets the patterns of the analog channels "CHANnel1 to CHANnel4".
- In the parameter range, H indicates high level (higher than the threshold level of the channel), L indicates low level (lower than the threshold level of the channel), and X indicates omitting the channel (This channel is not used as a part of the pattern. When all the channels are set to X, the oscilloscope will not trigger.)

Return Format

The query returns the currently set pattern of all the channels. The channels are separated by commas.

Example

```
:TRIGger:DURation:TYPE L,X,H,L /*Sets the patterns of "CHANnel1 to
CHANnel4" to L,X,H,L.*/
:TRIGger:DURation:TYPE? /*The query returns L,X,H,L.*/
```

3.27.13.3 :TRIGger:DURation:WHEN

Syntax

```
:TRIGger:DURation:WHEN <when>
```

```
:TRIGger:DURation:WHEN?
```

Description

Sets or queries the trigger condition of Duration trigger.

Parameter

Name	Type	Range	Default
<when>	Discrete	{GREater LESS GLESs UNGLess}	GREater

Remarks

- **GREater:** triggers when the set duration time of the pattern is greater than the preset time.
- **LESS:** triggers when the set duration time of the pattern is smaller than the preset time.
- **GLESs:** triggers when the set duration time of the pattern is smaller than the preset upper time limit and greater than the preset lower time limit.
- **UNGLess:** triggers when the set duration time of the pattern is greater than the preset upper time limit or smaller than the preset lower time limit.

Return Format

The query returns GRE, LESS, GLES, or UNGL.

Example

```
:TRIGger:DURation:WHEN LESS /*Sets the trigger condition to
LESS.*/
:TRIGger:DURation:WHEN? /*The query returns LESS.*/
```

3.27.13.4 :TRIGger:DURation:TUPPer

Syntax

```
:TRIGger:DURation:TUPPer <time>
```

```
:TRIGger:DURation:TUPPer?
```

Description

Sets or queries the upper limit of the duration time of Duration trigger. The default unit is s.

Parameter

Name	Type	Range	Default
<time>	Real	1.01 ns to 10 s	1 μ s

Remarks

This command is only available when the trigger condition is set to LESS, GLEs, or UNGLess. To set or query the trigger condition of the Duration trigger, send the `:TRIGger:DURation:WHEN` command.

When the trigger condition is set to GLEs or UNGLess, if the set upper limit of the duration time value is smaller than the lower limit, the lower limit will be automatically changed. You can send the `:TRIGger:DURation:TLOWer` command to set or query the lower limit of the duration time value of the Duration trigger.

Return Format

The query returns the upper limit of the duration time in scientific notation.

Example

```
:TRIGger:DURation:TUPPer 0.000003 /*Sets the upper limit of the
duration time to 3  $\mu$ s.*/
:TRIGger:DURation:TUPPer? /*The query returns
3.000000E-6.*/
```

3.27.13.5 :TRIGger:DURation:TLOWer**Syntax**

```
:TRIGger:DURation:TLOWer <time>
```

```
:TRIGger:DURation:TLOWer?
```

Description

Sets or queries the lower limit of the duration time of Duration trigger. The default unit is s.

Parameter

Name	Type	Range	Default
<time>	Real	1 ns to 9.9 s	1 μ s

Remarks

This command is only available when the trigger condition is set to GREater, GLESS, or UNGLess. To set or query the trigger condition of the Duration trigger, send the `:TRIGger:DURation:WHEN` command.

When the trigger condition is set to GLESS or UNGLess, if the set lower limit of the duration time value is greater than the upper limit, the upper limit will be automatically changed. You can send the `:TRIGger:DURation:TUPPer` command to set or query the upper limit of the duration time value of the Duration trigger.

Return Format

The query returns the lower limit of the duration time in scientific notation.

Example

```
:TRIGger:DURation:TLOWer 0.000003 /*Sets the lower limit of the
duration time to 3 μs.*/
:TRIGger:DURation:TLOWer? /*The query returns
3.000000E-6.*/
```

3.27.13.6 :TRIGger:DURation:LEVel**Syntax**

```
:TRIGger:DURation:LEVel <source>,<level>
```

```
:TRIGger:DURation:LEVel?<source>
```

Description

Sets or queries the trigger level of the specified channel in Duration trigger. The unit is the same as that of the current amplitude.

Parameter

Name	Type	Range	Default
<source>	Discrete	{D0 D1 D2 D3 D4 D5 D6 D7 D8 D9 D10 D11 D12 D13 D14 D15 CHANnel1 CHANnel2 CHANnel3 CHANnel4}	CHANnel1
<level>	Real	Analog channel: (-4.5 x VerticalScale - Offset) to (4.5 x VerticalScale - Offset) Digital channel: -20 V to 20 V	0 V

Remarks

For VerticalScale, refer to the `:CHANnel<n>:SCALE` command. For OFFSet, refer to the `:CHANnel<n>:OFFSet` command.

Digital channels (D0 to D15) are only supported by the DHO900 series.

Return Format

The query returns the trigger level in scientific notation.

Example

```
:TRIGger:DURation:LEVel CHANnel2,0.16 /*Sets the trigger level of
CHANnel2 to 160 mV.*/
:TRIGger:DURation:LEVel? CHANnel2 /*The query returns
1.600000E-1.*/
```

3.27.14 :TRIGger:TIMEout

In Timeout trigger, the oscilloscope triggers when the time interval (ΔT) (the time from when the rising edge (or falling edge) of the input signal passes through the trigger level to the time from when the neighboring falling edge (or rising edge) passes through the trigger level) is greater than the preset timeout value, as shown in the figure below.

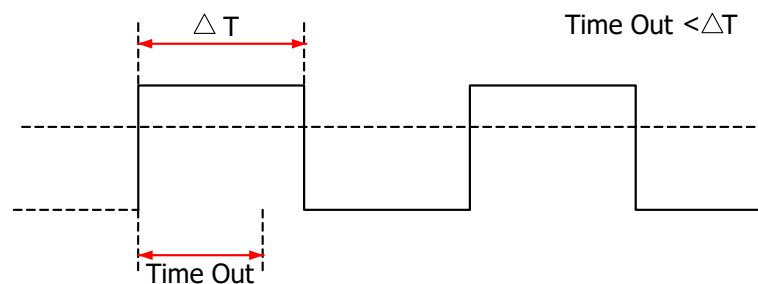

3.27.14.1 :TRIGger:TIMEout:SOURce

Syntax

```
:TRIGger:TIMEout:SOURce <source>
```

```
:TRIGger:TIMEout:SOURce?
```

Description

Sets or queries the trigger source of Timeout trigger.

Parameter

Name	Type	Range	Default
<source>	Discrete	{D0 D1 D2 D3 D4 D5 D6 D7 D8 D9 D10 D11 D12 D13 D14 D15 CHANnel1 CHANnel2 CHANnel3 CHANnel4}	CHANnel1

Remarks

Digital channels (D0 to D15) are only supported by the DHO900 series.

Return Format

The query returns D0, D1, D2, D3, D4, D5, D6, D7, D8, D9, D10, D11, D12, D13, D14, D15, CHAN1, CHAN2, CHAN3, or CHAN4.

Example

```
:TRIGger:TIMEout:SOURce CHANnel2 /*Sets the trigger source to
CHANnel2.*/
:TRIGger:TIMEout:SOURce? /*The query returns CHAN2.*/
```

3.27.14.2 :TRIGger:TIMEout:SLOPe**Syntax**

```
:TRIGger:TIMEout:SLOPe <slope>
```

```
:TRIGger:TIMEout:SLOPe?
```

Description

Sets or queries the edge type of Timeout trigger.

Parameter

Name	Type	Range	Default
<slope>	Discrete	{POSitive NEGative RFALL}	POSitive

Remarks

- **POSitive:** starts timing when the rising edge of the input signal passes through the trigger level.
- **NEGative:** starts timing when the falling edge of the input signal passes through the trigger level.
- **RFALL:** starts timing when any edge of the input signal passes through the trigger level.

Return Format

The query returns POS, NEG, or RFAL.

Example

```
:TRIGger:TIMEout:SLOPe NEGative /*Sets the edge type to
NEGative.*/
:TRIGger:TIMEout:SLOPe? /*The query returns NEG.*/
```

3.27.14.3 :TRIGger:TIMEout:TIME

Syntax

```
:TRIGger:TIMEout:TIME <time>
```

```
:TRIGger:TIMEout:TIME?
```

Description

Sets or queries the timeout value of Timeout trigger. The default unit is s.

Parameter

Name	Type	Range	Default
<time>	Real	1 ns to 10 s	1 μ s

Remarks

N/A

Return Format

The query returns the timeout value in scientific notation.

Example

```
:TRIGger:TIMEout:TIME 0.002 /*Sets the timeout value to 2 ms.*/
:TRIGger:TIMEout:TIME? /*The query returns
2.000000E-3.*/
```

3.27.14.4 :TRIGger:TIMEout:LEVel

Syntax

```
:TRIGger:TIMEout:LEVel <level>
```

```
:TRIGger:TIMEout:LEVel?
```

Description

Sets or queries the trigger level of Timeout trigger. The unit is the same as that of the current amplitude.

Parameter

Name	Type	Range	Default
<level>	Real	Analog channel: (-4.5 x VerticalScale - Offset) to (4.5 x VerticalScale - Offset) Digital channel: -20 V to 20 V	0 V

Remarks

For VerticalScale, refer to the `:CHANnel<n>:SCALE` command. For OFFSET, refer to the `:CHANnel<n>:OFFSET` command.

Return Format

The query returns the trigger level in scientific notation.

Example

```
:TRIGger:TIMEout:LEVel 0.16 /*Sets the trigger level to 160
mV.*/
:TRIGger:TIMEout:LEVel? /*The query returns 1.600000E-1.*/
```

3.27.15 :TRIGger:RUNT

The runt trigger sets the oscilloscope to trigger pulses that cross one trigger level but not another, as shown in the figure below.

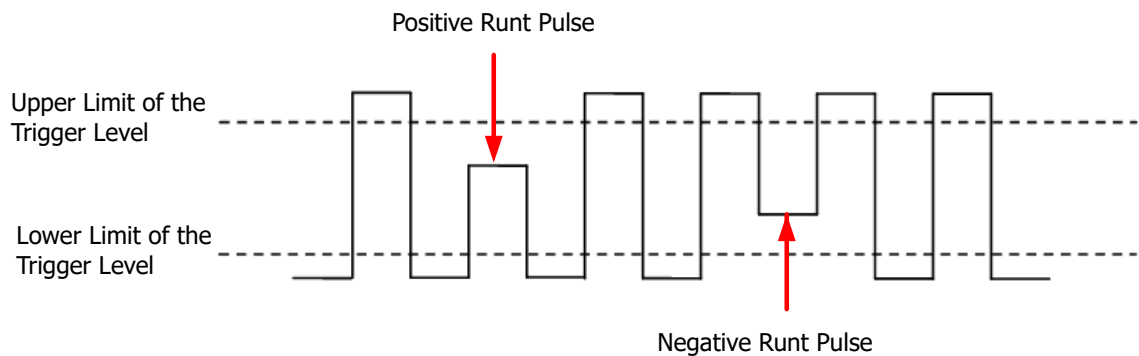
**3.27.15.1 :TRIGger:RUNT:SOURce****Syntax**

```
:TRIGger:RUNT:SOURce <source>
```

```
:TRIGger:RUNT:SOURce?
```

Description

Sets or queries the trigger source of Runt trigger.

Parameter

Name	Type	Range	Default
<source>	Discrete	{CHANnel1 CHANnel2 CHANnel3 CHANnel4}	CHANnel1

Remarks

N/A

Return Format

The query returns CHAN1, CHAN2, CHAN3, or CHAN4.

Example

```
:TRIGger:RUNT:SOURce CHANnel2 /*Sets the trigger source to
CHANnel2.*/
:TRIGger:RUNT:SOURce? /*The query returns CHAN2.*/
```

3.27.15.2 :TRIGger:RUNT:POLarity**Syntax**

```
:TRIGger:RUNT:POLarity <polarity>
```

```
:TRIGger:RUNT:POLarity?
```

Description

Sets or queries the polarity of Runt trigger.

Parameter

Name	Type	Range	Default
<polarity>	Discrete	{POSitive NEGative}	POSitive

Remarks

- **POSitive:** indicates the positive polarity. The oscilloscope triggers on the positive polarity of Runt trigger.
- **NEGative:** indicates the negative polarity. The oscilloscope triggers on the negative polarity of Runt trigger.

Return Format

The query returns POS or NEG.

Example

```
:TRIGger:RUNT:POLarity NEGative /*Sets the polarity of Runt
trigger to NEGative.*/
:TRIGger:RUNT:POLarity? /*The query returns NEG.*/
```

3.27.15.3 :TRIGger:RUNT:WHEN**Syntax**

```
:TRIGger:RUNT:WHEN <when>
```

```
:TRIGger:RUNT:WHEN?
```

Description

Sets or queries the trigger conditions of Runt trigger.

Parameter

Name	Type	Range	Default
<when>	Discrete	{NONE GREater LESS GLESs}	NONE

Remarks

- **NONE:** indicates not setting the trigger condition of Runt trigger.
- **GREater:** triggers when the runt pulse width is greater than the lower limit of pulse width.
- **LESS:** triggers when the runt pulse width is smaller than the upper limit of pulse width.
- **GLESs:** triggers when the runt pulse width is greater than the lower limit and smaller than the upper limit of pulse width.

The lower limit of the pulse width must be smaller than the upper limit.

Return Format

The query returns NONE, GRE, LESS, or GLES.

Example

```
:TRIGger:RUNT:WHEN LESS /*Sets the trigger condition of Runt
trigger to LESS.*/
:TRIGger:RUNT:WHEN? /*The query returns LESS.*/
```

3.27.15.4 :TRIGger:RUNT:WUPPer**Syntax**

```
:TRIGger:RUNT:WUPPer <width>
```

```
:TRIGger:RUNT:WUPPer?
```

Description

Sets or queries the upper limit of the pulse width of Runt trigger. The default unit is s.

Parameter

Name	Type	Range	Default
<width>	Real	1.01 ns to 10 s	2 μ s

Remarks

This command is only available when the trigger condition is set to LESS or GLESSs. To set or query the trigger condition of the Runt trigger, send the `:TRIGger:RUNT:WHEN` command.

When the trigger condition is set to GLESSs, if the set upper limit of the pulse width is smaller than the lower limit, the lower limit will be automatically changed. You can send the `:TRIGger:RUNT:WLOWer` command to set or query the lower limit of the pulse width of Runt trigger.

Return Format

The query returns the pulse upper limit in scientific notation.

Example

```
:TRIGger:RUNT:WUPPer 0.02 /*Sets the upper limit of the pulse
width to 20 ms.*/
:TRIGger:RUNT:WUPPer? /*The query returns 2.000000E-2.*/
```

3.27.15.5 :TRIGger:RUNT:WLOWer**Syntax**

```
:TRIGger:RUNT:WLOWer <width>
```

```
:TRIGger:RUNT:WLOWer?
```

Description

Sets or queries the lower limit of the pulse width of Runt trigger. The default unit is s.

Parameter

Name	Type	Range	Default
<width>	Real	1 ns to 9.9 s	1 μ s

Remarks

This command is only available when the trigger condition is set to GREater or GLESSs. To set or query the trigger condition of the Runt trigger, send the `:TRIGger:RUNT:WHEN` command.

When the trigger condition is set to GLESSs, if the set lower limit of the pulse width is greater than the lower limit, the upper limit will be automatically changed. You can send the `:TRIGger:RUNT:WUPPer` command to set or query the upper limit of the pulse width of Runt trigger.

Return Format

The query returns the pulse lower limit in scientific notation.

Example

```
:TRIGger:RUNT:WLOWer 0.01 /*Sets the lower limit of the pulse
width to 10 ms.*/
:TRIGger:RUNT:WLOWer? /*The query returns 1.000000E-2.*/
```

3.27.15.6 :TRIGger:RUNT:ALEVEL**Syntax**

```
:TRIGger:RUNT:ALEVEL <level>
```

```
:TRIGger:RUNT:ALEVEL?
```

Description

Sets or queries the upper limit of the trigger level of Runt trigger. The unit is the same as that of the current amplitude.

Parameter

Name	Type	Range	Default
<level>	Real	Lower limit to (4.5 x VerticalScale - OFFSet)	0 V

Remarks

For VerticalScale, refer to the `:CHANnel<n>:SCALE` command. For OFFSet, refer to the `:CHANnel<n>:OFFSet` command.

Return Format

The query returns the upper limit of the trigger level in scientific notation.

Example

```
:TRIGger:RUNT:ALEVEL 0.16 /*Sets the upper limit of the trigger
level to 160 mV.*/
:TRIGger:RUNT:ALEVEL? /*The query returns 1.600000E-1.*/
```

3.27.15.7 :TRIGger:RUNT:BLEVEL**Syntax**

```
:TRIGger:RUNT:BLEVEL <level>
```

```
:TRIGger:RUNT:BLEVEL?
```

Description

Sets or queries the lower limit of the trigger level of Runt trigger. The unit is the same as that of the current amplitude.

Parameter

Name	Type	Range	Default
<level>	Real	(-4.5 x VerticalScale - OFFSet) to upper limit	0 V

Remarks

For VerticalScale, refer to the `:CHANnel<n>:SCALE` command. For OFFSet, refer to the `:CHANnel<n>:OFFSet` command.

Return Format

The query returns the lower limit of the trigger level in scientific notation.

Example

```
:TRIGger:RUNT:BLEVel 0.16 /*Sets the lower limit of the trigger
level to 160 mV.*/
:TRIGger:RUNT:BLEVel? /*The query returns 1.600000E-1.*/
```

3.27.16 :TRIGger:WINDows

Window trigger provides a high trigger level and a low trigger level. The instrument triggers when the input signal passes through the high trigger level or the low trigger level.

3.27.16.1 :TRIGger:WINDows:SOURce

Syntax

```
:TRIGger:WINDows:SOURce <source>
```

```
:TRIGger:WINDows:SOURce?
```

Description

Sets or queries the trigger source of Window trigger.

Parameter

Name	Type	Range	Default
<source>	Discrete	{CHANnel1 CHANnel2 CHANnel3 CHANnel4}	CHANnel1

Remarks

N/A

Return Format

The query returns CHAN1, CHAN2, CHAN3, or CHAN4.

Example

```
:TRIGger:WINDows:SOURce CHANnel2 /*Sets the trigger source to
CHANnel2.*/
:TRIGger:WINDows:SOURce? /*The query returns CHAN2.*/
```

3.27.16.2 :TRIGger:WINDows:SLOPe**Syntax**

```
:TRIGger:WINDows:SLOPe <type>
```

```
:TRIGger:WINDows:SLOPe?
```

Description

Sets or queries the edge type of Windows trigger.

Parameter

Name	Type	Range	Default
<type>	Discrete	{POSitive NEGative RFALI}	POSitive

Remarks

- **POSitive:** triggers on the rising edge of the input signal when the voltage level is greater than the preset high trigger level.
- **NEGative:** triggers on the falling edge of the input signal when the voltage level is smaller than the preset low trigger level.
- **RFALI:** triggers on either the rising or falling edge of the input signal when the voltage level meets the preset trigger level.

Return Format

The query returns POS, NEG, or RFAL.

Example

```
:TRIGger:WINDows:SLOPe NEGative /*Sets the edge type of Windows
trigger to NEGative.*/
:TRIGger:WINDows:SLOPe? /*The query returns NEG.*/
```

3.27.16.3 :TRIGger:WINDows:POSition**Syntax**

```
:TRIGger:WINDows:POSition <pos>
```

```
:TRIGger:WINDows:POSition?
```

Description

Sets or queries the trigger position of Window trigger.

Parameter

Name	Type	Range	Default
<pos>	Discrete	{EXIT ENTer TIME}	ENTer

Remarks

- **EXIT:** triggers when the input signal exits the specified trigger level range.
- **ENTer:** triggers when the input signal enters the specified trigger level range.
- **TIME:** triggers when the accumulated hold time after the trigger signal enters the specified trigger level range is equal to the window time.

Return Format

The query returns EXIT, ENT, or TIME.

Example

```
:TRIGger:WINDows:POSition ENTer /*Sets the trigger position to
ENT.*/
:TRIGger:WINDows:POSition? /*The query returns ENT.*/
```

3.27.16.4 :TRIGger:WINDows:TIME**Syntax**

```
:TRIGger:WINDows:TIME <time>
```

```
:TRIGger:WINDows:TIME?
```

Description

Sets or queries the window time of Window trigger.

Parameter

Name	Type	Range	Default
<time>	Real	1 ns to 10 s	1μs

Remarks

N/A

Return Format

The query returns the window time in scientific notation.

Example

```
:TRIGger:WINDows:TIME 0.002 /*Sets the window time to 2 ms.*/
:TRIGger:WINDows:TIME? /*The query returns
2.000000E-3.*/
```

3.27.16.5 :TRIGger:WINDows:ALEVEL**Syntax**

```
:TRIGger:WINDows:ALEVEL <level>
```

```
:TRIGger:WINDows:ALEVEL?
```

Description

Sets or queries the upper limit of the trigger level of Window trigger. The unit is the same as that of the current amplitude.

Parameter

Name	Type	Range	Default
<level>	Real	Lower limit to (4.5 x VerticalScale - OFFSet)	0 V

Remarks

For VerticalScale, refer to the `:CHANnel<n>:SCALE` command. For OFFSet, refer to the `:CHANnel<n>:OFFSet` command.

Return Format

The query returns the upper limit of the trigger level in scientific notation.

Example

```
:TRIGger:WINDows:ALEVEL 0.16 /*Sets the upper limit of the
trigger level to 160 mV.*/
:TRIGger:WINDows:ALEVEL? /*The query returns 1.600000E-1.*/
```

3.27.16.6 :TRIGger:WINDows:BLEVEL**Syntax**

```
:TRIGger:WINDows:BLEVEL <level>
```

```
:TRIGger:WINDows:BLEVEL?
```

Description

Sets or queries the lower limit of the trigger level of Window trigger. The unit is the same as that of the current amplitude.

Parameter

Name	Type	Range	Default
<level>	Real	(-4.5 x VerticalScale - OFFSet) to upper limit	0 V

Remarks

For VerticalScale, refer to the `:CHANnel<n>:SCALE` command. For OFFSet, refer to the `:CHANnel<n>:OFFSet` command.

Return Format

The query returns the lower limit of the trigger level in scientific notation.

Example

```
:TRIGger:WINDows:BLEVel 0.05 /*Sets the lower limit of the
trigger level to 50 mV.*/
:TRIGger:WINDows:BLEVel? /*The query returns 5.000000E-2.*/
```

3.27.17 :TRIGger:DELay

In Delay trigger, you need to set Source A and Source B. The oscilloscope triggers when the time difference (ΔT) between the specified edges (Edge A and Edge B) of Source A and Source B meets the preset time limit, as shown in the figure below. Edge A and Edge B must be two neighboring edges. See the figure below.

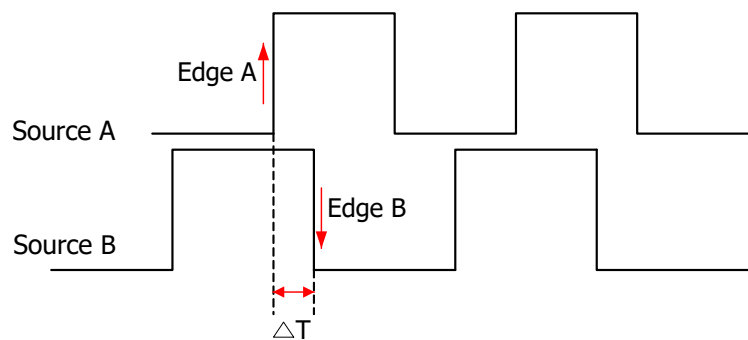

3.27.17.1 :TRIGger:DELay:SA

Syntax

```
:TRIGger:DELay:SA <source>
```

```
:TRIGger:DELay:SA?
```

Description

Sets or queries the trigger source of Source A in Delay trigger.

Parameter

Name	Type	Range	Default
<source>	Discrete	{D0 D1 D2 D3 D4 D5 D6 D7 D8 D9 D10 D11 D12 D13 D14 D15 CHANnel1 CHANnel2 CHANnel3 CHANnel4}	CHANnel1

Remarks

Digital channels (D0 to D15) are only supported by the DHO900 series.

Return Format

The query returns D0, D1, D2, D3, D4, D5, D6, D7, D8, D9, D10, D11, D12, D13, D14, D15, CHAN1, CHAN2, CHAN3, or CHAN4.

Example

```
:TRIGger:DElay:SA CHANnel2 /*Sets the trigger source A to
CHANnel2.*/
:TRIGger:DElay:SA? /*The query returns CHAN2.*/
```

3.27.17.2 :TRIGger:DElay:ASLop**Syntax**

```
:TRIGger:DElay:ASLop <slope>
```

```
:TRIGger:DElay:ASLop?
```

Description

Sets or queries the edge type of Edge A in Delay trigger.

Parameter

Name	Type	Range	Default
<slope>	Discrete	{POSitive NEGative}	POSitive

Remarks

N/A

Return Format

The query returns POS or NEG.

Example

```
:TRIGger:DElay:ASLop NEGative /*Sets the edge type of Edge A to
NEGative.*/
:TRIGger:DElay:ASLop? /*The query returns NEG.*/
```

3.27.17.3 :TRIGger:DElay:SB

Syntax

```
:TRIGger:DElay:SB <source>
```

```
:TRIGger:DElay:SB?
```

Description

Sets or queries the trigger source of Source B in Delay trigger.

Parameter

Name	Type	Range	Default
<source>	Discrete	{D0 D1 D2 D3 D4 D5 D6 D7 D8 D9 D10 D11 D12 D13 D14 D15 CHANnel1 CHANnel2 CHANnel3 CHANnel4}	CHANnel2

Remarks

Digital channels (D0 to D15) are only supported by the DHO900 series.

Return Format

The query returns D0, D1, D2, D3, D4, D5, D6, D7, D8, D9, D10, D11, D12, D13, D14, D15, CHAN1, CHAN2, CHAN3, or CHAN4.

Example

```
:TRIGger:DElay:SB CHANnel4 /*Sets the trigger source B to
CHANnel4.*/
:TRIGger:DElay:SB? /*The query returns CHAN4.*/
```

3.27.17.4 :TRIGger:DElay:BSLop

Syntax

```
:TRIGger:DElay:BSLop <slope>
```

```
:TRIGger:DElay:BSLop?
```

Description

Sets or queries the edge type of Edge B in Delay trigger.

Parameter

Name	Type	Range	Default
<slope>	Discrete	{POSitive NEGative}	POSitive

Remarks

N/A

Return Format

The query returns POS or NEG.

Example

```
:TRIGger:DElay:BSLop NEGative /*Sets the edge type of Edge B to
NEGative.*/
:TRIGger:DElay:BSLop? /*The query returns NEG.*/
```

3.27.17.5 :TRIGger:DElay:TYPE**Syntax**

```
:TRIGger:DElay:TYPE <type>
```

```
:TRIGger:DElay:TYPE?
```

Description

Sets or queries the trigger condition of the Delay trigger.

Parameter

Name	Type	Range	Default
<type>	Discrete	{GREater LESS GLESS GOUT}	GREater

Remarks

- **GREater:** triggers when the time difference (ΔT) between the specified edges of Source A and Source B is greater than the preset time limit.
- **LESS:** triggers when the time difference (ΔT) between the specified edges of Source A and Source B is smaller than the preset time limit.
- **GLESS:** triggers when the time difference (ΔT) between the specified edges of Source A and Source B is greater than the lower limit of the preset time and smaller than the upper limit of the preset time.
- **GOUT:** triggers when the time difference (ΔT) between the specified edges of Source A and Source B is smaller than the lower limit of the preset time or greater than the upper limit of the preset time.

Return Format

The query returns GRE, LESS, GLES, or GOUT.

Example

```
:TRIGger:DElay:TYpe GOUT /*Sets the trigger condition to GOUT.*/
:TRIGger:DElay:TYpe? /*The query returns GOUT.*/
```

3.27.17.6 :TRIGger:DElay:TUPPer**Syntax**

```
:TRIGger:DElay:TUPPer <time>
```

```
:TRIGger:DElay:TUPPer?
```

Description

Sets or queries the upper limit of delay time of the Delay trigger. The default unit is s.

Parameter

Name	Type	Range	Default
<time>	Real	1.01 ns to 10 s	2 μs

Remarks

This command is only available when the trigger condition is set to LESS, GLEs, or GOUT. To set or query the trigger condition of the Delay trigger, send the *:TRIGger:DElay:TYpe* command.

When the trigger condition is set to GLEs or GOUT, if the set upper limit of the delay time is smaller than the lower limit, the lower limit will be automatically changed. You can send the *:TRIGger:DElay:TLOWer* command to set or query the lower limit of the delay time of the Delay trigger.

Return Format

The query returns the upper limit of delay time in scientific notation.

Example

```
:TRIGger:DElay:TUPPer 0.002 /*Sets the upper limit of delay time
to 2 ms.*/
:TRIGger:DElay:TUPPer? /*The query returns 2.000000E-3.*/
```

3.27.17.7 :TRIGger:DElay:TLOWer**Syntax**

```
:TRIGger:DElay:TLOWer <time>
```

```
:TRIGger:DElay:TLOWer?
```

Description

Sets or queries the lower limit of delay time of the Delay trigger. The default unit is s.

Parameter

Name	Type	Range	Default
<time>	Real	1 ns to 9.9 s	1μs

Remarks

This command is only available when the trigger condition is set to GREater, GLEs, or GOUT. To set or query the trigger condition of the Delay trigger, send the `:TRIGger:DElay:TYPE` command.

When the trigger condition is set to GLEs or GOUT, if the set lower limit of the delay time is greater than the upper limit, the upper limit will be automatically changed. You can send the `:TRIGger:DElay:TUPPer` command to set or query the upper limit of the delay time of the Delay trigger.

Return Format

The query returns the lower limit of delay time in scientific notation.

Example

```
:TRIGger:DElay:TLOWer 0.002 /*Sets the lower limit of delay time
to 2 ms.*/
:TRIGger:DElay:TLOWer? /*The query returns 2.000000E-3.*/
```

3.27.17.8 :TRIGger:DElay:ALEVEL**Syntax**

```
:TRIGger:DElay:ALEVEL <level>
```

```
:TRIGger:DElay:ALEVEL?
```

Description

Sets or queries the threshold level of Source A of Delay trigger. The unit is the same as that of the current amplitude.

Parameter

Name	Type	Range	Default
<level>	Real	(-4.5 x VerticalScale - Offset) to (4.5 x VerticalScale - Offset)	0 V

Remarks

For VerticalScale, refer to the `:CHANnel<n>:SCALE` command. For OFFSet, refer to the `:CHANnel<n>:OFFSet` command.

Return Format

The query returns the threshold level of Source A in scientific notation.

Example

```
:TRIGger:DElay:ALEvel 0.16 /*Sets the threshold level of Source
A to 160 mV.*/
:TRIGger:DElay:ALEvel? /*The query returns 1.600000E-1.*/
```

3.27.17.9 :TRIGger:DElay:BLEvel**Syntax**

```
:TRIGger:DElay:BLEvel <level>
```

```
:TRIGger:DElay:BLEvel?
```

Description

Sets or queries the threshold level of Source B of Delay trigger. The unit is the same as that of the current amplitude.

Parameter

Name	Type	Range	Default
<level>	Real	(-4.5 x VerticalScale - Offset) to (4.5 x VerticalScale - Offset)	0 V

Remarks

For VerticalScale, refer to the `:CHANnel<n>:SCALE` command. For OFFSet, refer to the `:CHANnel<n>:OFFSet` command.

Return Format

The query returns the threshold level of Source B in scientific notation.

Example

```
:TRIGger:DElay BLEvel 0.05 /*Sets the threshold level of Source
B to 50 mV.*/
:TRIGger:DElay:BLEvel? /*The query returns 5.000000E-2.*/
```

3.27.18 :TRIGger:SHOLD

In setup&hold trigger, you need to set the clock source and data source. The setup time starts when the data signal passes the trigger level and ends at the coming of the specified clock edge; the hold time starts at the coming of the specified clock edge and ends when the data signal crosses the trigger level again, as shown in the figure below. The oscilloscope triggers when the setup time or hold time is smaller than the preset time.

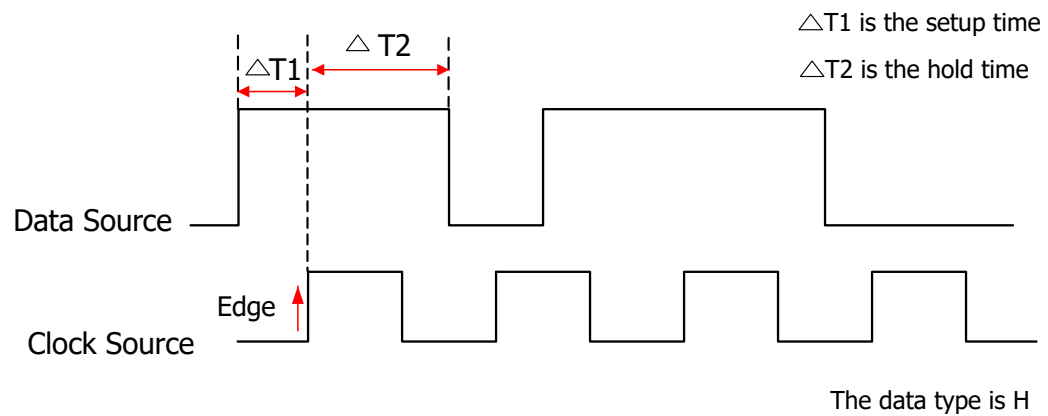

3.27.18.1 :TRIGger:SHOLd:DSRC

Syntax

```
:TRIGger:SHOLd:DSRC <source>
```

```
:TRIGger:SHOLd:DSRC?
```

Description

Sets or queries the data source of Setup&Hold trigger.

Parameter

Name	Type	Range	Default
<source>	Discrete	{D0 D1 D2 D3 D4 D5 D6 D7 D8 D9 D10 D11 D12 D13 D14 D15 CHANnel1 CHANnel2 CHANnel3 CHANnel4}	CHANnel2

Remarks

Digital channels (D0 to D15) are only supported by the DHO900 series.

Return Format

The query returns D0, D1, D2, D3, D4, D5, D6, D7, D8, D9, D10, D11, D12, D13, D14, D15, CHAN1, CHAN2, CHAN3, or CHAN4.

Example

```
:TRIGger:SHOLd:DSRC CHANnel1 /*Sets the data source to  
CHANnel1.*/  
:TRIGger:SHOLd:DSRC? /*The query returns CHAN1.*/
```

3.27.18.2 :TRIGger:SHOLd:CSRC

Syntax

```
:TRIGger:SHOLd:CSRC <source>
```

:TRIGger:SHOLd:CSRC?

Description

Sets or queries the clock source of Setup&Hold trigger.

Parameter

Name	Type	Range	Default
<source>	Discrete	{D0 D1 D2 D3 D4 D5 D6 D7 D8 D9 D10 D11 D12 D13 D14 D15 CHANnel1 CHANnel2 CHANnel3 CHANnel4}	CHANnel1

Remarks

Digital channels (D0 to D15) are only supported by the DHO900 series.

Return Format

The query returns D0, D1, D2, D3, D4, D5, D6, D7, D8, D9, D10, D11, D12, D13, D14, D15, CHAN1, CHAN2, CHAN3, or CHAN4.

Example

```
:TRIGger:SHOLd:CSRC CHANnel2 /*Sets the clock source to
CHANnel2.*/
:TRIGger:SHOLd:CSRC? /*The query returns CHAN2.*/
```

3.27.18.3 :TRIGger:SHOLd:SLOPe

Syntax

:TRIGger:SHOLd:SLOPe <slope>

:TRIGger:SHOLd:SLOPe?

Description

Sets or queries the edge type of Setup&Hold trigger.

Parameter

Name	Type	Range	Default
<slope>	Discrete	{POSitive NEGative}	POSitive

Remarks

N/A

Return Format

The query returns POS or NEG.

Example

```
:TRIGger:SHOLd:SLOPe NEGative /*Sets the edge type to
NEGative.*/
:TRIGger:SHOLd:SLOPe? /*The query returns NEG.*/
```

3.27.18.4 :TRIGger:SHOLd:PATtern**Syntax**

```
:TRIGger:SHOLd:PATtern <pattern>
```

```
:TRIGger:SHOLd:PATtern?
```

Description

Sets or queries the data type of Setup&Hold trigger.

Parameter

Name	Type	Range	Default
<pattern>	Discrete	{H L}	H

Remarks

- **H:** indicates high level.
- **L:** indicates low level.

Return Format

The query returns H or L.

Example

```
:TRIGger:SHOLd:PATtern L /*Sets data type to L.*/
:TRIGger:SHOLd:PATtern? /*The query returns L.*/
```

3.27.18.5 :TRIGger:SHOLd:TYPE**Syntax**

```
:TRIGger:SHOLd:TYPE <type>
```

```
:TRIGger:SHOLd:TYPE?
```

Description

Sets or queries the trigger condition of Setup/Hold trigger.

Parameter

Name	Type	Range	Default
<type>	Discrete	{SETup HOLD SETHold}	SETup

Remarks

- **SETup**: the oscilloscope triggers when the setup time is smaller than the specified setup time.
- **HOLD**: the oscilloscope triggers when the hold time is smaller than the specified hold time.
- **SETHold**: the oscilloscope triggers when the setup time or hold time is smaller than the specified time value.

Return Format

The query returns SET, HOLD, or SETH.

Example

```
:TRIGger:SHOLd:TYPE SETHold /*Sets the trigger condition to
SETHold.*/
:TRIGger:SHOLd:TYPE? /*The query returns SETH.*/
```

3.27.18.6 :TRIGger:SHOLd:STIME**Syntax**

```
:TRIGger:SHOLd:STIME <time>
```

```
:TRIGger:SHOLd:STIME?
```

Description

Sets or queries the setup time of Setup&Hold trigger. The default unit is s.

Parameter

Name	Type	Range	Default
<time>	Real	1 ns to 10 s	2 μ s

Remarks

- Setup time indicates the time that the data remain stable and unchanged before the specified clock edge arrives.
- This command is only available when the hold type is SETup or SETHOLd.

Return Format

The query returns the setup time value in scientific notation.

Example

```
:TRIGger:SHOLd:STIME 0.002 /*Sets the setup time to 2 ms.*/
:TRIGger:SHOLd:STIME? /*The query returns 2.000000E-3.*/
```

3.27.18.7 :TRIGger:SHOLd:HTIME**Syntax**

```
:TRIGger:SHOLd:HTIME <time>
```

```
:TRIGger:SHOLd:HTIME?
```

Description

Sets or queries the hold time of Setup&Hold trigger. The default unit is s.

Parameter

Name	Type	Range	Default
<time>	Real	1 ns to 10 s	1 μ s

Remarks

- Hold time indicates the time that the data remain stable and unchanged after the specified clock edge arrives.
- This command is only available when the hold type is HOLD or SETHOLD.

Return Format

The query returns the hold time value in scientific notation.

Example

```
:TRIGger:SHOLd:HTIME 0.002 /*Sets the hold time to 2 ms.*/
:TRIGger:SHOLd:HTIME? /*The query returns 2.000000E-3.*/
```

3.27.18.8 :TRIGger:SHOLd:DLEVel**Syntax**

```
:TRIGger:SHOLd:DLEVel <level>
```

```
:TRIGger:SHOLd:DLEVel?
```

Description

Sets or queries the trigger level of the data source. The unit is the same as that of the current amplitude.

Parameter

Name	Type	Range	Default
<level>	Real	Analog channel: (-4.5 x VerticalScale - Offset) to (4.5 x VerticalScale - Offset) Digital channel: -20 V to 20 V	0 V

Remarks

For VerticalScale, refer to the `:CHANnel<n>:SCALE` command. For OFFSet, refer to the `:CHANnel<n>:OFFSet` command.

Return Format

The query returns the trigger level of the data source in scientific notation.

Example

```
:TRIGger:SHOLd:DLEVel 0.16 /*Sets the trigger level of the data
source to 160 mV.*/
:TRIGger:SHOLd:DLEVel? /*The query returns 1.600000E-1.*/
```

3.27.18.9 :TRIGger:SHOLd:CLEVel**Syntax**

```
:TRIGger:SHOLd:CLEVel <level>
```

```
:TRIGger:SHOLd:CLEVel?
```

Description

Sets or queries the trigger level of the clock source. The unit is the same as that of the current amplitude.

Parameter

Name	Type	Range	Default
<level>	Real	Analog channel: (-4.5 x VerticalScale - Offset) to (4.5 x VerticalScale - Offset) Digital channel: -20 V to 20 V	0 V

Remarks

For VerticalScale, refer to the `:CHANnel<n>:SCALE` command. For OFFSet, refer to the `:CHANnel<n>:OFFSet` command.

Return Format

The query returns the trigger level of the clock source in scientific notation.

Example

```
:TRIGger:SHOLd:CLEVel 0.05 /*Sets the trigger level of the
clock source to 50 mV.*/
:TRIGger:SHOLd:CLEVel? /*The query returns 5.000000E-2.*/
```

3.27.19 :TRIGger:NEDGE

The Nth edge trigger lets you to trigger on the Nth edge that occurs after a specified idle time. For example, in the waveform as shown in the figure below, the instrument should trigger on the second rising edge after the specified idle time (the time between two neighboring rising edges), and the idle time should be within the range between P and M ($P < \text{Idle Time} < M$). Wherein, M is the time between the first rising edge and its previous rising edge; P is the maximum time between the rising edges that participate in counting.

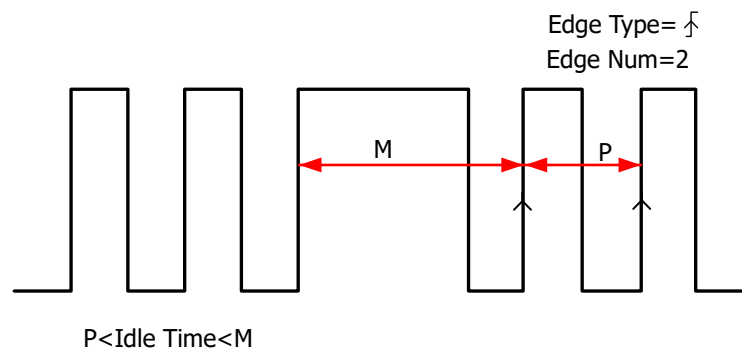
**3.27.19.1 :TRIGger:NEDGE:SOURce****Syntax**

```
:TRIGger:NEDGE:SOURce <source>
:TRIGger:NEDGE:SOURce?
```

Description

Sets or queries the trigger source of Edge trigger.

Parameter

Name	Type	Range	Default
<source>	Discrete	{D0 D1 D2 D3 D4 D5 D6 D7 D8 D9 D10 D11 D12 D13 D14 D15 CHANnel1 CHANnel2 CHANnel3 CHANnel4}	CHANnel1

Remarks

Digital channels (D0 to D15) are only supported by the DHO900 series.

Return Format

The query returns D0, D1, D2, D3, D4, D5, D6, D7, D8, D9, D10, D11, D12, D13, D14, D15, CHAN1, CHAN2, CHAN3, or CHAN4.

Example

```
:TRIGger:NEDGE:SOURce CHANnel2 /*Sets the trigger source to
CHANnel2.*/
:TRIGger:NEDGE:SOURce? /*The query returns CHAN2.*/
```

3.27.19.2 :TRIGger:NEDGE:SLOPe**Syntax**

```
:TRIGger:NEDGE:SLOPe <slope>
```

```
:TRIGger:NEDGE:SLOPe?
```

Description

Sets or queries the edge type of the Nth Edge trigger.

Parameter

Name	Type	Range	Default
<slope>	Discrete	{POSitive NEGative}	POSitive

Remarks

- **POSitive:** indicates that the oscilloscope triggers on the rising edge of the input signal when the voltage level meets the preset trigger level.
- **NEGative:** indicates that the oscilloscope triggers on the falling edge of the input signal when the voltage level meets the preset trigger level.

Return Format

The query returns POS or NEG.

Example

```
:TRIGger:NEDGE:SLOPe NEGative /*Sets the edge type to
NEGative.*/
:TRIGger:NEDGE:SLOPe? /*The query returns NEG.*/
```

3.27.19.3 :TRIGger:NEDGe:IDLE

Syntax

```
:TRIGger:NEDGe:IDLE <time>
```

```
:TRIGger:NEDGe:IDLE?
```

Description

Sets or queries the idle time of the Nth Edge trigger. The default unit is s.

Parameter

Name	Type	Range	Default
<time>	Real	16 ns to 10 s	1μs

Remarks

N/A

Return Format

The query returns the idle time in scientific notation.

Example

```
:TRIGger:NEDGe:IDLE 0.002 /*Sets the idle time to 2 ms.*/
:TRIGger:NEDGe:IDLE? /*The query returns 2.000000E-3.*/
```

3.27.19.4 :TRIGger:NEDGe:EDGE

Syntax

```
:TRIGger:NEDGe:EDGE <edge>
```

```
:TRIGger:NEDGe:EDGE?
```

Description

Sets or queries the number of edges of the Nth Edge trigger.

Parameter

Name	Type	Range	Default
<edge>	Integer	1 to 65535	1

Remarks

N/A

Return Format

The query returns an integer ranging from 1 to 65535.

Example

```
:TRIGger:NEDGE:EDGE 20 /*Sets the number of edges to 20.*/
:TRIGger:NEDGE:EDGE? /*The query returns 20.*/
```

3.27.19.5 :TRIGger:NEDGE:LEVEL**Syntax**

```
:TRIGger:NEDGE:LEVEL <level>
```

```
:TRIGger:NEDGE:LEVEL?
```

Description

Sets or queries the trigger level of the Nth Edge trigger. The unit is the same as that of current amplitude.

Parameter

Name	Type	Range	Default
<level>	Real	Analog channel: (-4.5 x VerticalScale - Offset) to (4.5 x VerticalScale - Offset) Digital channel: -20 V to 20 V	0 V

Remarks

For VerticalScale, refer to the `:CHANnel<n>:SCALE` command. For OFFSet, refer to the `:CHANnel<n>:OFFSet` command.

Return Format

The query returns the trigger level in scientific notation.

Example

```
:TRIGger:NEDGE:LEVEL 0.16 /*Sets the trigger level to 160 mV.*/
:TRIGger:NEDGE:LEVEL? /*The query returns 1.600000E-1.*/
```

3.27.20 :TRIGger:RS232

RS232 bus is a serial communication mode used in data transmission between PCs or between a PC and a terminal. In RS232 serial protocol, a character is transmitted as a frame of data. The frame consists of 1 start bit, 5-8 data bits, 1 check bit, and 1-2 stop bits. Its format is as shown in the figure below. This series oscilloscope triggers when detecting the start frame, error frame, check error, or the specified data of the RS232 signal.

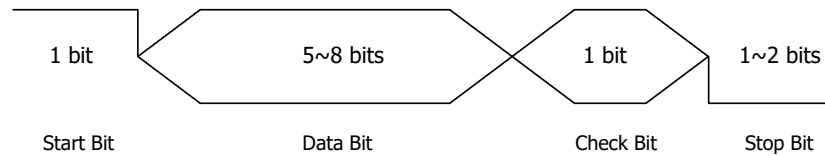

Figure 3.7 Schematic Diagram of RS232 Protocol

3.27.20.1 :TRIGger:RS232:SOURce

Syntax

```
:TRIGger:RS232:SOURce <source>
```

```
:TRIGger:RS232:SOURce?
```

Description

Sets or queries the trigger source of RS232 trigger.

Parameter

Name	Type	Range	Default
<source>	Discrete	{D0 D1 D2 D3 D4 D5 D6 D7 D8 D9 D10 D11 D12 D13 D14 D15 CHANnel1 CHANnel2 CHANnel3 CHANnel4}	CHANnel1

Remarks

Digital channels (D0 to D15) are only supported by the DHO900 series.

Return Format

The query returns D0, D1, D2, D3, D4, D5, D6, D7, D8, D9, D10, D11, D12, D13, D14, D15, CHAN1, CHAN2, CHAN3, or CHAN4.

Example

```
:TRIGger:RS232:SOURce CHANnel2 /*Sets the trigger source to
CHANnel2.*/
:TRIGger:RS232:SOURce? /*The query returns CHAN2.*/
```

3.27.20.2 :TRIGger:RS232:LEVel

Syntax

```
:TRIGger:RS232:LEVel <level>
```

```
:TRIGger:RS232:LEVel?
```

Description

Sets or queries the trigger level of RS232 trigger. The unit is the same as that of the current amplitude.

Parameter

Name	Type	Range	Default
<level>	Real	Analog channel: (-4.5 x VerticalScale - Offset) to (4.5 x VerticalScale - Offset) Digital channel: -20 V to 20 V	0 V

Remarks

For VerticalScale, refer to the `:CHANnel<n>:SCALE` command. For OFFSET, refer to the `:CHANnel<n>:OFFSet` command.

Return Format

The query returns the trigger level in scientific notation.

Example

```
:TRIGger:RS232:LEVel 0.16 /*Sets the trigger level to 160 mV.*/
:TRIGger:RS232:LEVel? /*The query returns 1.600000E-1.*/
```

3.27.20.3 :TRIGger:RS232:POLarity**Syntax**

```
:TRIGger:RS232:POLarity <polarity>
```

```
:TRIGger:RS232:POLarity?
```

Description

Sets or queries the pulse polarity of RS232 trigger.

Parameter

Name	Type	Range	Default
<polarity>	Discrete	{POSitive NEGative}	POSitive

Remarks

N/A

Return Format

The query returns POS or NEG.

Example

```
:TRIGger:RS232:POLarity POSitive /*Sets the pulse polarity of
RS232 trigger to POSitive.*/
:TRIGger:RS232:POLarity? /*The query returns POS.*/
```

3.27.20.4 :TRIGger:RS232:WHEN**Syntax**

```
:TRIGger:RS232:WHEN <when>
```

```
:TRIGger:RS232:WHEN?
```

Description

Sets or queries the trigger condition of RS232 trigger.

Parameter

Name	Type	Range	Default
<when>	Discrete	{START ERRor CERRor DATA}	START

Remarks

- **START:** triggers at the start of a frame.
- **ERRor:** triggers when an error frame is found.
- **CERRor:** triggers when a check error is found.
- **DATA:** triggers on the last bit of the preset data bits.

Return Format

The query returns STAR, ERR, CERR, or DATA.

Example

```
:TRIGger:RS232:WHEN ERRor /*Sets the trigger condition to
ERRor.*/
:TRIGger:RS232:WHEN? /*The query returns ERR.*/
```

3.27.20.5 :TRIGger:RS232:DATA**Syntax**

```
:TRIGger:RS232:DATA <data>
```

```
:TRIGger:RS232:DATA?
```

Description

Sets or queries the data value of RS232 trigger when the trigger condition is "Data".

Parameter

Name	Type	Range	Default
<data>	Integer	0 to 2^n-1	0

Remarks

In the expression 2^n-1 , n indicates the current data width, and its available value can be 5, 6, 7, and 8. You can send the `:TRIGger:RS232:WIDTh` command to set or query the data width.

Return Format

The query returns an integer.

Example

```
:TRIGger:RS232:DATA 10 /*Sets the data value to 10.*/
:TRIGger:RS232:DATA? /*The query returns 10.*/
```

3.27.20.6 :TRIGger:RS232:BAUD**Syntax**

```
:TRIGger:RS232:BAUD <baud>
```

```
:TRIGger:RS232:BAUD?
```

Description

Sets or queries the baud rate of RS232 trigger. The default unit is bps.

Parameter

Name	Type	Range	Default
<baud>	Integer	1 bps to 20 Mbps	9600 bps

Remarks

If the baud rate is set to a value with "M", then "A" should be added at the end of the value. For example, if you send 5M, you need to send 5MA.

Return Format

The query returns an integer ranging from 1 bps to 20 Mbps.

Example

```
:TRIGger:RS232:BAUD 4800 /*Sets the baud rate to 4800 bps.*/
:TRIGger:RS232:BAUD? /*The query returns 4800.*/
```

3.27.20.7 :TRIGger:RS232:WIDTh

Syntax

```
:TRIGger:RS232:WIDTh <width>
```

```
:TRIGger:RS232:WIDTh?
```

Description

Sets or queries the data width of RS232 trigger when the trigger condition is "Data".

Parameter

Name	Type	Range	Default
<width>	Discrete	{5 6 7 8}	8

Remarks

N/A

Return Format

The query returns 5, 6, 7, or 8.

Example

```
:TRIGger:RS232:WIDTh 6 /*Sets the data width to 6.*/
:TRIGger:RS232:WIDTh? /*The query returns 6.*/
```

3.27.20.8 :TRIGger:RS232:STOP

Syntax

```
:TRIGger:RS232:STOP <bit>
```

```
:TRIGger:RS232:STOP?
```

Description

Sets or queries the stop bits of RS232 trigger.

Parameter

Name	Type	Range	Default
<bit>	Discrete	{1 1.5 2}	1

Remarks

N/A

Return Format

The query returns 1, 1.5, or 2.

Example

```
:TRIGger:RS232:STOP 2 /*Sets the stop bits to 2.*/
:TRIGger:RS232:STOP? /*The query returns 2.*/
```

3.27.20.9 :TRIGger:RS232:PARity**Syntax**

```
:TRIGger:RS232:PARity <parity>
```

```
:TRIGger:RS232:PARity?
```

Description

Sets or queries the check mode of RS232 trigger.

Parameter

Name	Type	Range	Default
<parity>	Discrete	{EVEN ODD NONE}	NONE

Remarks

N/A

Return Format

The query returns EVEN, ODD, or NONE.

Example

```
:TRIGger:RS232:PARity EVEN /*Sets the check mode to EVEN.*/
:TRIGger:RS232:PARity? /*The query returns EVEN.*/
```

3.27.21 :TRIGger:IIC

I2C is a 2-wire serial bus used to connect the microcontroller and its peripheral device. It is a bus standard widely used in the microelectronic communication control field.

The I2C serial bus consists of SCL and SDA. Its transmission rate is determined by SCL, and its transmission data is determined by SDA, as shown in the figure below. The instrument triggers on the start condition, restart, stop, missing acknowledgment, specific device address, or data value. Besides, it can also trigger on the specific device address and data values at the same time.

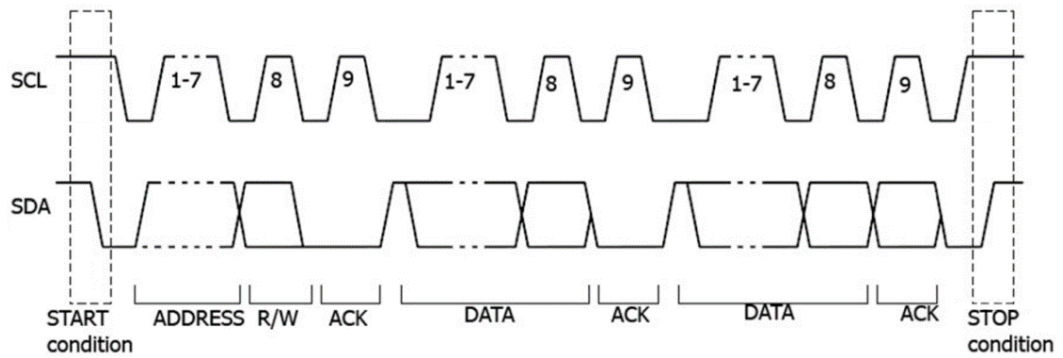

Figure 3.8 Sequence Diagram of I2C Protocol

3.27.21.1 :TRIGger:IIC:SCL

Syntax

```
:TRIGger:IIC:SCL <source>
```

```
:TRIGger:IIC:SCL?
```

Description

Sets or queries the source channel of the clock line of I2C trigger.

Parameter

Name	Type	Range	Default
<source>	Discrete	{D0 D1 D2 D3 D4 D5 D6 D7 D8 D9 D10 D11 D12 D13 D14 D15 CHANnel1 CHANnel2 CHANnel3 CHANnel4}	CHANnel1

Remarks

Digital channels (D0 to D15) are only supported by the DHO900 series.

Return Format

The query returns D0, D1, D2, D3, D4, D5, D6, D7, D8, D9, D10, D11, D12, D13, D14, D15, CHAN1, CHAN2, CHAN3, or CHAN4.

Example

```
:TRIGger:IIC:SCL CHANnel2 /*Sets the clock source to CHANnel2.*/
:TRIGger:IIC:SCL? /*The query returns CHAN2.*/
```

3.27.21.2 :TRIGger:IIC:CLeVel

Syntax

```
:TRIGger:IIC:CLeVel </level>
```

:TRIGger:IIC:CLeVel?

Description

Sets or queries the trigger level of the clock line in I2C trigger. The unit is the same as that of the current amplitude.

Parameter

Name	Type	Range	Default
<level>	Real	Analog channel: (-4.5 x VerticalScale - Offset) to (4.5 x VerticalScale - Offset) Digital channel: -20 V to 20 V	0 V

Remarks

For VerticalScale, refer to the **:CHANnel<n>:SCALE** command. For OFFSet, refer to the **:CHANnel<n>:OFFSet** command.

Return Format

The query returns the trigger level in scientific notation.

Example

```
:TRIGger:IIC:CLeVel 0.16 /*Sets the trigger level to 160 mV.*/
:TRIGger:IIC:CLeVel? /*The query returns 1.600000E-1.*/
```

3.27.21.3 :TRIGger:IIC:SDA

Syntax

:TRIGger:IIC:SDA <source>

:TRIGger:IIC:SDA?

Description

Sets or queries the source channel of the data line of I2C trigger.

Parameter

Name	Type	Range	Default
<source>	Discrete	{D0 D1 D2 D3 D4 D5 D6 D7 D8 D9 D10 D11 D12 D13 D14 D15 CHANnel1 CHANnel2 CHANnel3 CHANnel4}	CHANnel2

Remarks

Digital channels (D0 to D15) are only supported by the DHO900 series.

Return Format

The query returns D0, D1, D2, D3, D4, D5, D6, D7, D8, D9, D10, D11, D12, D13, D14, D15, CHAN1, CHAN2, CHAN3, or CHAN4.

Example

```
:TRIGger:IIC:SDA CHANnel2 /*Sets the data source to CHANnel2.*/
:TRIGger:IIC:SDA? /*The query returns CHAN2.*/
```

3.27.21.4 :TRIGger:IIC:DLEVel**Syntax**

```
:TRIGger:IIC:DLEVel <level>
```

```
:TRIGger:IIC:DLEVel?
```

Description

Sets or queries the trigger level of the data line in I2C trigger. The unit is the same as that of the current amplitude.

Parameter

Name	Type	Range	Default
<level>	Real	Analog channel: (-4.5 x VerticalScale - Offset) to (4.5 x VerticalScale - Offset) Digital channel: -20 V to 20 V	0 V

Remarks

For VerticalScale, refer to the `:CHANnel<n>:SCALE` command. For OFFSet, refer to the `:CHANnel<n>:OFFSet` command.

Return Format

The query returns the trigger level in scientific notation.

Example

```
:TRIGger:IIC:DLEVel 0.16 /*Sets the trigger level to 160 mV.*/
:TRIGger:IIC:DLEVel? /*The query returns 1.600000E-1.*/
```

3.27.21.5 :TRIGger:IIC:WHEN**Syntax**

```
:TRIGger:IIC:WHEN <when>
```

```
:TRIGger:IIC:WHEN?
```

Description

Sets or queries the trigger condition of I2C trigger.

Parameter

Name	Type	Range	Default
<when>	Discrete	{START REStart STOP NACKnowledge ADDRess DATA ADATa}	START

Remarks

- **START:** indicates that the oscilloscope triggers when SCL is high level and SDA transitions from high level to low level.
- **REStart:** indicates that the oscilloscope triggers when another start condition occurs before a stop condition.
- **STOP:** indicates that the oscilloscope triggers when SCL is high level and SDA transitions from low level to high level.
- **NACKnowledge:** indicates missing acknowledgment. The oscilloscope triggers when SDA is high level during the acknowledgment of the SCL bit.
- **ADDRess:** indicates that the oscilloscope searches for the specified address and triggers on the read/write bit.
- **DATA:** indicates that the oscilloscope searches for the specified data on the data line (SDA) and triggers on the clock line (SCL) of the jumping edge of the last bit of the data.
- **ADATa:** indicates that the oscilloscope searches for the specified address and data, and then triggers when both the address and data meet the conditions.

Return Format

The query returns STAR, REST, STOP, NACK, ADDR, DATA, or ADAT.

Example

```
:TRIGger:IIC:WHEN REStart /*Sets the trigger condition to
REStart.*/
:TRIGger:IIC:WHEN? /*The query returns REST.*/
```

3.27.21.6 :TRIGger:IIC:AWIDth

Syntax

```
:TRIGger:IIC:AWIDth <bits>
```

```
:TRIGger:IIC:AWIDth?
```

Description

Sets or queries the address width of I2C trigger when the trigger condition is "ADDRESS" or "ADATa".

Parameter

Name	Type	Range	Default
<bits>	Discrete	{7 8 10}	7

Remarks

N/A

Return Format

The query returns 7, 8, or 10.

Example

```
:TRIGger:IIC:AWIDth 10 /*Sets the address width to 10.*/
:TRIGger:IIC:AWIDth? /*The query returns 10.*/
```

3.27.21.7 :TRIGger:IIC:ADDRess

Syntax

```
:TRIGger:IIC:ADDRess <address>
```

```
:TRIGger:IIC:ADDRess?
```

Description

Sets or queries the address of I2C trigger when the trigger condition is "ADDRESS" or "ADATa".

Parameter

Name	Type	Range	Default
<address>	Integer	0 to 2^n-1	0

Remarks

In the expression 2^n-1 , n indicates the current address width. Its range is from 0 to 127, 0 to 255, or 0 to 1,023.

Return Format

The query returns the address in integer.

Example

```
:TRIGger:IIC:ADDRess 100 /*Sets the address to 100.*/
:TRIGger:IIC:ADDRess? /*The query returns 100.*/
```

3.27.21.8 :TRIGger:IIC:DIRection**Syntax**

```
:TRIGger:IIC:DIRection <direction>
```

```
:TRIGger:IIC:DIRection?
```

Description

Sets or queries the data direction of I2C trigger when the trigger condition is "ADDRess" or "ADATa".

Parameter

Name	Type	Range	Default
<dir>	Discrete	{READ WRITe RWRite}	WRITe

Remarks

This command is unavailable when the address width is set to 8.

Return Format

The query returns READ, WRIT, or RWR.

Example

```
:TRIGger:IIC:DIRection RWRite /*Sets the data direction to
RWRite.*/
:TRIGger:IIC:DIRection? /*The query returns RWR.*/
```

3.27.21.9 :TRIGger:IIC:DBYTes**Syntax**

```
:TRIGger:IIC:DBYTes <bytes>
```

```
:TRIGger:IIC:DBYTes?
```

Description

Sets or queries of the data bytes of I2C trigger when the trigger condition is "DATA" or "ADATa".

Parameter

Name	Type	Range	Default
<bytes>	Real	1 to 5	1

Remarks

N/A

Return Format

The query returns the data bytes in scientific notation.

Example

```
:TRIGger:IIC:DBYtes 3 /*Sets the data bytes to 3 when the
trigger condition is "DATA" or "ADATa".*/
:TRIGger:IIC:DBYtes? /*The query returns 3.*/
```

3.27.21.10 :TRIGger:IIC:DATA**Syntax**

```
:TRIGger:IIC:DATA <data>
```

```
:TRIGger:IIC:DATA?
```

Description

Sets or queries the data value of I2C trigger when the trigger condition is "DATA" or "ADATa".

Parameter

Name	Type	Range	Default
<data>	Integer	0 to 2 ⁴⁰ -1	0

Remarks

The settable range of <data> is affected by the data bytes. You can send the `:TRIGger:IIC:DBYtes` command to set the data bytes. The maximum byte length can be set to 5, that is, 40-bit binary data. Therefore, the range of <data> is from 0 to 2⁴⁰-1.

Return Format

The query returns an integer.

Example

```
:TRIGger:IIC:DATA 64 /*Sets the data value to 64.*/
:TRIGger:IIC:DATA? /*The query returns 64.*/
```

3.27.21.11 :TRIGger:IIC:CURRbit

Syntax

```
:TRIGger:IIC:CURRbit <currbit>
```

```
:TRIGger:IIC:CURRbit?
```

Description

Sets or queries the current bit of the I2C trigger data.

Parameter

Name	Type	Range	Default
<currbit>	Integer	0 to 39	0

Remarks

After configuring the settings for this command, you can send the *:TRIGger:IIC:CODE* command to set or modify the set bit data.

Return Format

The query returns an integer ranging from 0 to 39.

Example

```
:TRIGger:IIC:CURRbit 8 /*Sets the current bit of I2C trigger
data to 8. That is, the oscilloscope triggers on the 9th bit of
I2C trigger data.*/
:TRIGger:IIC:CURRbit? /*The query returns 8.*/
```

3.27.21.12 :TRIGger:IIC:CODE

Syntax

```
:TRIGger:IIC:CODE <code>
```

```
:TRIGger:IIC:CODE?
```

Description

Sets or queries the data value of a certain bit of I2C trigger.

Parameter

Name	Type	Range	Default
<code>	Discrete	{0 1 255}	255

Remarks

When <code> is set to 255, it indicates the data value can be any value.

After sending the `:TRIGger:IIC:CURRbit` command to set the specified bit, you can send this command to query or modify the value of the specified data bit.

Return Format

The query returns 0, 1, or 255.

Example

```
:TRIGger:IIC:CODE 0 /*Sets the data value to 0.*/
:TRIGger:IIC:CODE? /*The query returns 0.*/
```

3.27.22 :TRIGger:SPI

In SPI trigger, after the CS or timeout condition is satisfied, the oscilloscope triggers when the specified data is found. When using SPI trigger, you need to specify the CLK clock sources and MISO data sources.

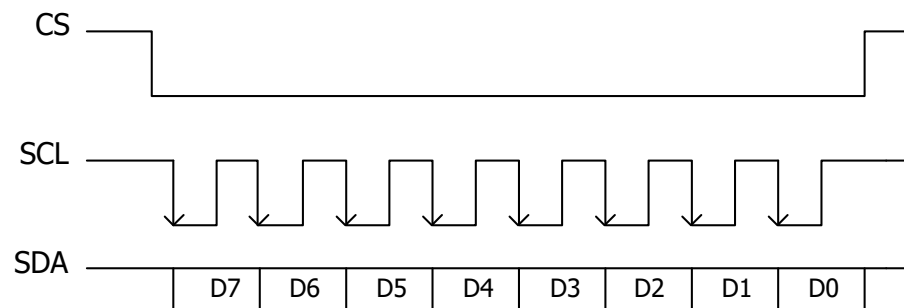

Figure 3.9 Sequential Chart of SPI Bus

3.27.22.1 :TRIGger:SPI:CLK

Syntax

```
:TRIGger:SPI:CLK <source>
```

```
:TRIGger:SPI:CLK?
```

Description

Sets or queries the channel source of the clock line of SPI trigger.

Parameter

Name	Type	Range	Default
<source>	Discrete	{D0 D1 D2 D3 D4 D5 D6 D7 D8 D9 D10 D11 D12 D13 D14 D15 CHANnel1 CHANnel2 CHANnel3 CHANnel4}	CHANnel1

Remarks

Digital channels (D0 to D15) are only supported by the DHO900 series.

Return Format

The query returns D0, D1, D2, D3, D4, D5, D6, D7, D8, D9, D10, D11, D12, D13, D14, D15, CHAN1, CHAN2, CHAN3, or CHAN4.

Example

```
:TRIGger:SPI:CLK CHANnel3 /*Sets the channel source of the data
line of SPI trigger to CHANnel3.*/
:TRIGger:SPI:CLK? /*The query returns CHAN3.*/
```

3.27.22.2 :TRIGger:SPI:SCL**Syntax**

```
:TRIGger:SPI:SCL <source>
```

```
:TRIGger:SPI:SCL?
```

Description

Sets or queries the channel source of the clock line of SPI trigger.

Parameter

Name	Type	Range	Default
<source>	Discrete	{CHANnel1 CHANnel2 CHANnel3 CHANnel4 D0 D1 D2 D3 D4 D5 D6 D7 D8 D9 D10 D11 D12 D13 D14 D15}	CHANnel1

Remarks

This command exists for backwards compatibility. Use the command *:TRIGger:SPI:CLK*.

Digital channels (D0 to D15) are only supported by the DHO900 series.

Return Format

The query returns D0, D1, D2, D3, D4, D5, D6, D7, D8, D9, D10, D11, D12, D13, D14, D15, CHAN1, CHAN2, CHAN3, or CHAN4.

Example

```
:TRIGger:SPI:SCL CHANnel1 /*Sets the channel source of the clock
line to CHANnel1.*/
:TRIGger:SPI:SCL? /*The query returns CHAN1.*/
```

3.27.22.3 :TRIGger:SPI:CLeVel

Syntax

```
:TRIGger:SPI:CLeVel <level>
```

```
:TRIGger:SPI:CLeVel?
```

Description

Sets or queries the trigger level of the clock channel of SPI trigger. The unit is the same as that of the current amplitude.

Parameter

Name	Type	Range	Default
<level>	Real	Analog channel: (-4.5 x VerticalScale - OFFSet) to (4.5 x VerticalScale - OFFSet) Digital channel: -20 V to 20 V	0 V

Remarks

For VerticalScale, refer to the `:CHANnel<n>:SCALe` command. For OFFSet, refer to the `:CHANnel<n>:OFFSet` command.

Return Format

The query returns the trigger level in scientific notation.

Example

```
:TRIGger:SPI:CLeVel 0.16 /*Sets the trigger level to 160 mV.*/  
:TRIGger:SPI:CLeVel? /*The query returns 1.600000E-1.*/
```

3.27.22.4 :TRIGger:SPI:SLOPe

Syntax

```
:TRIGger:SPI:SLOPe <slope>
```

```
:TRIGger:SPI:SLOPe?
```

Description

Sets or queries the type of the clock edge of SPI trigger.

Parameter

Name	Type	Range	Default
<slope>	Discrete	{POSitive NEGative}	POSitive

Remarks

- **POSitive:** samples the data on the rising edge of the clock.
- **NEGative:** samples the data on the falling edge of the clock.

Return Format

The query returns POS or NEG.

Example

```
:TRIGger:SPI:SLOPe POSitive /*Sets the clock edge to POSitive.*/
:TRIGger:SPI:SLOPe? /*The query returns POS.*/
```

3.27.22.5 :TRIGger:SPI:MISO**Syntax**

```
:TRIGger:SPI:MISO <source>
```

```
:TRIGger:SPI:MISO?
```

Description

Sets or queries the channel source of the data line of SPI trigger.

Parameter

Name	Type	Range	Default
<source>	Discrete	{D0 D1 D2 D3 D4 D5 D6 D7 D8 D9 D10 D11 D12 D13 D14 D15 CHANnel1 CHANnel2 CHANnel3 CHANnel4}	CHANnel2

Remarks

Digital channels (D0 to D15) are only supported by the DHO900 series.

Return Format

The query returns D0, D1, D2, D3, D4, D5, D6, D7, D8, D9, D10, D11, D12, D13, D14, D15, CHAN1, CHAN2, CHAN3, or CHAN4.

Example

```
:TRIGger:SPI:MISO CHANnel3 /*Sets the channel source of the data
line of SPI trigger to CHANnel3.*/
:TRIGger:SPI:MISO? /*The query returns CHAN3.*/
```

3.27.22.6 :TRIGger:SPI:SDA**Syntax**

```
:TRIGger:SPI:SDA <source>
```

:TRIGger:SPI:SDA?

Description

Sets or queries the channel source of the data line of SPI trigger.

Parameter

Name	Type	Range	Default
<source>	Discrete	{D0 D1 D2 D3 D4 D5 D6 D7 D8 D9 D10 D11 D12 D13 D14 D15 CHANnel1 CHANnel2 CHANnel3 CHANnel4}	CHANnel2

Remarks

Digital channels (D0 to D15) are only supported by the DHO900 series.

Return Format

The query returns D0, D1, D2, D3, D4, D5, D6, D7, D8, D9, D10, D11, D12, D13, D14, D15, CHAN1, CHAN2, CHAN3, or CHAN4.

Example

```
:TRIGger:SPI:SDA CHANnel2 /*Sets the channel source of the data
line of SPI trigger to CHANnel2.*/
:TRIGger:SPI:SDA? /*The query returns CHAN2.*/
```

3.27.22.7 :TRIGger:SPI:DLEVel

Syntax

:TRIGger:SPI:DLEVel <level>

:TRIGger:SPI:DLEVel?

Description

Sets or queries the trigger level of the data channel of SPI trigger. The unit is the same as that of the current amplitude.

Parameter

Name	Type	Range	Default
<level>	Real	Analog channel: (-4.5 x VerticalScale - OFFSET) to (4.5 x VerticalScale - OFFSET) Digital channel: -20 V to 20 V	0 V

Remarks

For VerticalScale, refer to the `:CHANnel<n>:SCALE` command. For Offset, refer to the `:CHANnel<n>:OFFSET` command.

Return Format

The query returns the trigger level in scientific notation.

Example

```
:TRIGger:SPI:DLEVel 0.16 /*Sets the trigger level to 160 mV.*/
:TRIGger:SPI:DLEVel? /*The query returns 1.600000E-1.*/
```

3.27.22.8 :TRIGger:SPI:WHEN**Syntax**

```
:TRIGger:SPI:WHEN <when>
```

```
:TRIGger:SPI:WHEN?
```

Description

Sets or queries the trigger condition of SPI trigger.

Parameter

Name	Type	Range	Default
<when>	Discrete	{CS TIMEout}	CS

Remarks

- CS: if the CS signal is valid, the oscilloscope will trigger when the data (SDA) satisfying the trigger conditions is found.
- TIMEout: the oscilloscope starts to search for the data (MISO) on which to trigger after the clock signal (CLK) stays in the idle state for a specified period of time.

For DHO800 series, only 4-channel models support the CS setting for SPI trigger condition.

Return Format

The query returns CS or TIM.

Example

```
:TRIGger:SPI:WHEN TIMEout /*Sets the trigger condition to
TIMEout.*/
:TRIGger:SPI:WHEN? /*The query returns TIM.*/
```

3.27.22.9 :TRIGger:SPI:CS

Syntax

```
:TRIGger:SPI:CS <source>
```

```
:TRIGger:SPI:CS?
```

Description

Sets or queries the source channel of the CS line when the trigger condition of SPI is set to CS.

Parameter

Name	Type	Range	Default
<source>	Discrete	{CHANnel1 CHANnel2 CHANnel3 CHANnel4 D0 D1 D2 D3 D4 D5 D6 D7 D8 D9 D10 D11 D12 D13 D14 D15}	CHANnel3

Remarks

This command is valid only when the trigger condition of SPI is set to CS. You can send *:TRIGger:SPI:WHEN* to set or query the trigger condition of SPI trigger.

Only DHO900 series supports the digital channels D0-D15.

For DHO800 series, only 4-channel models support this command.

Return Format

The query returns D0, D1, D2, D3, D4, D5, D6, D7, D8, D9, D10, D11, D12, D13, D14, D15, CHAN1, CHAN2, CHAN3, or CHAN4.

Example

```
:TRIGger:SPI:CS CHANnel2 /*Sets the source channel of the CS line
to CHANnel2 when the trigger condition of SPI is set to CS.*/
:TRIGger:SPI:CS? /*The query returns CHAN2.*/
```

3.27.22.10 :TRIGger:SPI:SLEVel

Syntax

```
:TRIGger:SPI:SLEVel <level>
```

```
:TRIGger:SPI:SLEVel?
```

Description

Sets or queries the trigger level of the CS channel of SPI trigger. The unit is the same as that of the current amplitude.

Parameter

Name	Type	Range	Default
<level>	Real	Analog channel: (-4.5 x VerticalScale - OFFSet) to (4.5 x VerticalScale - OFFSet) Digital channel: -20 V to 20 V	0 V

Remarks

- This setting command is valid only when the trigger condition of SPI trigger is CS. You can run the `:TRIGger:SPI:WHEN` command to set or query the trigger condition of SPI trigger.
- For VerticalScale, refer to the `:CHANnel<n>:SCALE` command. For OFFSet, refer to the `:CHANnel<n>:OFFSet` command.
- For the DHO800 series, only the 4-channel model supports CS in SPI trigger.

Return Format

The query returns the trigger level in scientific notation.

Example

```
:TRIGger:SPI:SLEVel 0.16 /*Sets the trigger level to 160 mV.*/
:TRIGger:SPI:SLEVel? /*The query returns 1.600000E-1.*/
```

3.27.22.11 :TRIGger:SPI:MODE**Syntax**

```
:TRIGger:SPI:MODE <mode>
```

```
:TRIGger:SPI:MODE?
```

Description

Sets or queries the CS mode of SPI trigger when the trigger condition is "CS".

Parameter

Name	Type	Range	Default
<mode>	Discrete	{HIGH LOW}	LOW

Remarks

This setting command is only valid in CS mode. You can send `:TRIGger:SPI:WHEN` to set or query the trigger condition of SPI trigger.

For DHO800 series, only 4-channel models support this command.

Return Format

The query returns HIGH or LOW.

Example

```
:TRIGger:SPI:MODE LOW /*Sets the CS mode to LOW.*/
:TRIGger:SPI:MODE? /*The query returns LOW.*/
```

3.27.22.12 :TRIGger:SPI:TIMEout

Syntax

```
:TRIGger:SPI:TIMEout <time>
```

```
:TRIGger:SPI:TIMEout?
```

Description

Sets or queries the timeout value when the trigger condition of SPI trigger is "Timeout". The default unit is s.

Parameter

Name	Type	Range	Default
<time>	Real	16 ns to 1 s	1 μ s

Remarks

This setting command is valid only when the trigger condition of SPI trigger is Timeout. You can run the `:TRIGger:SPI:WHEN` command to set or query the trigger condition of SPI trigger.

Return Format

The query returns the timeout value in scientific notation.

Example

```
:TRIGger:SPI:TIMEout 0.001 /*Sets the timeout value to 1 ms.*/
:TRIGger:SPI:TIMEout? /*The query returns 1.000000E-3.*/
```

3.27.22.13 :TRIGger:SPI:WIDTh

Syntax

```
:TRIGger:SPI:WIDTh <width>
```

```
:TRIGger:SPI:WIDTh?
```

Description

Sets or queries the data width of data channel in SPI trigger.

Parameter

Name	Type	Range	Default
<width>	Integer	4 to 32	8

Remarks

N/A

Return Format

The query returns an integer ranging from 4 to 32.

Example

```
:TRIGger:SPI:WIDTh 10 /*Sets the data width to 10.*/
:TRIGger:SPI:WIDTh? /*The query returns 10.*/
```

3.27.22.14 :TRIGger:SPI:DATA**Syntax**

```
:TRIGger:SPI:DATA <data>
```

```
:TRIGger:SPI:DATA?
```

Description

Sets or queries the data value of SPI trigger.

Parameter

Name	Type	Range	Default
<data>	Integer	0 to $2^{32}-1$	0

Remarks

The range of the parameter <data> is related to the current data width. You can send the *:TRIGger:SPI:WIDTh* command to set or query the data width. The available maximum data width is 32. Therefore, the range of <data> is from 0 to $2^{32}-1$.

Return Format

The query returns an integer.

Example

```
:TRIGger:SPI:DATA 5 /*Sets the data value to 5.*/
:TRIGger:SPI:DATA? /*The query returns 5.*/
```

3.27.22.15 :TRIGger:SPI:CURRbit

Syntax

```
:TRIGger:SPI:CURRbit <currbit>
:TRIGger:SPI:CURRbit?
```

Description

Sets or queries the current bit of the SPI trigger data.

Parameter

Name	Type	Range	Default
<currbit>	Integer	0 to 39	0

Remarks

After configuring the settings for this command, you can send the `:TRIGger:SPI:CODE` command to set or modify the set bit data.

Return Format

The query returns an integer ranging from 0 to 39.

Example

```
:TRIGger:SPI:CURRbit 8 /*Sets the current bit of SPI trigger
data to 8. That is, the oscilloscope triggers on the 9th bit of
SPI trigger data.*/
:TRIGger:SPI:CURRbit? /*The query returns 8.*/
```

3.27.22.16 :TRIGger:SPI:CODE

Syntax

```
:TRIGger:SPI:CODE <code>
:TRIGger:SPI:CODE?
```

Description

Sets or queries the data value of a certain bit of SPI trigger.

Parameter

Name	Type	Range	Default
<code>	Discrete	{0 1 255}	255

Remarks

When <code> is set to 255, it indicates the data value can be any value.

After sending the `:TRIGger:SPI:CURRbit` command to set the specified bit, you can send this command to query or modify the value of the specified data bit.

Return Format

The query returns 0, 1, or 255.

Example

```
:TRIGger:SPI:CODE 0 /*Sets the data value to 0.*/
:TRIGger:SPI:CODE? /*The query returns 0.*/
```

3.27.23 :TRIGger:CAN

The `:TRIGger:CAN` commands are used to set relevant parameters for the CAN trigger.

This oscilloscope can trigger on the start of a frame, end of a frame, frame of the specified type (e.g. Remote, Overload, Data, etc.), or error frame of the specified type (e.g. Answer Error, Check Error, Format Error, etc.) of the CAN signal.

The data frame format of the CAN bus is as shown in the figure below.

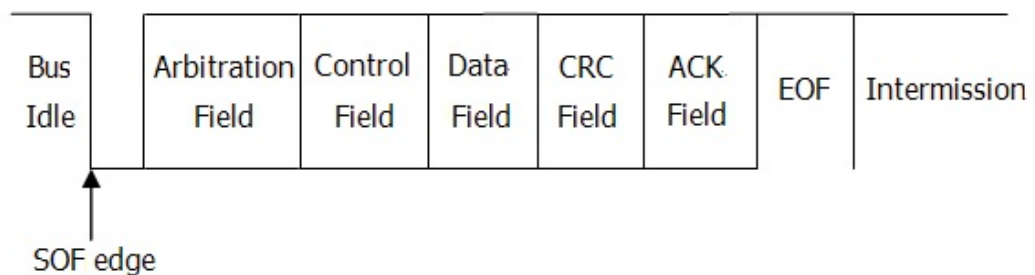

Figure 3.10 Data Frame Format of the CAN Bus

3.27.23.1 :TRIGger:CAN:BAUD

Syntax

```
:TRIGger:CAN:BAUD <baud>
```

```
:TRIGger:CAN:BAUD?
```

Description

Sets or queries the signal rate of CAN trigger. The unit is bps.

Parameter

Name	Type	Range	Default
<baud>	Integer	10 kbps to 5 Mbps	1 Mbps

Remarks

If the baud rate is set to a value with "M", then "A" should be added at the end of the value. For example, if you send 5M, you need to send 5MA.

Return Format

The query returns an integer ranging from 10 kbps to 5 Mbps.

Example

```
:TRIGger:CAN:BAUD 125000 /*Sets the signal rate to 125000 bps.*/
:TRIGger:CAN:BAUD? /*The query returns 125000.*/
```

3.27.23.2 :TRIGger:CAN:SOURce**Syntax**

```
:TRIGger:CAN:SOURce <source>
```

```
:TRIGger:CAN:SOURce?
```

Description

Sets or queries the trigger source of CAN trigger.

Parameter

Name	Type	Range	Default
<source>	Discrete	{D0 D1 D2 D3 D4 D5 D6 D7 D8 D9 D10 D11 D12 D13 D14 D15 CHANnel1 CHANnel2 CHANnel3 CHANnel4}	CHANnel1

Remarks

Digital channels (D0 to D15) are only supported by the DHO900 series.

Return Format

The query returns D0, D1, D2, D3, D4, D5, D6, D7, D8, D9, D10, D11, D12, D13, D14, D15, CHAN1, CHAN2, CHAN3, or CHAN4.

Example

```
:TRIGger:CAN:SOURce CHANnel2 /*Sets the trigger source to
CHANnel2.*/
:TRIGger:CAN:SOURce? /*The query returns CHAN2.*/
```

3.27.23.3 :TRIGger:CAN:STYPe**Syntax**

```
:TRIGger:CAN:STYPe <stype>
```

```
:TRIGger:CAN:STYPe?
```

Description

Sets or queries the signal type of CAN trigger.

Parameter

Name	Type	Range	Default
<stype>	Discrete	{H L RXTX DIFFerential}	H

Remarks

- **H:** indicates the actual CAN_H differential bus signal.
- **L:** indicates the actual CAN_L differential bus signal.
- **RXTX:** indicates the Receive or Transmit signal from the CAN bus transceiver.
- **DIFFerential:** indicates the CAN differential bus signal connected to an analog channel by using a differential probe. Connect the differential probe's positive lead to the CAN_H bus signal and connect the negative lead to the CAN_L bus signal.

Return Format

The query returns H, L, RXTX, or DIFF.

Example

```
:TRIGger:CAN:SType L /*Sets the signal type to CAN_L
differential bus signal.*/
:TRIGger:CAN:SType? /*The query returns L.*/
```

3.27.23.4 :TRIGger:CAN:WHEN**Syntax**

```
:TRIGger:CAN:WHEN <cond>
```

```
:TRIGger:CAN:WHEN?
```

Description

Sets or queries the trigger condition of CAN trigger.

Parameter

Name	Type	Range	Default
<cond>	Discrete	{SOF EOF IDRemote OVERload IDFRame DATAframe IDDData ERFRame ERANswer ERCheck ERFormat ERRandom ERBit}	SOF

Remarks

- **SOF:** indicates start of frame. It indicates that the oscilloscope triggers at the start of a data frame.
- **EOF:** indicates end of frame. It indicates that the oscilloscope triggers at the end of a data frame.

Frame Type

- **IDRemote:** indicates remote ID. It indicates that the oscilloscope triggers on the remote frame with the specified ID.
- **OVERload:** indicates overload frame. It indicates that the oscilloscope triggers on the CAN overload frames.
- **IDFrame:** indicates frame ID. It indicates that the oscilloscope triggers on the data frames with the specified ID.
- **DATAframe:** indicates frame data. It indicates that the oscilloscope triggers on the data frames with specified data.
- **IDData:** indicates Data & ID. It indicates that the oscilloscope triggers on the data frames with the specified ID and data.

Frame Error

- **ERFrame:** indicates frame error. It indicates that the oscilloscope triggers on the error frame.
- **ERANswer:** indicates answer error. It indicates that the oscilloscope triggers on the answer error frame.
- **ERCheck:** indicates check error. It indicates that the oscilloscope triggers on the check error frame.
- **ERFormat:** indicates format error. It indicates that the oscilloscope triggers on the format error frame.
- **ERRandom:** indicates random error. It indicates that the oscilloscope triggers on the random error frame, such as the format error frame, answer error frame, etc.

- **ERBit:** indicates bit fill. It indicates that the oscilloscope triggers on the error frame with the bit fill.

Return Format

The query returns SOF, EOF, IDR, OVER, IDFR, DAT, IDD, ERFR, ERAN, ERCH, ERF, ERR, or ERB.

Example

```
:TRIGger:CAN:WHEN EOF /*Sets the trigger condition to EOF.*/
:TRIGger:CAN:WHEN? /*The query returns EOF.*/
```

3.27.23.5 :TRIGger:CAN:SPOint

Syntax

```
:TRIGger:CAN:SPOint <spoint>
```

```
:TRIGger:CAN:SPOint?
```

Description

Sets or queries the sample point position of CAN trigger (expressed in %).

Parameter

Name	Type	Range	Default
<spoint>	Integer	10 to 90	50

Remarks

The sample point is within the range of the bit time. The oscilloscope samples the bit level at the sample point. The sample point position is expressed as the ratio of "time from the bit start to the sample point" to "bit time", in %.

Return Format

The query returns an integer ranging from 10 to 90.

Example

```
:TRIGger:CAN:SPOint 60 /*Sets the sample point position of
CAN trigger to 60%.*/
:TRIGger:CAN:SPOint? /*The query returns 60.*/
```

3.27.23.6 :TRIGger:CAN:EXTended

Syntax

```
:TRIGger:CAN:EXTended <bool>
```

```
:TRIGger:CAN:EXTended?
```

Description

Enables or disables the extended ID when the trigger condition of CAN trigger is "Remote ID" or "Frame ID"; queries whether the extended ID is enabled when the trigger condition of CAN trigger is "Remote ID" or "Frame ID".

Parameter

Name	Type	Range	Default
<bool>	Bool	{{1 ON}} {0 OFF}}	0 OFF

Remarks

- **0|OFF:** disables the extended ID.
- **1|ON:** enables the extended ID.

To set or query the trigger condition of CAN trigger, send the `:TRIGger:CAN:WHEN` command.

Return Format

The query returns 0 or 1.

Example

```
:TRIGger:CAN:EXTended ON /*Enables the extended ID.*/
:TRIGger:CAN:EXTended /*The query returns 1.*/
```

3.27.23.7 :TRIGger:CAN:DEFine**Syntax**

```
:TRIGger:CAN:DEFine <type>
```

```
:TRIGger:CAN:DEFine?
```

Description

Sets Define to ID or Data when the trigger condition of CAN trigger is set to Data or ID; queries Define to ID or Data when the trigger condition of CAN trigger is set to Data or ID.

Parameter

Name	Type	Range	Default
<type>	Discrete	{DATA ID}	DATA

Remarks

- **DATA:** sets Define to Data.
- **ID:** sets Define to ID.

To set or query the trigger condition of CAN trigger, send the `:TRIGger:CAN:WHEN` command.

Return Format

The query returns DATA or ID.

Example

```
:TRIGger:CAN:DEFine ID /*Sets Define to ID.*/
:TRIGger:CAN:DEFine? /*The query returns ID.*/
```

3.27.23.8 :TRIGger:CAN:DWIDth

Syntax

```
:TRIGger:CAN:DWIDth <data>
```

```
:TRIGger:CAN:DWIDth?
```

Description

Sets or queries the data width of CAN trigger when the trigger condition is "DATAframe" or "IDData".

Parameter

Name	Type	Range	Default
<data>	Integer	1 to 8	1

Remarks

N/A

Return Format

The query returns an integer ranging from 1 to 8.

Example

```
:TRIGger:CAN:DWIDth 5 /*Sets the data width of CAN trigger to 5
when the trigger condition is "DATAframe" or "IDData".*/
:TRIGger:CAN:DWIDth? /*The query returns 5.*/
```

3.27.23.9 :TRIGger:CAN:DATA

Syntax

```
:TRIGger:CAN:DATA <data>
```

```
:TRIGger:CAN:DATA?
```

Description

Sets or queries the data value of CAN trigger.

Parameter

Name	Type	Range	Default
<data>	Integer	0 to 2 ⁴⁰ -1	0

Remarks

The settable range of <data> is affected by the data bytes. You can send the `:TRIGger:IIC:DBYtes` command to set the data bytes. The maximum byte length can be set to 5, i.g. 40-bit binary data. Therefore, the range of <data> is from 0 to 2⁴⁰-1.

This command is valid when the trigger condition is set to "Frame Data" or "Data & ID" (send `:TRIGger:CAN:WHEN` command to set or query).

- When the trigger condition is "Frame Data", the setting command is used to set the data value.
- When the trigger condition is "Data & ID", the value to be set by sending the setting command is based on the `:TRIGger:CAN:DEFine` command.
 - When Define is set to "ID", the setting command is used to set the ID value.
 - When Define is set to "Data", the setting command is used to set the data value.

Return Format

The query returns an integer.

Example

```
:TRIGger:CAN:DATA 100 /*Sets the data value of CAN trigger to
100.*/
:TRIGger:CAN:DATA? /*The query returns 100.*/
```

3.27.23.10 :TRIGger:CAN:CURRbit**Syntax**

```
:TRIGger:CAN:CURRbit <currbit>
```

```
:TRIGger:CAN:CURRbit?
```

Description

Sets or queries the current bit of the CAN trigger data.

Parameter

Name	Type	Range	Default
<currbit>	Integer	0 to 39	0

Remarks

After configuring the settings for this command, you can send the `:TRIGger:CAN:CODE` command to set or modify the set bit data.

Return Format

The query returns an integer ranging from 0 to 39.

Example

```
:TRIGger:CAN:CURRbit 8 /*Sets the current bit of CAN trigger
data to 8. That is, the oscilloscope triggers on the 9th bit of
CAN trigger data.*/
:TRIGger:SPI:CURRbit? /*The query returns 8.*/
```

3.27.23.11 :TRIGger:CAN:CODE**Syntax**

```
:TRIGger:CAN:CODE <code>
```

```
:TRIGger:CAN:CODE?
```

Description

Sets or queries the data value of a certain bit of CAN trigger.

Parameter

Name	Type	Range	Default
<code>	Discrete	{0 1 255}	255

Remarks

When <code> is set to 255, it indicates the data value can be any value.

After sending the `:TRIGger:CAN:CURRbit` command to set the specified bit, you can send this command to query or modify the value of the specified data bit.

Return Format

The query returns 0, 1, or 255.

Example

```
:TRIGger:CAN:CODE 0 /*Sets the data value to 0.*/
:TRIGger:CAN:CODE? /*The query returns 0.*/
```

3.27.23.12 :TRIGger:CAN:LEVel

Syntax

```
:TRIGger:CAN:LEVel <level>
```

```
:TRIGger:CAN:LEVel?
```

Description

Sets or queries the trigger level of CAN trigger. Its unit is the same as that of the current amplitude.

Parameter

Name	Type	Range	Default
<level>	Real	Analog channel: (-4.5 x VerticalScale - Offset) to (4.5 x VerticalScale - Offset) Digital channel: -20 V to 20 V	0 V

Remarks

For VerticalScale, refer to the `:CHANnel<n>:SCALE` command. For OFFSet, refer to the `:CHANnel<n>:OFFSet` command.

Return Format

The query returns the trigger level in scientific notation.

Example

```
:TRIGger:CAN:LEVel 0.16 /*Sets the trigger level to 160 mV.*/
:TRIGger:CAN:LEVel? /*The query returns 1.600000E-1.*/
```

3.27.24 :TRIGger:LIN

The :TRIGger:LIN commands are used to set relevant parameters for the LIN trigger.

NOTE

Only the DHO900 series supports :TRIGger:LIN commands.

The oscilloscope can trigger on the sync field of LIN signal, and can also trigger on the specified identifier, data, or frame.

The data frame format of the LIN bus is as shown in the figure below.

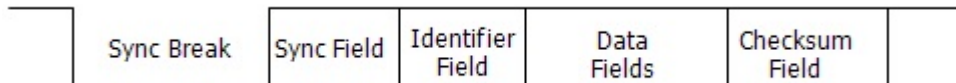

Figure 3.11 Data Frame Format of the LIN Bus

3.27.24.1 :TRIGger:LIN:SOURce

Syntax

```
:TRIGger:LIN:SOURce <source>
```

```
:TRIGger:LIN:SOURce?
```

Description

Sets or queries the trigger source of LIN trigger.

Parameter

Name	Type	Range	Default
<source>	Discrete	{D0 D1 D2 D3 D4 D5 D6 D7 D8 D9 D10 D11 D12 D13 D14 D15 CHANnel1 CHANnel2 CHANnel3 CHANnel4}	CHANnel1

Remarks

Digital channels (D0 to D15) are only supported by the DHO900 series.

Return Format

The query returns D0, D1, D2, D3, D4, D5, D6, D7, D8, D9, D10, D11, D12, D13, D14, D15, CHAN1, CHAN2, CHAN3, or CHAN4.

Example

```
:TRIGger:LIN:SOURce CHANnel2 /*Sets the trigger source to
CHANnel2.*/
:TRIGger:LIN:SOURce? /*The query returns CHAN2.*/
```

3.27.24.2 :TRIGger:LIN:LEVel

Syntax

```
:TRIGger:LIN:LEVel <level>
```

```
:TRIGger:LIN:LEVel?
```

Description

Sets or queries the trigger level of LIN trigger. Its unit is the same as that of the current amplitude.

Parameter

Name	Type	Range	Default
<level>	Real	Analog channel: (-4.5 x VerticalScale - OFFSet) to (4.5 x VerticalScale - OFFSet) Digital channel: -20 V to 20 V	0 V

Remarks

For VerticalScale, refer to the `:CHANnel<n>:SCALE` command. For OFFSet, refer to the `:CHANnel<n>:OFFSet` command.

Return Format

The query returns the trigger level in scientific notation.

Example

```
:TRIGger:LIN:LEVel 0.16 /*Sets the trigger level to 160 mV.*/
:TRIGger:LIN:LEVel? /*The query returns 1.600000E-1.*/
```

3.27.24.3 :TRIGger:LIN:STANdard**Syntax**

```
:TRIGger:LIN:STANdard <std>
```

```
:TRIGger:LIN:STANdard?
```

Description

Sets or queries the protocol version of LIN trigger.

Parameter

Name	Type	Range	Default
<std>	Discrete	{1X 2X BOTH}	BOTH

Remarks

N/A

Return Format

The query returns 1X, 2X, or BOTH.

Example

```
:TRIGger:LIN:STANdard 2X /*Sets the protocol version of
LIN trigger to 2X.*/
:TRIGger:LIN:STANdard? /*The query returns 2X.*/
```

3.27.24.4 :TRIGger:LIN:BAUD

Syntax

```
:TRIGger:LIN:BAUD <baud>
```

```
:TRIGger:LIN:BAUD?
```

Description

Sets or queries the baud rate of LIN trigger. The default unit is bps.

Parameter

Name	Type	Range	Default
<baud>	Integer	1 kbps to 20 Mbps	9600 bps

Remarks

If the baud rate is set to a value with "M", then "A" should be added at the end of the value. For example, if you send 5M, you need to send 5MA.

Return Format

The query returns an integer ranging from 1 kbps to 20 Mbps.

Example

```
:TRIGger:LIN:BAUD 19200 /*Sets the baud rate of LIN trigger
to 19.2 kbps.*/
:TRIGger:LIN:BAUD? /*The query returns 19200.*/
```

3.27.24.5 :TRIGger:LIN:SAMPlepoint

Syntax

```
:TRIGger:LIN:SAMPlepoint <value>
```

```
:TRIGger:LIN:SAMPlepoint?
```

Description

Sets or queries the sample position of LIN trigger.

Parameter

Name	Type	Range	Default
<value>	Integer	10 to 90	50

Remarks

The sample position is expressed as the ratio of "time from the bit start to the sample point" to "bit time", in %.

Return Format

The query returns an integer ranging from 10 to 90.

Example

```
:TRIGger:LIN:SAMplepoint 40          /*Sets the sample point
position of LIN trigger to 40%.*/*
:TRIGger:LIN:SAMplepoint?          /*The query returns 40.*/*
```

3.27.24.6 :TRIGger:LIN:WHEN**Syntax**

```
:TRIGger:LIN:WHEN <when>
```

```
:TRIGger:LIN:WHEN?
```

Description

Sets or queries the trigger condition of LIN trigger.

Parameter

Name	Type	Range	Default
<when>	Discrete	{SYNCbreak ID DATA IDData SLEep WAKEup ERRor}	SYNCbreak

Remarks

- **SYNCbreak:** triggers on the last bit of the sync field.
- **ID:** triggers when the frames with the specified ID are found.
- **DATA:** triggers when the data that meet the preset conditions are found.
- **IDData:** triggers when the frames with the specified ID and data that meet the preset conditions are both found.
- **SLEep:** triggers when the sleep frame is found.
- **WAKEup:** triggers when the wakeup frame is found.
- **ERRor:** triggers on the specified type of error frame.

Return Format

The query returns SYNC, ID, DATA, IDD, SLE, WAK, or ERR.

Example

```
:TRIGger:LIN:WHEN SYNCbreak          /*Sets the trigger condition to
SYNCbreak.*/*
:TRIGger:LIN:WHEN?                  /*The query returns SYNC.*/*
```

3.27.24.7 :TRIGger:LIN:ERRor

Syntax

```
:TRIGger:LIN:ERRor <value>
```

```
:TRIGger:LIN:ERRor?
```

Description

Sets or queries the error type of LIN trigger when the trigger condition is "Data".

Parameter

Name	Type	Range	Default
<value>	Discrete	{SYNC ID CHECK}	SYNC

Remarks

- **SYNC:** indicates Sync error.
- **ID:** indicates Even Odd error.
- **CHECK:** check sum error.

Return Format

The query returns SYNC, ID, or CHEC.

Example

```
:TRIGger:LIN:ERRor ID          /*Sets the LIN trigger error type to
ID.*/
:TRIGger:LIN:ERRor?           /*The query returns ID.*/
```

3.27.24.8 :TRIGger:LIN:ID

Syntax

```
:TRIGger:LIN:ID <id>
```

```
:TRIGger:LIN:ID?
```

Description

Sets or queries the ID value of LIN trigger when the trigger condition is "Data & ID".

Parameter

Name	Type	Range	Default
<id>	Integer	0 to 63	0

Remarks

N/A

Return Format

The query returns an integer ranging from 0 to 63.

Example

```
:TRIGger:LIN:ID 4 /*Sets the ID value of LIN trigger
to 4.*/*
:TRIGger:LIN:ID? /*The query returns 4.*/*
```

3.27.24.9 :TRIGger:LIN:DATA**Syntax**

```
:TRIGger:LIN:DATA <data>
```

```
:TRIGger:LIN:DATA?
```

Description

Sets or queries the data value of LIN trigger when the trigger condition is "Data".

Parameter

Name	Type	Range	Default
<data>	Integer	Refer to <i>Remarks</i>	0

Remarks

The range of the data value of LIN trigger is related to the value of data bytes. The maximum number of bytes can be set to 8, i.g. 64-bit binary data. Therefore, the range of <data> is from 0 to $2^{64}-1$.

Return Format

The query returns an integer ranging from 0 to $2^{64}-1$.

Example

```
:TRIGger:LIN:DATA 100 /*Sets the data value of LIN trigger to
100 when the trigger condition is "Data".*/
:TRIGger:LIN:DATA? /*The query returns 100.*/*
```

3.27.24.10 :TRIGger:LIN:CURREbit**Syntax**

```
:TRIGger:LIN:CURREbit <currbit>
```

```
:TRIGger:LIN:CURREbit?
```

Description

Sets or queries the current bit of the LIN trigger data.

Parameter

Name	Type	Range	Default
<currbit>	Integer	0 to 39	0

Remarks

After configuring the settings for this command, you can send the `:TRIGger:LIN:CODE` command to set or modify the set bit data.

Return Format

The query returns an integer ranging from 0 to 39.

Example

```
:TRIGger:LIN:CURRbit 8 /*Sets the current bit of LIN trigger
data to 8. That is, the oscilloscope triggers on the 9th bit of
LIN trigger data.*/
:TRIGger:SPI:CURRbit? /*The query returns 8.*/
```

3.27.24.11 :TRIGger:LIN:CODE**Syntax**

```
:TRIGger:LIN:CODE <code>
```

```
:TRIGger:LIN:CODE?
```

Description

Sets or queries the data value of a certain bit of LIN trigger.

Parameter

Name	Type	Range	Default
<code>	Discrete	{0 1 255}	255

Remarks

When <code> is set to 255, it indicates the data value can be any value.

After sending the `:TRIGger:LIN:CURRbit` command to set the specified bit, you can send this command to query or modify the value of the specified data bit.

Return Format

The query returns 0, 1, or 255.

Example

```
:TRIGger:LIN:CODE 0 /*Sets the data value to 0.*/
:TRIGger:LIN:CODE? /*The query returns 0.*/
```

3.28 :WAVEform Commands

The **:WAVEform** commands are used to read waveform data and relevant settings. The **:WAVEform:MODE** command is used to set the reading mode of waveform data. In different modes, the definitions for the parameters are different, as shown in [Figure 3.12](#) and [Figure 3.13](#).

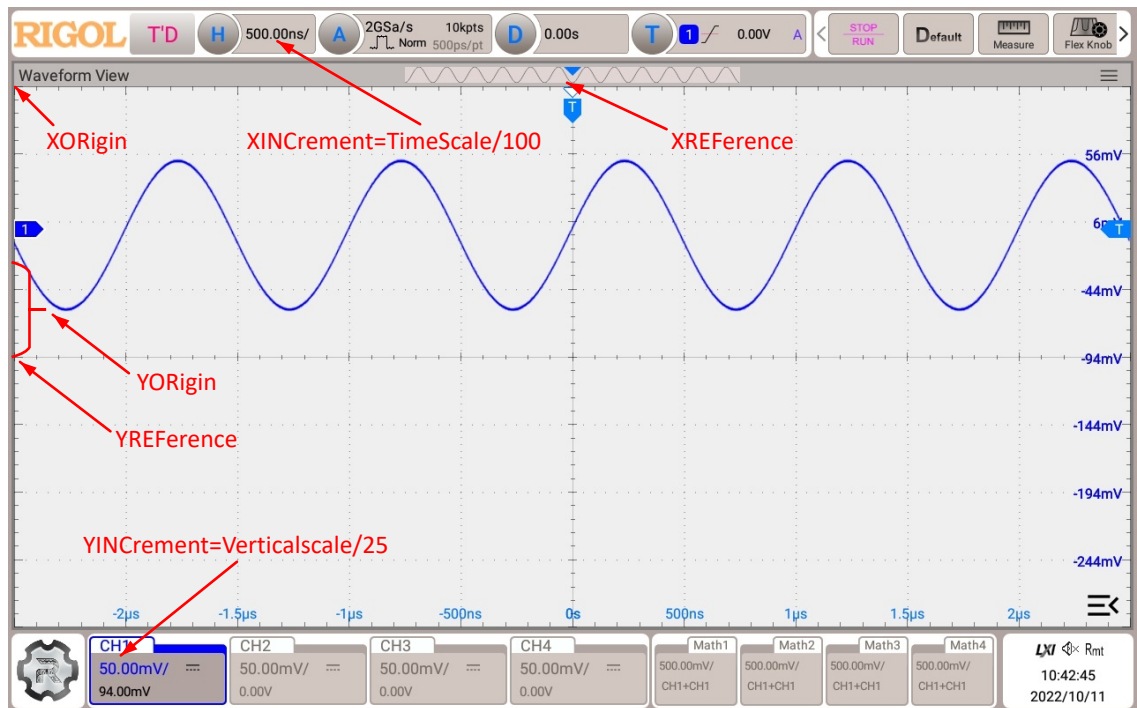

Figure 3.12 Parameter Definitions in NORMAL Mode

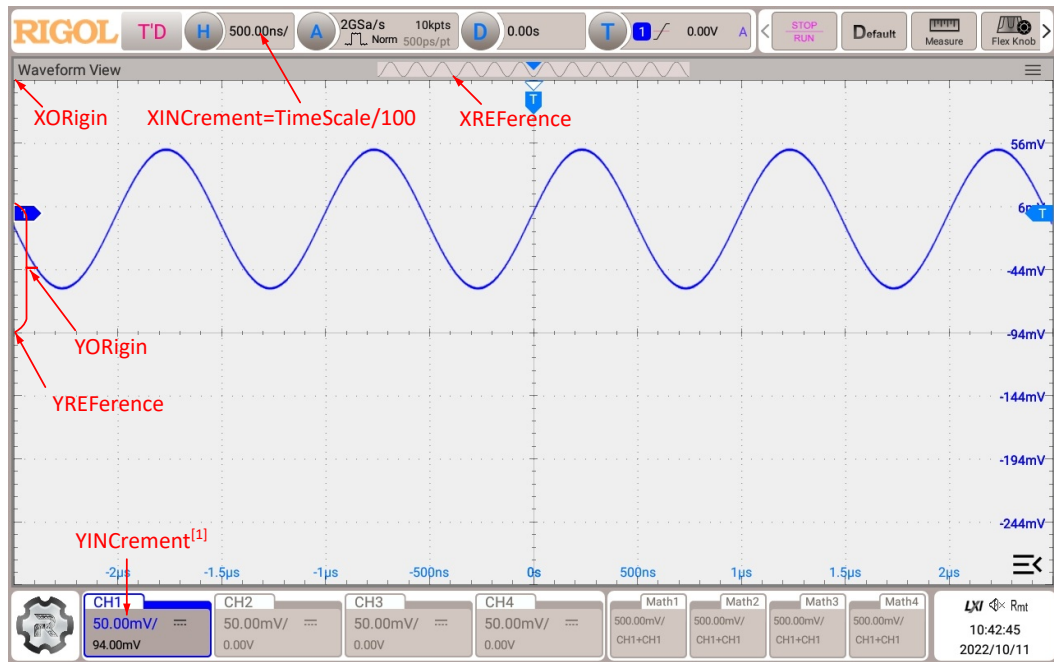

Figure 3.13 Parameter Definitions in RAW Mode

NOTE

[1]: In RAW mode, YINcrement and Verticalscale of the memory waveforms are related to the currently selected Verticalscale.

Waveform data reading

- WORD or BYTE format:** The read data format is TMC header + waveform data points + end identifier. The TMC header is in #NXXXXXX format; wherein, # is the TMC header identifier; N following # represents the length of the waveform data; the length of the waveform data points is expressed in ASCII strings, and the terminator represents the ending of communication. For example, the data read for one time is #9000001000XXXX. It indicates that 9 bytes are used to describe the data length. 000001000 indicates the length of waveform data, that is, 1,000 bytes.
- AScii format:** The read data format is waveform data points + end identifier. The waveform data point query returns the actual voltage value of each waveform point in scientific notation; and the voltage values are separated by commas.

- When the waveform data in the internal memory are read in batches, the waveform data returned each time might be the data in one area of the internal memory. In "WORD" or "BYTE" return format, each returned data in blocks contain the TMC data block header. Waveform data in two adjacent data blocks are consecutive.
- The figure below shows the waveform data that have been read (in BYTE format). First, select "View as hexadecimal only" from the drop-down list at the right side. Then, the waveform data that have been read are displayed in hexadecimal format. The first 11 bytes denote the "TMC data block header", and beginning from the 12th byte (8E) are the waveform data. You can convert the waveform data read to the voltage value of each point of the waveform by using the formula " $(0x8E - YORigin - YREference) \times YINCrement$ ". For the definitions of the parameters in this formula, refer to *Related Commands*.

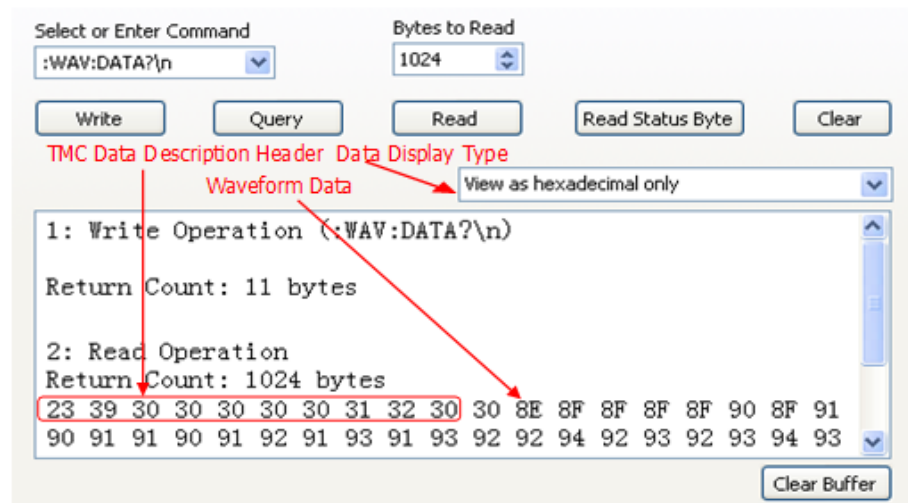

Related Commands

:WAVeform:MODE

:WAVeform:YINCrement?

:WAVeform:YORigin?

3.28.1 :WAVeform:SOURce

Syntax

:WAVeform:SOURce <source>

:WAVeform:SOURce?

Description

Sets or queries the source channel of waveform data reading.

Parameter

Name	Type	Range	Default
<source>	Discrete	{D0 D1 D2 D3 D4 D5 D6 D7 D8 D9 D10 D11 D12 D13 D14 D15 CHANnel1 CHANnel2 CHANnel3 CHANnel4 MATH1 MATH2 MATH3 MATH4}	CHANnel1

Remarks

When the channel source is set to MATH1~MATH4, *:WAVeform:MODE* can only select the NORMAl mode.

D0~D15 are only available for the DHO900 series.

Return Format

The query returns D0, D1, D2, D3, D4, D5, D6, D7, D8, D9, D10, D11, D12, D13, D14, D15, CHAN1, CHAN2, CHAN3, CHAN4, MATH1, MATH2, MATH3, or MATH4.

Example

```
:WAVeform:SOURce CHANnel2 /*Sets the channel source to
CHANnel2.*/
:WAVeform:SOURce? /*The query returns CHAN2.*/
```

3.28.2 :WAVeform:MODE

Syntax

:WAVeform:MODE <mode>

:WAVeform:MODE?

Description

Sets or queries the mode of the *:WAVeform:DATA?* command in reading data.

Parameter

Name	Type	Range	Default
<mode>	Discrete	{NORMAl MAXimum RAW}	NORMAl

Remarks

- **NORMAl:** reads the waveform data currently displayed on the screen.

- **MAXimum:** reads the waveform data displayed on the screen when the oscilloscope is in the Run state; reads the waveform data from the internal memory when the oscilloscope is in the Stop state.
- **RAW:** reads the waveform data from the internal memory. Note: The data in the internal memory can only be read when the oscilloscope is in the Stop state. You are not allowed to operate the instrument when it is reading data.
- When the channel source is set to MATH, only the NORMal mode is valid.

Return Format

The query returns NORM, MAX, or RAW.

Example

```
:WAVeform:MODE RAW /*Sets the reading mode of waveform data to
RAW.*/*
:WAVeform:MODE? /*The query returns RAW.*/*
```

3.28.3 :WAVeform:FORMat

Syntax

```
:WAVeform:FORMat <format>
```

```
:WAVeform:FORMat?
```

Description

Sets or queries the return format of the waveform data.

Parameter

Name	Type	Range	Default
<format>	Discrete	{WORD BYTE ASCii}	BYTE

Remarks

- **WORD:** Each waveform point occupies two bytes (16 bits).
- **BYTE:** Each waveform point occupies one byte (8 bits).
- **ASCii:** The query returns the actual voltage value of each waveform point in scientific notation; and the voltage values are separated by commas.

Return Format

The query returns WORD, BYTE, or ASC.

Example

```
:WAVeform:FORMat WORD /*Sets the returned format of waveform data
to WORD.*/*
:WAVeform:FORMat? /*The query returns WORD.*/*
```

3.28.4 :WAVeform:POINTs

Syntax

```
:WAVeform:POINTs <point>
```

```
:WAVeform:POINTs?
```

Description

Sets or queries the number of the waveform points to be read in the current mode.

Parameter

Name	Type	Range	Default
<point>	Integer	Refer to <i>Remarks</i>	-

Remarks

The range of <point> is related to the current reading mode of the waveform data. You can send the *:WAVeform:MODE* command to set or query the reading mode of the waveform data.

- **NORMAL:** 1 to 1,000
- **RAW:** 1 to the current maximum memory depth
- **MAXimum:** In RUN state: 1 to the number of effective points on the current screen; In STOP state: 1 to the number of effective points in the current memory

Return Format

The query returns the number of waveform points in integer.

Example

```
:WAVeform:POINTs 100 /*Sets the number of waveform points to be
read to 100.*/
:WAVeform:POINTs? /*The query returns 100.*/
```

3.28.5 :WAVeform:DATA?

Syntax

```
:WAVeform:DATA?
```

Description

Reads the waveform data.

Parameter

N/A

Remarks

Procedures of reading the waveform data from the screen:

```

:WAV:SOUR CHAN1 /*Sets the channel source to CHANnel1.*/
:WAV:MODE NORMAl /*Sets the waveform reading mode to NORMAl.*/
:WAV:FORM BYTE /*Sets the return format of the waveform data to
BYTE.*/
:WAV:DATA? /*Reads the waveform data on the screen.*/

```

Procedures of reading the waveform data from the internal memory:

```

:STOP /*Sets the instrument to STOP state (you can only read the
waveform data from the internal memory when the oscilloscope is in
STOP state).*/
:WAV:SOUR CHAN1 /*Sets the channel source to CHANnel1.*/
:WAV:MODE RAW /*Sets the waveform reading mode to RAW.*/
:WAV:FORM BYTE /*Sets the return format of the waveform data to
BYTE.*/
:WAV:STAR 1 /*Sets the start point of waveform data reading to
the first waveform point.*/
:WAVeform:STOP 120000 /*Sets the stop point of waveform data
reading to the 120,000th waveform point (last point).*/

```

Return Format

The return format is related to the return format of the currently selected waveform data (:WAVeform:FORMat). For detailed operations, refer to descriptions in [Waveform data reading](#).

3.28.6 :WAVeform:XINCrement?

Syntax

```
:WAVeform:XINCrement?
```

Description

Queries the time interval between two neighboring points of the currently selected channel source in the X direction.

Parameter

N/A

Remarks

The returned value is related to the current data reading mode:

- In NORMAl mode, XINCrement = TimeScale/100.
- In RAW mode, XINCrement = 1/SampleRate.
- In MAX mode, XINCrement = TimeScale/100 when the oscilloscope is in the Run state; XINCrement = 1/SampleRate when the oscilloscope is in the Stop state.

The unit is related to the current channel source:

Return Format

The query returns the time difference in scientific notation.

Example

N/A

3.28.7 :WAVeform:XORigin?

Syntax`:WAVeform:XORigin?`**Description**

Queries the start time of the waveform data of the currently selected channel source in the X direction.

Parameter

N/A

Remarks

The returned value is related to the current data reading mode:

- In NORMAL mode, the query returns the start time of the waveform data displayed on the screen.
- In RAW mode, the query returns the start time of the waveform data in the internal memory.
- In MAX mode, the query returns the start time of the waveform data displayed on the screen when the instrument is in the RUN state; the query returns the start time of the waveform data in the internal memory when the instrument is in the Stop state.

The unit is related to the current channel source.

Return Format

The query returns the time value in scientific notation.

Example

N/A

3.28.8 :WAVeform:XREFerence?

Syntax`:WAVeform:XREFerence?`**Description**

Queries the reference time of the waveform points of the currently selected channel source in the X direction.

Parameter

N/A

Remarks

N/A

Return Format

The query returns 0 (namely the first waveform point on the screen or in the internal memory).

Example

N/A

3.28.9 :WAVeform:YINCrement?

Syntax

:WAVeform:YINCrement?

Description

Queries the unit voltage value of the current source channel Y in the Y direction.

Parameter

N/A

Remarks

The returned value is related to the current data reading mode:

- In NORMAL mode, YINCrement = VerticalScale/25.
- In RAW mode, YINCrement and Verticalscale of the memory waveforms are related to the currently selected Verticalscale.
- In MAX mode, YINCrement = VerticalScale/25 when the instrument is in the RUN state; YINCrement is related to the VerticalScale of the internal waveform and the currently selected VerticalScale when the instrument is in the Stop state.

Return Format

The query returns the unit voltage value in scientific notation.

Example

N/A

3.28.10 :WAVeform:YORigin?

Syntax

:WAVeform:YORigin?

Description

Queries the vertical offset relative to the vertical reference position of the currently selected channel source in the Y direction.

Parameter

N/A

Remarks

The returned value is related to the current data reading mode:

- In NORMAL mode, YORigin = VerticalOffset/YINcrement.
- In RAW mode, YORigin is related to the VerticalScale of the memory waveforms and the currently selected VerticalScale.
- In MAX mode, YORigin = VerticalOffset/YINcrement when the instrument is in the RUN state; YORigin is related to the VerticalScale of the internal waveform and the currently selected VerticalScale when the instrument is in the Stop state.

Return Format

The query returns an integer.

Example

N/A

3.28.11 :WAVeform:YREFerence?

Syntax

:WAVeform:YREFerence?

Description

Queries the vertical reference position of the currently selected channel source in the Y direction.

Parameter

N/A

Remarks

The value of YREference is related to the configuration of the `:WAVeform:FORMat` command. The reference position is different for different return formats of waveform data.

Return Format

The query returns an integer.

Example

N/A

3.28.12 :WAVeform:START**Syntax**

```
:WAVeform:START <sta>
```

```
:WAVeform:START?
```

Description

Sets or queries the start position of waveform data reading.

Parameter

Name	Type	Range	Default
<sta>	Integer	Refer to <i>Remarks</i>	1

Remarks

When reading the waveform data from the internal memory, the actual settable ranges of the start point and stop point of a reading operation are related to the memory depth of the oscilloscope and the return format of the waveform data currently selected.

- In Normal mode, the range is from 1 to 1,000.
- In Max mode, when the oscilloscope is in RUN state, its range is from 1 to 1,000; when the oscilloscope is in STOP state, its range is from 1 to current maximum memory depth.
- In Raw mode, the range is from 1 to the current maximum memory depth.

Return Format

The query returns an integer.

Example

```
:WAVeform:START 100 /*Sets the start point to 100.*/
:WAVeform:START? /*The query returns 100.*/
```

3.28.13 :WAVeform:STOP

Syntax

```
:WAVeform:STOP <stop>
```

```
:WAVeform:STOP?
```

Description

Sets or queries the stop position of waveform data reading.

Parameter

Name	Type	Range	Default
<stop>	Integer	Refer to <i>Remarks</i>	1,000

Remarks

When reading the waveform data in the internal memory, the actual settable ranges of the start point and stop point of a reading operation are related to the memory depth of the oscilloscope and the return format of the waveform data currently selected.

- In Normal mode, the range is from 1 to 1,000.
- In Max mode, when the oscilloscope is in RUN state, its range is from 1 to 1,000; when the oscilloscope is in STOP state, its range is from 1 to current maximum memory depth.
- In Raw mode, the range is from 1 to the current maximum memory depth.

Return Format

The query returns an integer.

Example

```
:WAVeform:STOP 500 /*Sets the stop point to 500.*/
:WAVeform:STOP? /*The query returns 500.*/
```

3.28.14 :WAVeform:PREamble?

Syntax

```
:WAVeform:PREamble?
```

Description

Queries all the waveform parameters.

Parameter

N/A

Remarks

N/A

Return Format

The query returns 10 waveform parameters, separated by commas.

<format>, <type>, <points>, <count>, <xincrement>, <xorigin>, <xreference>, <yincrement>, <yorigin>, <yreference>

Wherein,

<**format**>: indicates 0 (BYTE), 1 (WORD), or 2 (ASC).

<**type**>: indicates 0 (NORMAL), 1 (MAXimum), or 2 (RAW).

<**points**>: an integer ranging from 1 to 50,000,000.

<**count**>: indicates the number of averages in the average sample mode. The value of <count> parameter is 1 in other modes.

<**xincrement**>: indicates the time difference between two neighboring points in the X direction.

<**xorigin**>: indicates the start time of the waveform data in the X direction.

<**xreference**>: indicates the reference time of the waveform data in the X direction.

<**yincrement**>: indicates the step value of the waveforms in the Y direction.

<**yorigin**>: indicates the vertical offset relative to the "Vertical Reference Position" in the Y direction.

<**yreference**>: indicates the vertical reference position in the Y direction.

Example

```
:WAVEform:PREamble?/*The query returns
0,0,1000,1,1.000000E-8,-5.000000E-6,0.000000E-12,4.000000E-03,0,128.
*/
```

4 Application Examples

This chapter provides some application examples of the SCPI commands. The main functions of the instrument can be realized through a series of SCPI commands.



NOTE

- The range of certain parameters for different models may be different. Therefore, you need to adjust the parameter range for the model that you use if necessary.
- Before using the examples in this chapter, please select the desired communication interface (USB or LAN) and make correct connections. In addition, you have to install Ultra Sigma or other PC software that can be used to send commands.
- In each example, every command is followed by contents enclosed by two slashes ("/*" and "*/"). They are the descriptions of the command and not part of the command, which help you understand the command better.

4.1 To Configure Basic Parameters

Set the Channel Parameters

Example description: enable CH1, set the vertical scale to 0.1 V/div, and set the coupling mode to AC.

Method

```
:CHANnel1:DISPlay ON      /*Enables CHANnel1.*/
:CHANnel1:SCALe 0.1      /*Sets the vertical scale to 0.1 V/div
for CH1.*/
:CHANnel1:COUPling AC    /*Sets the coupling mode to AC for CH1.*/
```

Set the Horizontal Parameters

Example description: set the memory depth to 1M and the horizontal time base to 200 μ s/div.

Method

```
:ACQuire:MDEPth 1M      /*Sets the memory depth to 1M.*/
:TIMEbase:MODE MAIN     /*Sets the horizontal time base mode
to MAIN.*/
:TIMEbase:MAIN:SCALe 0.0002 /*Sets the main time base to 200  $\mu$ s/
div.*/
```

Set the Trigger Parameters

Example description: set the triggers on the rising edge with the specified voltage threshold (160 mV).

Method

```
:TRIGger:MODE EDGE     /*Selects the edge trigger.*/
:TRIGger:EDGE:SOURce CHANnel2 /*Sets the trigger source to
```

```

CHANnel2.*/  

:TRIGger:EDGE:SLOPe POSitive /*Sets the edge type to rising  

edge.*/  

:TRIGger:EDGE:LEVel 0.16 /*Sets the trigger level to 160  

mV.*/  

:TRIGger:STATus? /*Queries the current trigger  

status.*/  

```

4.2 To Set Measurements

Read the Statistical Peak-to-Peak Value

Example description: reads the statistical peak-to-peak value for CH2.

Method

```

:MEASure:THReshold:TYPE PERCent /*Sets the threshold type to  

PERCent.*/  

:MEASure:SETup:MAX 95 /*Sets the upper limit to 95%.*/  

:MEASure:SETup:MID 89 /*Sets the middle value to 89%.*/  

:MEASure:SETup:MIN 53 /*Sets the lower limit to 53%.*/  

:MEASure:ITEM VPP,CHANnel2 /*Adds the CH2 waveform peak-to-peak  

value measurement item./  

:MEASure:ITEM? VPP,CHANnel2 /*Queries the current measurement  

results of the CH2 waveform peak-to-peak value.*/  

:MEASure:STATistic:RESet /*Clears the history  

statistics data and makes statistics again.*/  

:MEASure:STATistic:ITEM VPP,CHANnel2  

/*Adds the CH2 waveform peak-to-peak value measurement  

item.*/  

:MEASure:STATistic:ITEM? CNT,VPP,CHANnel2  

/*Queries the count value of the measurement item. */  

:MEASure:STATistic:ITEM? MAXimum,VPP,CHANnel2  

/*Queries the maximum value of the CH2 peak-to-peak  

value.*/  

:MEASure:STATistic:ITEM? MINimum,VPP,CHANnel2  

/*Queries the minimum value of the CH2 peak-to-peak  

value.*/  

:MEASure:STATistic:ITEM? AVERages,VPP,CHANnel2  

/*Queries the average value of the CH2 peak-to-peak  

value.*/  

:MEASure:STATistic:ITEM? DEVIation,VPP,CHANnel2  

/*Queries the deviation of the CH2 peak-to-peak value.*/  

```

Read the Duty Cycle

Example description: read the duty cycle of the periodic pulse at a set percentage.

Method

```

:MEASure:THReshold:TYPE PERCent /*Sets the threshold type to  

PERCent.*/  

:MEASure:SETup:MAX 95 /*Sets the upper limit to 95%.*/  

:MEASure:SETup:MID 89 /*Sets the middle value to 89%.*/  

:MEASure:SETup:MIN 53 /*Sets the lower limit to 53%.*/  

:MEASure:ITEM PDUTy,CHANnel2 /*Adds the CH2 periodic pulse duty  

cycle measurement item.*/  

```

```
:MEASure:ITEM? PDUTy,CHANnel2 /*Queries the current duty cycle
value for CH2.*/
```

```
:MEASure:STATistic:RESet /*Clears the history statistics data and
makes statistics again.*/
:MEASure:STATistic:ITEM PDUTy,CHANnel2 /*Adds the CH2 waveform duty
cycle measurement item.*/
```

```
:MEASure:STATistic:ITEM? CNT,PDUTy,CHANnel2
/*Queries the count value of the measurement item. */
:MEASure:STATistic:ITEM? MAXimum,PDUTy,CHANnel2
/*Queries the maximum value of the CH2 duty cycle.*/
:MEASure:STATistic:ITEM? MINimum,PDUTy,CHANnel2
/*Queries the minimum value of the CH2 duty cycle.*/
:MEASure:STATistic:ITEM? AVERages,PDUTy,CHANnel2
/*Queries the average value of the CH2 duty cycle.*/
:MEASure:STATistic:ITEM? DEVIation,PDUTy,CHANnel2
/*Queries the deviation of the CH2 duty cycle value.*/
```

Read the Rise Time

Example description: read the rise time using the set voltage threshold.

Method

```
:MEASure:THReshold:TYPE ABSolute /*Sets the threshold type to
ABSolute.*/
:MEASure:SETup:MAX 0.15 /*Sets the threshold level upper
limit to 0.15 V.*/
:MEASure:SETup:MID 0 /*Sets the threshold level middle
value to 0 V.*/
:MEASure:SETup:MIN -0.15 /*Sets the threshold level lower
limit to -0.15 V.*/
```

```
:MEASure:ITEM RTIME,CHANnel2 /*Adds the CH2 rise time
measurement item.*/
:MEASure:STATistic:ITEM? CURRent,RTIME /*Queries the current
measurement value of the CH2 rise time.*/
```

```
:MEASure:STATistic:RESet /*Clears the history
statistics data and makes statistics again.*/
:MEASure:STATistic:ITEM RTIME,CHANnel2 /*Enables the CH2 rise time
statistic function.*/
:MEASure:STATistic:ITEM? CURRent,RTIME /*Queries the current value
of the CH2 rise time.*/
```

```
:MEASure:STATistic:ITEM? CNT,RTIME,CHANnel2
/*Queries the count value of the measurement item. */
:MEASure:STATistic:ITEM? MAXimum,RTIME,CHANnel2
/*Queries the maximum value of the CH2 rise time.*/
:MEASure:STATistic:ITEM? MINimum,RTIME,CHANnel2
/*Queries the minimum value of the CH2 rise time.*/
:MEASure:STATistic:ITEM? AVERages,RTIME,CHANnel2
/*Queries the average value of the CH2 rise time.*/
:MEASure:STATistic:ITEM? DEVIation,RTIME,CHANnel2
/*Queries the deviation of the CH2 rise time.*/
```

4.3 To Read the Waveform

Read ASCII Data

Example description: read ASCII data and transform the data to actual waveform data.

Method

```
:ACQuire:MDEPth 100k /*Sets the memory depth to 100k.*/
:RUN /*Sets the oscilloscope to "RUN" state and wait for 5
s.*/
:STOP /*Sets the oscilloscope to "STOP" state (the
oscilloscope can only read the waveform data in internal memory
when in "STOP" state).*/

:WAV:SOUR CHAN1 /*Sets the channel source to CHANnel1.*/
:WAV:MODE RAW /*Sets the waveform reading mode to RAW.*/
:WAV:FORM ASCii /*Sets the return format of the waveform data
to ASCii.*/

:WAV:STAR 1 /*Sets the start point to read from to the 1st
point.*/
:WAV:STOP 100000 /*Sets the stop point to the 100,000th point
(the last point).*/
:WAV:DATA? /*Reads the waveform data.*/
:WAVeform:PREamble? /*The query returns all waveform parameters.*/
```

Read the Waveform Data in Internal Memory

Example description: reads the waveform data from the internal memory.

Method

```
:ACQuire:MDEPth 100k /*Sets the memory depth to 100k.*/
:RUN /*Sets the oscilloscope to "RUN" state and wait for 5 s.*/
:STOP /*Set the oscilloscope to "STOP" state (the oscilloscope
can only read the waveform data in internal memory when in "STOP"
state).*/

:WAV:SOUR CHAN1 /*Sets the channel source to CHANnel1.*/
:WAV:MODE RAW /*Sets the waveform reading mode to RAW.*/
:WAV:FORM BYTE /*Sets the return format of the waveform
data to BYTE.*/
:WAV:STAR 1 /*Sets the start point to read from to the
1st waveform.*/
:WAVeform:STOP 100000 /*Sets the stop point to the 100,000th point
(the last point).*/
:WAV:DATA? /*Reads the waveform data.*/
```

Read the Waveform Data on the Screen

Example description: reads the waveform data on the display.

Method

```
:WAV:SOUR CHAN1 /*Sets the channel source to CHANnel1.*/
:WAV:MODE NORMal /*Sets the waveform reading mode to NORMal.*/
:WAV:FORM BYTE /*Sets the return format of the waveform data
to BYTE.*/
:WAV:DATA? /*Reads the waveform data on the screen.*/
```

5 Programming Examples

This chapter illustrates how to control the instrument by programming in LabVIEW, Visual Basic, and Visual C++. These examples are programmed based on Virtual Instrument Software Architecture (VISA) library.

RIGOL official website (<http://www.rigol.com>) provides the programming examples based on LabVIEWk, Visual Basic, Visual C++, Matlab, and Python. You can go to the official website and click **SUPPORT** > **Programming Demo** to obtain the programming examples.

5.1 Programming Preparations

Before programming, you need to prepare the following tasks:

You can log in to the RIGOL official website (<http://www.rigol.com>) to download the software. Then install the software according to the installation wizard. After Ultra Sigma is installed successfully, NI-VISA library will be completely installed automatically. In this manual, the default installation path is C:\Program Files\IVI Foundation\VISA.

In the manual, the instrument communicates with the PC via the USB interface. Connect the USB Device interface on the rear panel of the instrument to the PC by using the USB cable. After the instrument is properly connected to the PC, power on the instrument to start it.

The following parts will make a detailed introduction about the programming examples in LabVIEW, Visual Basic, and Visual C++.

5.2 LabVIEW Programming Example

Program used in this example: LabVIEW2010

Function realized in this example: reading the waveform data of CH1 on the screen.

1. Run LabVIEW, and then create a VI file named LabVIEW_Demo.
2. Add controls and create the front panel as shown in the figure below.

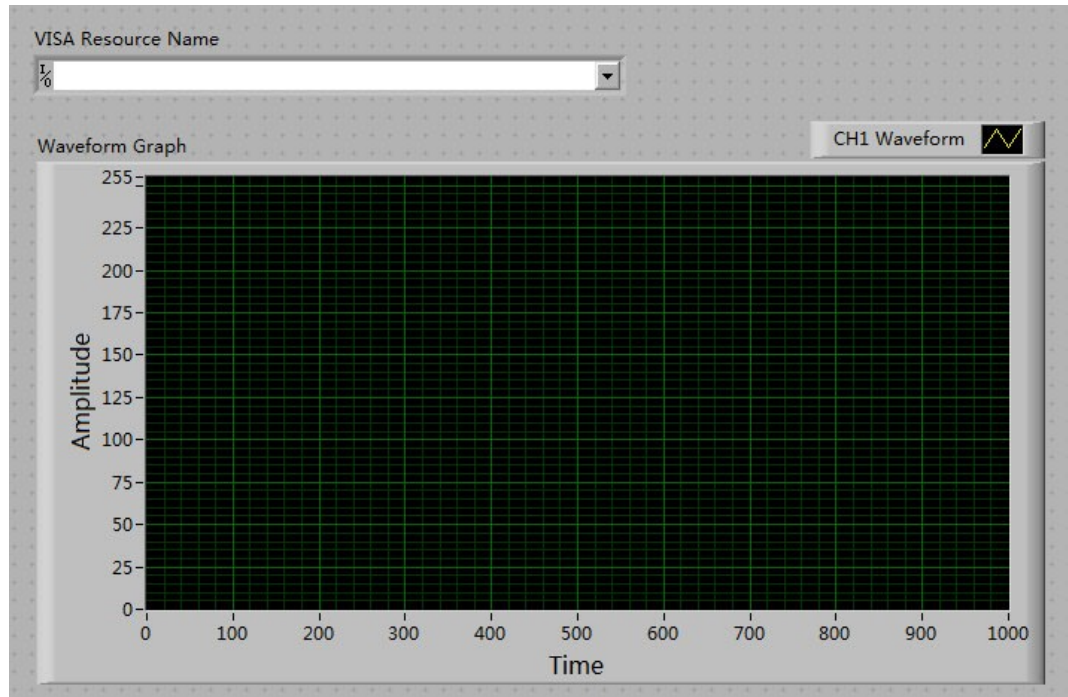

3. Open the Block Diagram panel. Click **Instrument I/O** > **VISA**. Add the following functions: VISA Open, VISA Read, VISA Write, and VISA Close.

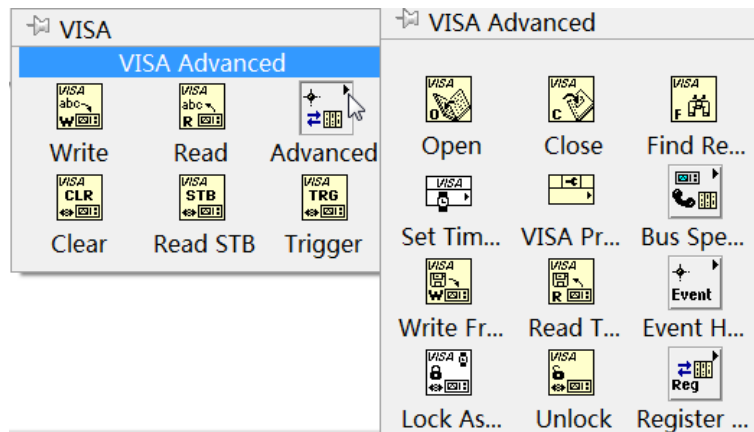

4. Connect the VISA resource name with the VISA Open. Then, connect the VISA resource name outputs of all the functions with the VISA resource name and connect the error output with the error input, as shown in the figure below.



5. Add string constant in the write buffer areas of the VISA Write function and input the following instructions in the figure below. Waveform data is read through the

VISA Read function which requires users to input the total number of bytes to be read. In this example, the total number of bytes of waveform data to be read is less than 2048. Use the VISA Close function to close the VISA resource after the VISA operation is finished.

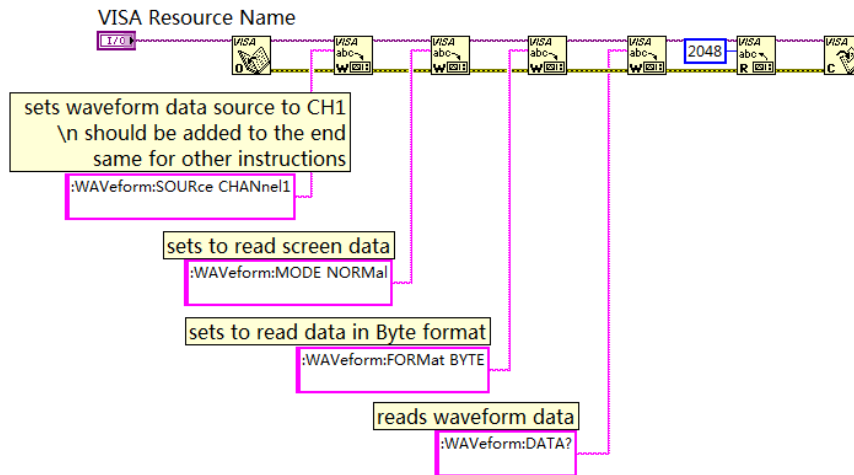

6. The data format is TMC data block header + waveform data + terminator. The TMC header is in #NXXXXXX format; wherein, # is the TMC header identifier; N following # represents the length of the waveform data; the length of the waveform data points is expressed in ASCII strings, and the terminator represents the ending of communication. For example, the data read for one time is #9000001000XXXX. It indicates that 9 bytes are used to describe the data length. 000001000 indicates the length of waveform data, that is, 1,000 bytes. Use the following block diagram to obtain the number of bytes that the TMC header occupies. Ignore the TMC header and delete the terminator at the end of the waveform data, and transfer the waveform data to the byte data and display it on the waveform diagram controls.

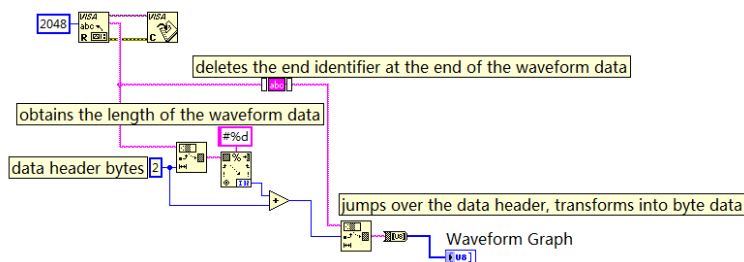

The available functions used in the above block diagram as as follows:

String Subset

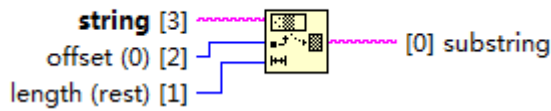

Used to obtain the TMC header "#N". After obtaining the number of bytes that the TMC header occupies, ignore the data header to obtain the waveform data strings

Scan From String

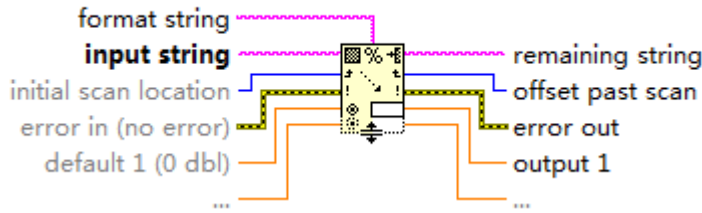

Used to obtain the waveform data length bytes

Trim Whitespace.vi (4803)

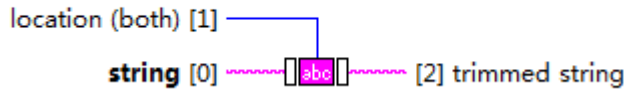

Used to delete the terminator at the end of the waveform data

String To Byte Array



Used to transfer waveform data strings to the byte group

7. The complete program block diagram is as shown in the figure below:

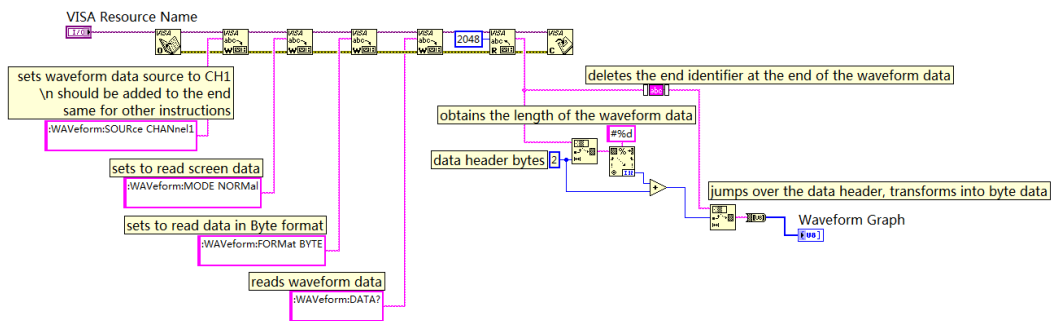

8. Select the device resource from the VISA Resource Name drop-down list and run the program.

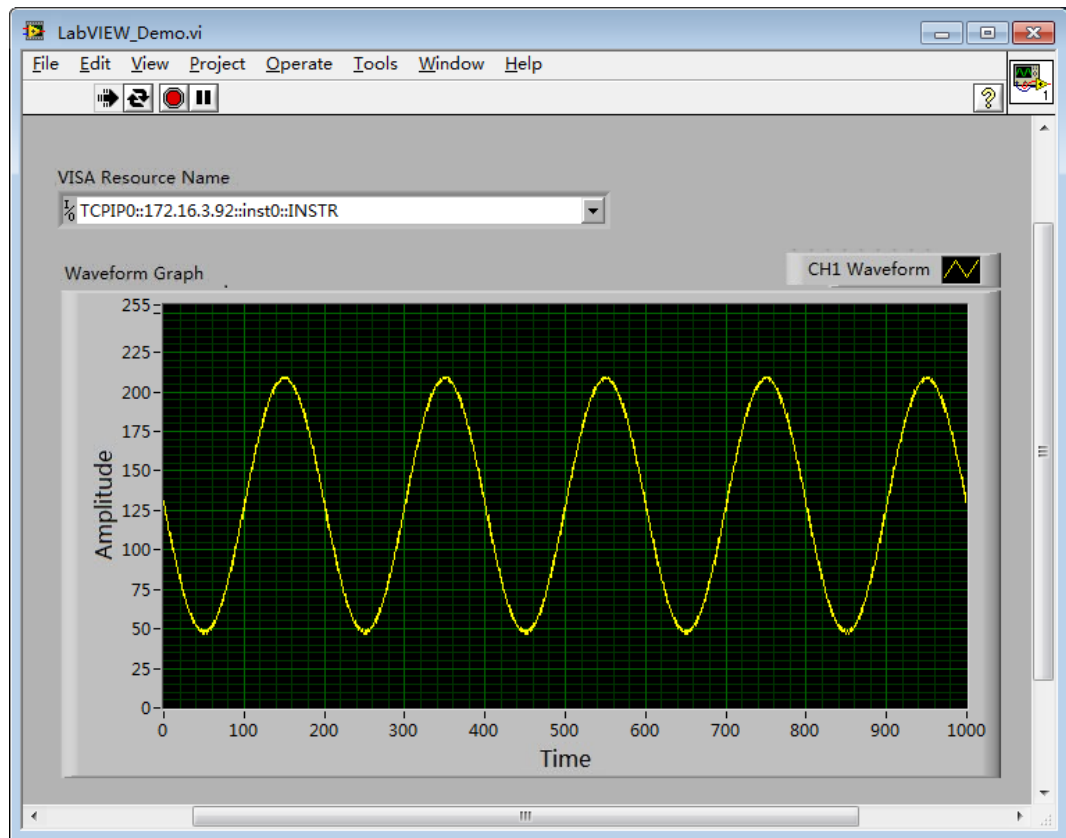

5.3 Visual Basic Programming Example

Program used in this example: Visual Basic 6.0

Function realized in this example: control the on/off state of any channel.

Enter the Visual Basic 6.0 programming environment, and perform the following procedures.

1. Build a standard application program project (Standard EXE), and name it "Demo".
2. Click **Project** > **Add Module** to open the Add Module dialog box. In the dialog box, click the Existing tab to search for the **visa32.bas** file in the include folder under the NI-VISA installation path and add the file.

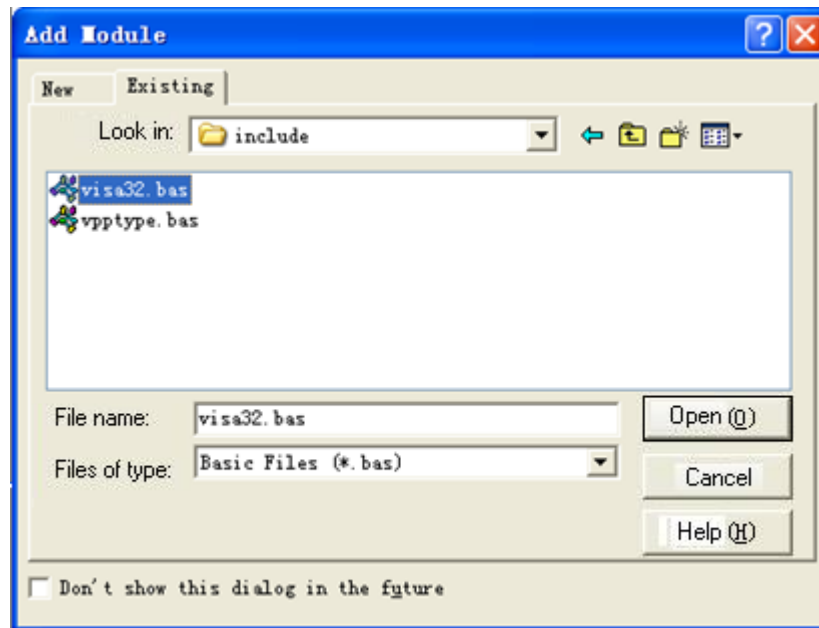

3. In the Demo dialog box, add four buttons to represent CH1 to CH4 respectively. Add four Labels (Label1(0), Label1(1), Label1(2), Label1(3)) to represent the statuses of CH1 to CH4 respectively (when the channel is enabled, it displays the color of the channel; when the channel is disabled, it displays gray), as shown in the figure below.

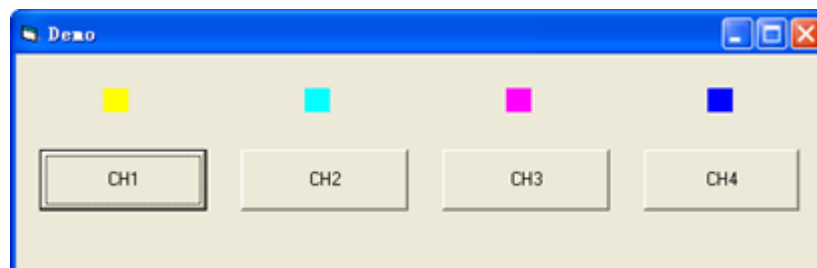

4. Click **Project > Project1 Properties** to open the Project1 – Project Properties dialog box. In the dialog box, click on the General tab and select **Form1** from the drop-down list under Startup Object.
5. Double-click CH1 to enter the programming environment. Add the following codes to control CH1-CH4. The codes of CH1 are as shown below; the codes of the other channels are similar.

```
Dim defrm As Long
Dim vi As Long
Dim strRes As String * 200
Dim list As Long
Dim nmatches As Long
Dim matches As String * 200 'Reserve the obtained device number
Dim s32Disp As Integer
' Obtain the usb resource of visa
Call viOpenDefaultRM(defrm)
Call viFindRsrc(defrm, "USB?*\"", list, nmatches, matches)
' Turn on the instrument
Call viOpen(defrm, matches, 0, 0, vi)
```

```

' Send a command to query the status of CH1
Call viVPrintf(vi, ":CHAN1:DISP?" + Chr$(10), 0)
' Obtain the status of CH1
Call viVScanf(vi, "%t", strRes)
s32Disp = CInt(strRes)
If (s32Disp = 1) Then
' Send the setting command
Call viVPrintf(vi, ":CHAN1:DISP 0" + Chr$(10), 0)
Label1(0).ForeColor = &H808080 'Gray
Else
Call viVPrintf(vi, ":CHAN1:DISP 1" + Chr$(10), 0)
Label1(0).ForeColor = &HFFFF& 'Yellow
End If
' Close the resource
Call viClose(vi)
Call viClose(defrm)

```

6. Save and run the project to obtain a single exe program for demo. When the instrument is correctly connected to the PC, you can control the on/off status of any channel.

5.4 Visual C++ Programming Example

Program used in this example: Visual C++ 6.0

Function realized in this example: search for the instrument address, connect to the instrument, send commands, and read return values.

Enter the Visual C++ 6.0 programming environment, and perform the following procedures.

1. Create a MFC project based on a dialog box.
2. Click **Project > Settings** to open the **Project Setting** dialog box. In the dialog box, click the **C/C++** tab, select **Code Generation** from the drop-down list under **Category**. Choose **Debug Multithreaded DLL** from the drop-down list under **Use run-time library**. Click **OK** to close the dialog box.

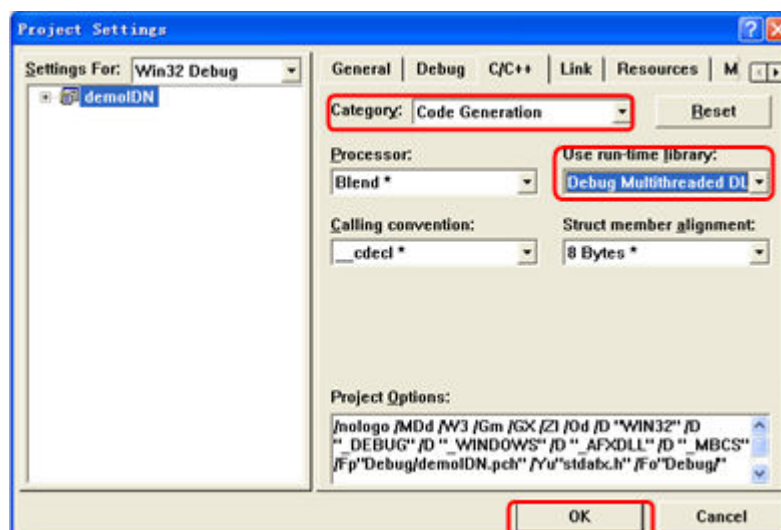

3. Click **Project** > **Settings** to open the **Project Setting** dialog box. In the dialog box, click the **Link** tab, add "visa32.lib" under **Object/library modules**, then click **OK** to close the dialog box.

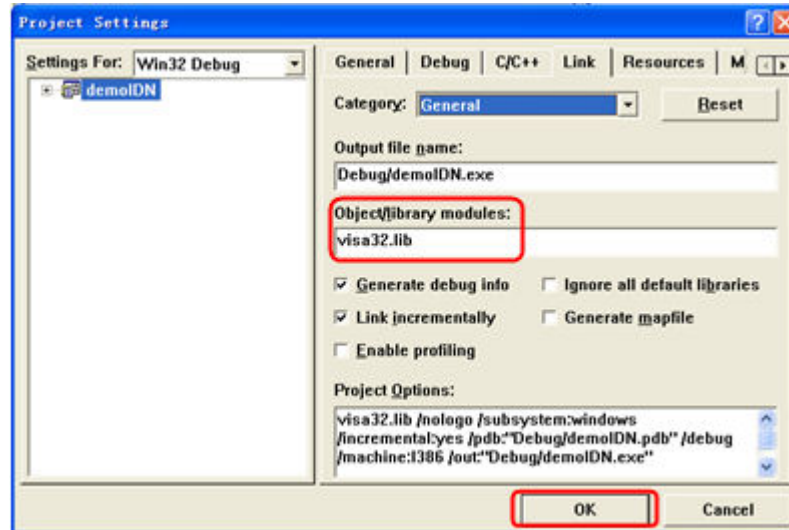

4. Click **Tools** > **Options** to open the Options dialog box. Then click the **Directories** tab.

Select **Include files** from the drop-down list under **Show directories for**. Double click the empty space under **Directories** to enter the specified path of Include files: C:\Program Files\IVI Foundation\VISA\WinNT\include. Click **OK** to close the dialog box.

Select **Library files** from the drop-down list under **Show directories for**. Double click the empty space under **Directories** to enter the specified path of Library files: C:\Program Files\IVI Foundation\VISA\WinNT\lib\msc. Click **OK** to close the dialog box.

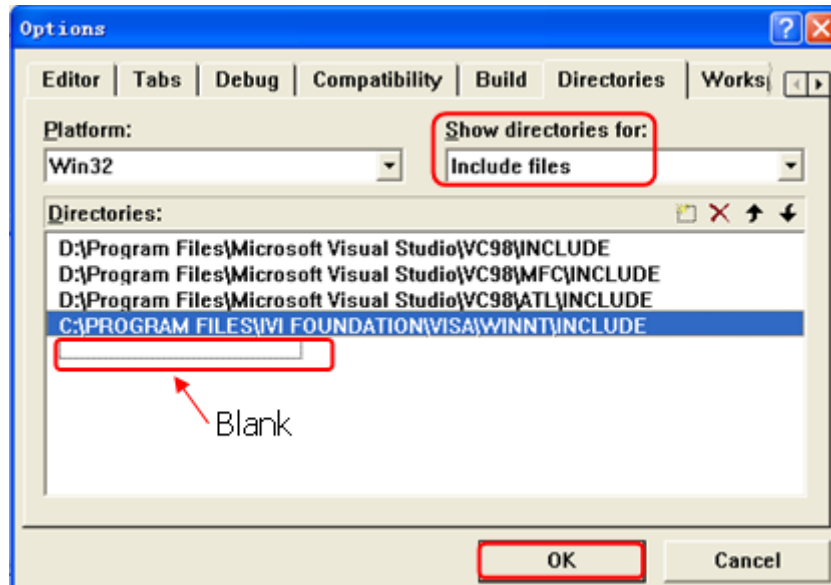

Note: By now, VISA library has been added.

5. Add the **Text**, **Combo Box**, **Button**, and **Edit Box** controls. The layout interface for adding controls is as follows:

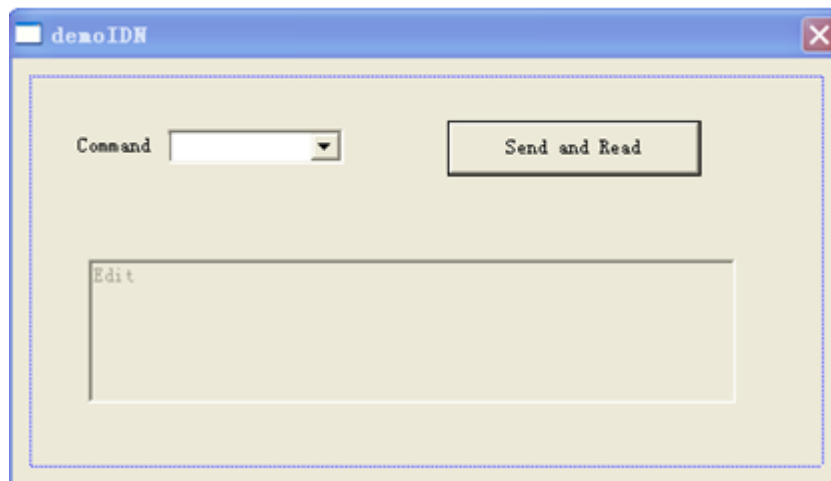

6. Modify the control attributes.
 - a. Name **Text** as "Command".
 - b. Open the **Data** item in the **Combo Box** attribute and input the following command *IDN? manually.
 - c. Open the **General** item in the **Edit Box** attribute and select **Disabled**.
 - d. Name **Button** as **Send and Read**.

7. Add the variables `m_combox` and `m_receive` to the **Combo Box** and **Edit Box** controls respectively.

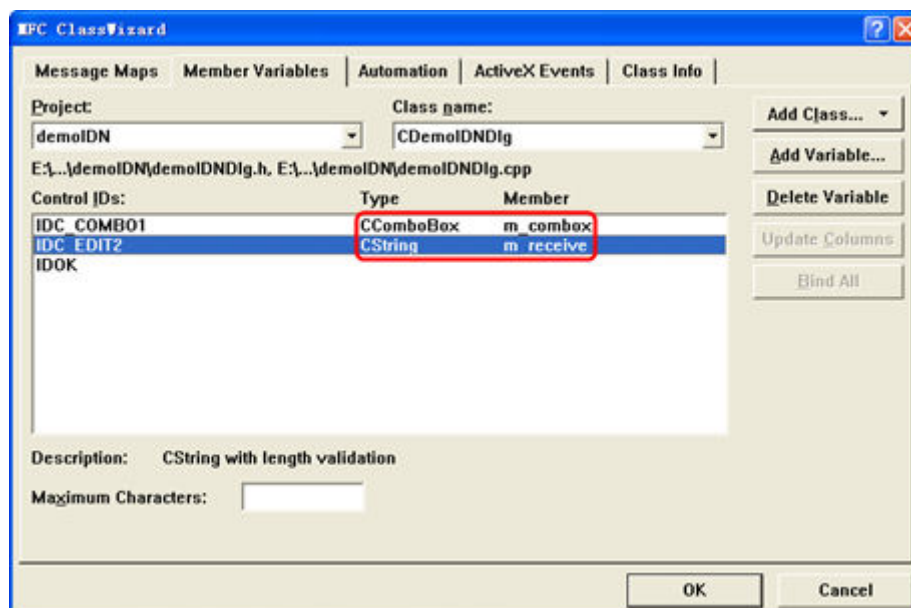
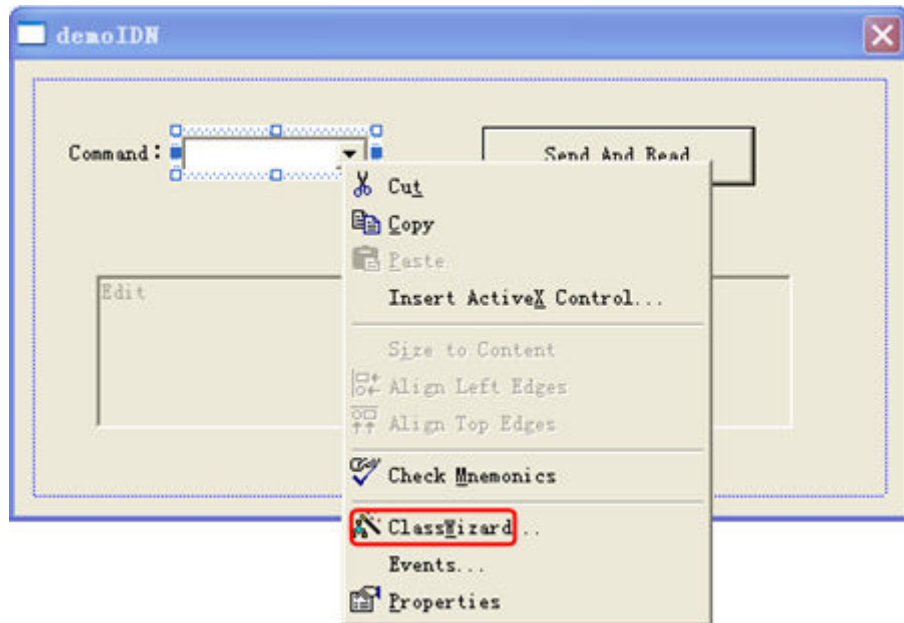

8. Add codes.

Double-click **Send and Read** to enter the programming environment. Declare the `#include <visa.h>` of the VISA library in the header file and then add the following codes:

```
ViSession defaultRM, vi;
char buf [256] = {0};
CString s, strTemp;
char* stringTemp;

ViChar buffer [VI_FIND_BUFLLEN];
```

```
ViRsrc matches=buffer;
ViUInt32 nmatches;
ViFindList list;

viOpenDefaultRM (&defaultRM);
//Acquire the USB resource of VISA
viFindRsrc(defaultRM, "USB?*",&list,&nmatches, matches);
viOpen (defaultRM,matches,VI_NULL,VI_NULL,&vi);

//Send the command received
m_combox.GetLBText(m_combox.GetCurSel(),strTemp);
strTemp = strTemp + "\n";
stringTemp = (char *) (LPCTSTR)strTemp;
viPrintf (vi,stringTemp);

//Read the results
viScanf (vi, "%t\n", &buf);

//Display the results
UpdateData (TRUE);
m_receive = buf;
UpdateData (FALSE);
viClose (vi);
viClose (defaultRM);
```

9. Save, compile, and run the project to obtain a single exe file. When the instrument is correctly connected to the PC, enter a command (for example, *IDN?) and click **Send and Read** to execute the command. Then, the reading results will be returned.

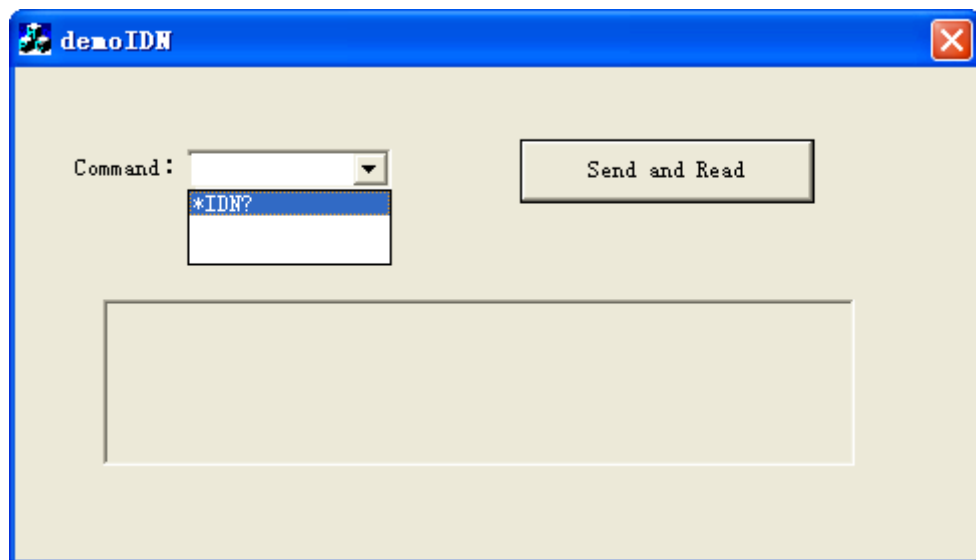

HEADQUARTER

RIGOL TECHNOLOGIES CO., LTD.
No.8 Keling Road, New District, Suzhou,
JiangSu, P.R.China
Tel: +86-400620002
Email: info@rigol.com

EUROPE

RIGOL TECHNOLOGIES EU GmbH
Carl-Benz-Str.11
82205 Gilching
Germany
Tel: +49(0)8105-27292-0
Email: info-europe@rigol.com

NORTH AMERICA

RIGOL TECHNOLOGIES, USA INC.
10220 SW Nimbus Ave.
Suite K-7
Portland, OR 97223
Tel: +1-877-4-**RIGOL**-1
Fax: +1-877-4-**RIGOL**-1
Email: info@rigol.com

JAPAN

RIGOL JAPAN CO., LTD.
5F,3-45-6,Minamiotsuka,
Toshima-Ku,
Tokyo,170-0005,Japan
Tel: +81-3-6262-8932
Fax: +81-3-6262-8933
Email: info-japan@rigol.com

RIGOL® is the trademark of **RIGOL TECHNOLOGIES CO., LTD.** Product information in this document is subject to update without notice. For the latest information about **RIGOL**'s products, applications and services, please contact local **RIGOL** channel partners or access **RIGOL** official website: www.rigol.com